

University of Rajshahi

Rajshahi-6205

Bangladesh.

RUCL Institutional Repository

<http://rulrepository.ru.ac.bd>

---

Institute of Biological Sciences (IBSc)

PhD Thesis

---

2013

# Hatcheries and Hatchery Management in Rajshahi District with Special Reference to the Induced Breeding of the Cat Fish, *Clarias Batrachus* (Lin.).

KAFI, MD. SHAFIUL

University of Rajshahi

---

<http://rulrepository.ru.ac.bd/handle/123456789/748>

*Copyright to the University of Rajshahi. All rights reserved. Downloaded from RUCL Institutional Repository.*

**HATCHERIES AND HATCHERY MANAGEMENT IN RAJSHAHI  
DISTRICT WITH SPECIAL REFERENCE TO THE INDUCED  
BREEDING OF THE CAT FISH,  
*CLARIAS BATRACHUS* (LIN.).**



THESIS SUBMITTED FOR THE DEGREE  
OF  
DOCTOR OF PHILOSOPHY  
IN THE  
INSTITUTE OF BIOLOGICAL SCIENCES  
UNIVERSITY OF RAJSHAHI, RAJSHAHI, BANGLADESH

BY  
**MD. SHAFIUL KAFI**  
M.Sc. (Fisheries), M.Phil.

MARCH 2013

INSTITUTE OF BIOLOGICAL SCIENCES  
UNIVERSITY OF RAJSHAHI  
RAJSHAHI-6205  
BANGLADESH

*Dedicated  
To  
The Departed Souls of My Parents*

## DECLARATION

I hereby declare that the thesis entitled “Hatcheries and Hatchery Management in Rajshahi District with Special Reference to the Induced Breeding of the Cat Fish, *Clarias batrachus* (Lin.)” is the result of my own investigation and findings. I further declare that the thesis has not concurrently been submitted anywhere in part or in full previously for any degree or diploma.

March, 2013  
Third Science Building

  
**Md. Shafiul Kafi**  
Ph.D. Fellow  
Institute of Biological Sciences  
Rajshahi University  
Rajshahi-6205.

## CERTIFICATE

*It is my great pleasure to certify that the work embodied in this thesis entitled "Hatcheries and Hatchery Management in Rajshahi District with Special Reference to the Induced Breeding of the Cat Fish, Clarias batrachus (Lin.)" is the result of investigation of the candidate. The thesis has not been submitted for any degree or prize elsewhere.*

*The candidate has fulfilled all the requirements prescribed by the University for submission of a dissertation for the Ph.D degree.*

Supervisor

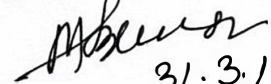
  
31.3.13

**Dr. N.I.M. Abdus Salam Bhuiyan**

Professor (ex-Chairman)

Department of Zoology

University of Rajshahi

Rajshahi-6205.

(Former Professor and Chairman,

Department of Fisheries and Dean,

Faculty of Agriculture, R.U.)



## ACKNOWLEDGEMENTS

All the admirations go to the almighty Allah who has mercifully enabled me to complete this research work.

I express my sincere indebtedness and cordial thanks to my venerable *teacher and Supervisor Prof. Dr. N.I.M. Abdus Salam Bhuiyan*, (ex-Chairman, Department of Zoology and of the Department of Fisheries, University of Rajshahi and also the ex-Dean, Faculty of Agriculture, University of Rajshahi), for his valuable suggestions, scholastic guidance, constant advice, encouragement and constructive criticisms from the beginning up to completion of this dissertation.

I wish to express my sincere gratitude and heartfelt thanks to Professor Dr. M. Khalequzzaman and Professor Dr. Tanzima Yeasmin, the ex and the present Director, Institute of Biological Sciences, University of Rajshahi for providing me laboratory and field facilities to conduct this research work.

I wish to express my sincere thanks to Professor Dr. K.A.M. Shahadat Hossain Mondal, Professor Dr. M.A. Bari Miah, Professor Dr. Md. Wahedul Islam, Professor Dr. Parvez Hasan; Dr. Md. S.M. Shahinul Islam, Dr. Md. Ariful Haque, Assistant Professors, Institute of Biological Sciences for their cooperation and occasional help.

I also want to express my gratitude to Professor Dr. Sowdagar Mahfuzar Rahman former Chairman, Department of Zoology, University of Rajshahi and Professor. Dr. A.S.M. Shafiqur Rahman, the present Chairman of the Department of Zoology, University of Rajshahi for providing me necessary laboratory facilities during the progress of the research work.

I am grateful to the Ministry of Education, Ministry of Public Administration and Director General of Secondary and Higher Education, Govt. of the People's Republic of Bangladesh for granting me deputation for carrying out the research work.

I wish to express my deepest sense of gratitude to the authorities of the Institute of Biological Sciences and to the authorities of University Grants Commission, Agargaon, Dhaka for awarding me a fellowship for the research work.

I am thankful to a number of organizations like - Bangladesh Fishery Research Institute (BFRI), Bangladesh Agricultural Research Council (BARC), Bangladesh Agricultural University Library, Bangladesh Asiatic Society Library and BANSDOC Library for providing me library facilities for this research work.

I wish to express my gratitude to the owners / operators of the surveyed hatcheries who allowed me to survey their hatcheries and supplied necessary data.

I wish to express my special thanks to Md. Ariful Islam, Proprietor of Arif Matsha Hatchery, Court Station, Rajpara Thana, Rajshahi to allow me to carry out the induced breeding experiments in his hatchery by providing me all the hatchery facilities.

I express my cordial thanks to my colleagues of the Department of Zoology, Joypurhat Government College, Joypurhat, for their support and cooperation in many ways.

I also want to express my cordial gratitude to my friends and the proprietor of Impel Computers, Md. Humayun Kabir Prince, Kazla, Rajshahi and the proprietor of Computer Land, Md. Zohurul Islam Babu, 131 Stadium Market, Rajshahi University who were kind enough to compose and print this dissertation.

Last, but not the least I am thankful to those who helped me directly or indirectly in preparation of this dissertation.

I pray to Allah whole-heartedly for the departed souls of my parents.

I cordially extend my gratitude to my beloved wife and affectionate daughter for their great patience, cooperation and encouragements to complete this thesis.

- Md. Shafiul Kafi

## ABSTRACT

Hatcheries and hatchery management in Rajshahi district with special reference to the induced breeding of the cat fish *Clarias batrachus* (Lin.) was studied during the period from January 2010 to December 2011.

Eighteen (16 private and 2 govt.) fish hatcheries were purposively selected from Rajshahi district of Bangladesh to investigate the socio-economic condition of farm owners, limnological condition of waters, infrastructural and other facilities of hatcheries, costs and returns of hatcheries and problems and constraints involved in hatchery business. In this regard it was found that the maximum hatcheries (27.77%) were established in 1991-1995. Most of the hatchery owners (50.00%) earned their livelihood only from hatchery business. 27.78% of hatchery owners had high school level education and 27.78% had Bachelor's and Master's level education. Maximum (88.89%) hatchery operators received training about hatchery management. Most of the hatchery owners (55.56%) had own land and capital (38.89%) to establish the fish farms. They used normally van (non-mechanized vehicles) and *tempo*, motorcycle as mechanized vehicles to carry the fry and brood fishes. Most of the hatchery owners were satisfied for the limnological and soil condition of the hatcheries and communication (55.55%) facilities. They had both skilled and unskilled persons in hatcheries. The average monthly salary of skilled persons was 6652.174±1256.21 Taka and mean daily salary was 156.667±12.111 for unskilled person. The maximum area of the hatchery in the surveyed region was 15.0 decimals and the minimum was 3.75 decimals. Every fish hatchery owner had their own brood stock ponds and that ranged from 2 to 8. 83.37% owners reported about the seldom attack of fish diseases in their hatcheries. Most of the hatchery owners reported that they used only underground water. All the hatcheries had overhead tanks, houses/cisterns and jars/bottles. 8 hatcheries had circular hatching tanks and only 4 hatcheries had circular



breeding tanks. They used chemicals to clean or hygiene the overhead tanks, breeding tanks, houses, jars etc. regularly. Most of the hatchery owners collected brood fishes from their own sources. They stocked 5 native species, i.e. rui (*Labeo rohita*), catla (*Catla catla*), mrigel (*Cirrhina mrigala*), calibaush (*Labeo calbasu*) and bata (*Labeo bata*) and 5 exotic species i.e. silver carp (*Hypophthalmichthys molitrix*), bighead carp (*Aristichthys nobilis*), grass carp (*Ctenopharyngodon idella*), common carp (*Cyprinus carpio*) and raj puti (*Puntius gonionotus*) in a proper density and reared these with supplementary feeds. Oil cake, rice bran, boiled rice, wheat bran, blood wastage, flour, fish meal etc. were used as supplementary feeds and different fertilizers were used for brood fish rearing. Brood fishes were conditioned before induced breeding. Maximum (50.00%) hatchery owners collected eggs from brood fishes 2 times. They used PG and HCG as inducing agents. The total fry production of 18 hatcheries was 8,200 kg in 2010 and 8,380 kg in 2011. Most hatchery owners answered rui (*Labeo rohita*) as the most demandable species (33.33%). 50.00% fry was marketed in the Rajshahi district. Highest price of spawn was found for rui, catla and silver carp and lowest price for raj puti. The net profit was in between 2.697 lakh Taka to 7.361 lakh Taka in 2010 and in between 2.928 lakh Taka to 7.792 lakh Taka in 2011. In general hatchery owners received highest prices of spawn at the start of season and the prices gradually dropped down to the end of the season. The production time of hatchlings normally starts in March and ends in August except common carp. It breeds all the year round. The problems of hatchery owners have been categorized into 4 types such as technical, economical, social and natural. These problems could be solved by providing soft loan to poor owners, ensuring proper training for hatchery owners/operators.

The experiments on the induced breeding of the catfish, *Clarias batrachus* was carried out from April to July of 2010 and 2011 in two breeding seasons. Five different doses of PG (pituitary gland extract) and

HCG (human chorionic gonadotropin) hormone i.e D<sub>1</sub>, D<sub>2</sub>, D<sub>3</sub>, D<sub>4</sub> and D<sub>5</sub> were applied in each month and the effect of the doses were observed on percentage of egg release, fertilization, hatching and survivability. The optimum doses were selected finally on the basis of high production of spawn. The highest response in *C. batrachus* was found in the months of April, May, June and July by using the PG doses of D<sub>4</sub> at the rate of 35.00 mg/kg body weight (1<sup>st</sup> injection as 15.00 mg/kg and 2<sup>nd</sup> injection as 20.00 mg/kg body weight). So the dose D<sub>4</sub> was found to be the most effective as optimum dose. Similarly in case of HCG the best response was found in the months of April, May, June and July with the dose of D<sub>3</sub> at the rate of 3.00 i.u./100g body weight. Therefore the dose D<sub>3</sub> was selected as the optimum dose for *C. batrachus* in this experiment.

## CONTENTS OF THE WORK

<b>Acknowledgements .....</b>	<b>i-ii</b>
<b>Abstract .....</b>	<b>iii-v</b>
<b>Chapter-1: General Introduction .....</b>	<b>1-8</b>
1.1 Fisheries resources of Bangladesh .....	4
1.2 Fishes and fisheries production of Bangladesh .....	6
1.3 Contribution of fisheries sector to the economy of Bangladesh .....	7
1.4 Objectives of the study .....	8
<b>Chapter-2: Review of Literature .....</b>	<b>9-37</b>
2.1 Hatchery Management .....	9
2.2 Induced Breeding .....	19
<b>Chapter-3: Hatcheries and Hatchery Management .....</b>	<b>38-107</b>
3.1 Introduction .....	38
3.1.1 History of fish culture in Bangladesh .....	39
3.1.2 What is fish hatchery and essential components of a fish hatchery .....	40
3.1.3 Models and functions of hatcheries .....	41
3.1.4 Requirements for a fish hatchery .....	44
3.1.5 Hatchery construction .....	45
3.1.6 Present status of hatcheries and hatchlings production of Rajshahi district .....	48
3.2 Materials and Methods .....	50
3.2.1 Selection of the study area .....	50
3.2.2 Location of the study area .....	52
3.2.3 Period of study .....	53
3.2.4 Preparation of survey schedule .....	53
3.2.5 Materials required .....	53
3.2.6 Collection of data .....	54
3.2.7 Processing and analysis of data .....	54
3.3 Results and Observations .....	55
3.3.1 Establishment of the hatcheries .....	55
3.3.2 Occupation of the hatchery owners .....	55
3.3.3 Educational status of the hatchery owners .....	56
3.3.4 Training status of the hatchery owners .....	56
3.3.5 Source of fund for hatchery operation .....	57
3.3.6 Category of land ownership .....	58
3.3.7 Transportation facilities .....	59

3.3.8	Communication facilities of hatcheries .....	59
3.3.9	Status of employees of hatcheries.....	60
3.3.10	Area of hatchery.....	60
3.3.11	Number of ponds in the hatcheries .....	61
3.3.12	Physicochemical and biological characteristic of the ponds.....	63
3.3.13	Occurrence of fish diseases in the hatcheries .....	63
3.3.14	Source of water supply and water discharge system .....	65
3.3.15	Number and water carrying capacity of overhead tanks in the surveyed hatcheries.....	65
3.3.16	Circular breeding tanks.....	67
3.3.17	Circular hatching tanks .....	67
3.3.18	House or cisterns.....	67
3.3.19	Jar or bottles .....	70
3.3.20	Chemicals used for washing tanks, houses and bottles.....	72
3.3.21	Source of brood fishes .....	73
3.3.22	Brood fish stocking and rearing .....	74
3.3.23	Stocking density of brood fishes.....	75
3.3.24	Supplementary feeds used for brood fishes .....	76
3.3.25	Fertilizers used for stocked fishes in the stocking ponds .....	80
3.3.26	Conditioning of brood fishes .....	82
3.3.27	Egg collection time from the brood fishes.....	84
3.3.28	Inducing agents for induced breeding.....	84
3.3.29	Quantity of fry production .....	85
3.3.30	Demand of hatchlings .....	87
3.3.31	Marketing system of hatchlings .....	87
3.3.32	Price of inputs and outputs.....	88
3.3.33	Cost and returns of fish seed production.....	90
3.3.34	Production time of hatchlings.....	92
3.3.35	Problems and constraints faced by private fish hatchery owners .....	92
3.4	Discussion .....	94
3.4.1	Establishment of the hatcheries .....	94
3.4.2	Occupation of the hatchery owners.....	95
3.4.3	Education status .....	95
3.4.4	Training status of the hatchery owners.....	95
3.4.5	Source of fund for hatchery operation .....	96
3.4.6	Category of land ownership.....	96
3.4.7	Transportation facilities .....	96
3.4.8	Communication facilities of hatcheries .....	97
3.4.9	Status of employees of hatcheries.....	97
3.4.10	Area of hatchery.....	98
3.4.11	Number of ponds in the hatchery.....	98

3.4.12	Physicochemical and biological characteristics of ponds.....	98
3.4.13	Occurrence of fish disease in the hatcheries.....	99
3.4.14	Source of water supply and water discharge system.....	99
3.4.15	Number and water carrying capacity of overhead tank in the surveyed hatchery.....	100
3.4.16	Circular breeding tanks.....	100
3.4.17	Circular hatching tanks.....	100
3.4.18	Houses or cisterns.....	101
3.4.19	Jars or bottles.....	101
3.4.20	Chemical used for washing tanks, houses and bottles.....	101
3.4.21	Source of brood fishes.....	102
3.4.22	Brood fish stocking and rearing.....	102
3.4.23	Stocking density of brood fishes.....	102
3.4.24	Supplementary feeds used for brood fishes.....	103
3.4.25	Fertilizers used for stocked fishes.....	103
3.4.26	Conditioning of brood fishes.....	104
3.4.27	Egg collection time from the brood fishes.....	104
3.4.28	Inducing agent for artificial breeding.....	104
3.4.29	Quantity of fry production.....	104
3.4.30	Demand of hatchlings.....	105
3.4.31	Marketing system of hatchlings.....	105
3.4.32	Price of inputs and outputs.....	105
3.4.33	Cost and returns of fish seed production.....	106
3.4.34	Production time of hatchlings.....	107
3.4.35	Problems and constraints faced by fish hatchery owners.....	107

#### **Chapter-4: Induced Breeding of *Clarias batrachus* ..... 108-154**

4.1.	Introduction.....	108
4.1.1	Advantages of induced breeding.....	110
4.1.2	Hybridization.....	110
4.1.3	Cross breeding.....	111
4.1.4	Inbreeding.....	112
4.1.5	Problems and constraints of induced breeding.....	112
4.2	Materials and Methods.....	113
4.2.1	Study area and period.....	113
4.2.2	Selection of brood ponds.....	113
4.2.3	Preparation of brood fish ponds.....	114
4.2.4	Source of brood fishes.....	114
4.2.5	Water qualities of brood ponds.....	114
4.2.6	Maintenance of the brood fishes.....	115
4.2.7	Selection of brood fishes for breeding.....	116
4.2.8	Sex determination.....	116

4.2.9	Characteristics of male brood fish .....	116
4.2.10	Characteristics of female brood fish .....	117
4.2.11	Conditioning of brood fishes .....	117
4.2.12	Formation of set of breeders .....	117
4.2.13	Experimental design.....	118
4.2.14	Source of pituitary gland (PG) and human chorionic gonadotropin (HCG) hormone.....	119
4.2.15	Preparation of PG extract and HCG solution.....	120
4.2.16	Method of injection.....	122
4.2.17	Mode of injection.....	122
4.2.18	Post injection procedure.....	122
4.2.19	Spawning and fertilization .....	123
4.2.20	Incubation and hatching of fertilized eggs.....	128
4.2.21	Spawn rearing and assessment of survivability .....	128
4.2.22	Indices for assessing the effectiveness of different PG and HCG doses .....	129
4.2.23.	Analysis of data.....	129
4.3	Results and Observations .....	129
4.3.1	Effect of different PG doses in different months for the breeding of <i>Clarias batrachus</i> .....	130
(a)	PG doses in April.....	130
(b)	PG doses in May .....	131
(c)	PG doses in June.....	132
(d)	PG doses in July.....	133
4.3.2	Effect of different HCG doses in different months for the breeding of <i>Clarias batrachus</i> .....	138
(a)	HCG doses in April.....	138
(b)	HCG doses in May.....	139
(c)	HCG doses in June.....	140
(d)	HCG doses in July .....	141
4.4	Discussion .....	145
4.4.1	For PG doses .....	145
4.4.2	For HCG doses .....	150
<b>Chapter-5: Summary and Conclusion .....</b>		<b>155-161</b>
<b>References .....</b>		<b>162-180</b>
<b>Appendices .....</b>		<b>181-203</b>

## LIST OF TABLES

		<b>Page No.</b>
Table 3.1	Name of the hatcheries under the Rajshahi District.....	49
Table 3.2	Name of the surveyed hatcheries under the Rajshahi District.....	51
Table 3.3	Year of establishment of the hatcheries in the region under investigation .....	55
Table 3.4	Occupational status of the hatchery owners of the surveyed area .....	55
Table 3.5	Funding source of the hatchery owners of the surveyed area.....	58
Table 3.6	Vehicles used for transportation of brood fishes and spawns by hatchery owners and buyers .....	59
Table 3.7	Communication facilities of the hatcheries.....	60
Table 3.8	Status of staff of fish hatcheries in the surveyed area .....	60
Table 3.9	Area of hatchery in the surveyed area .....	61
Table 3.10	Showing the number of ponds in the hatcheries .....	61
Table 3.11	Showing the physicochemical variables of water bodies in different hatcheries during the period of 2010 and 2011 .....	64
Table 3.12	Occurrence of fish disease in the surveyed hatcheries .....	65
Table 3.13	The brood fishes and their scientific name used for spawning purposes .....	74
Table 3.14	The stocking density of different species of brood fishes .....	75
Table 3.15	Different types of supplementary feeds used in the surveyed hatcheries .....	77
Table 3.16	The use of fertilizers in different hatcheries.....	80
Table 3.17	Duration of conditioning of brood fishes .....	82
Table 3.18	Egg collection time from the brood fishes .....	84
Table 3.19	The hormone used in different species of fishes .....	84
Table 3.20	Quantity of annual fry production in kg in the year of 2010 (January to December) and 2011 (January to December) in Rajshahi.....	86
Table 3.21	Demand of hatchlings of different species.....	87
Table 3.22	Distribution area of hatchlings produced by the hatcheries of Rajshahi .....	88
Table 3.23	Unit price of feed, fertilizers, lime and hormone used by private fish hatcheries in the surveyed area.....	89
Table 3.24	Species wise maximum and minimum price of spawn in the surveyed area .....	90

Table 3.25	Total cost, gross return and net return of fish seed farms in the surveyed area during the period of January, 2010 to December, 2011 .....	91
Table 3.26	Hatchlings production period of different fish species in the surveyed area.....	92
Table 3.27	Problem faced by the owners of fish hatcheries in the surveyed area.....	93
Table 4.1	Water quality variables of brood fish ponds during the breeding season of 2010 and 2011 (April to July) .....	115
Table 4.2	Spawning details of PG doses for <i>C. batrachus</i> in different breeding months of the year, 2010 and 2011 .....	118
Table 4.3	Spawning details of HCG doses for <i>C. batrachus</i> in different breeding months of the year, 2010 and 2011 .....	119
Table 4.4	Effect of different doses of PG on egg release response, fertilization, hatching rate and survivability of <i>Clarias batrachus</i> in different months during the years of 2010 and 2011 (values are arithmetic mean) .....	135
Table 4.5	Effect of different doses of HCG on egg release response, fertilization, hatching rate and survivability of <i>Clarias batrachus</i> in different months during the year of 2010 and 2011 (values are arithmetic mean) .....	142



## LIST OF FIGURES

	<b>Page No.</b>
Figure 3.1 Map of Rajshahi district showing the study areas .....	52
Figure 3.2 Diagram showing the educational status of the hatchery owners (field investigation).....	56
Figure 3.3 Diagram showing the training status of the hatchery owners .....	57
Figure 3.4 Diagram showing the category of land ownership (%) of the surveyed <i>hatcheries</i> .....	58
Figure 3.5 Diagram showing the chemicals used for washing tanks, houses and bottles .....	72
Figure 3.6 Diagram showing the source of brood fishes.....	73
Figure 4.1 Showing the comparative mean value of egg release, fertilization, hatching and survivability of <i>C. batrachus</i> using different doses of PG in the month of April (2010 and 2011).....	136
Figure 4.2. Showing the comparative mean value of egg release, fertilization, hatching and survivability of <i>C. batrachus</i> using different doses of PG in the month of May (2010 and 2011) .....	136
Figure 4.3 Showing the comparative mean value of egg release, fertilization, hatching and survivability of <i>C. batrachus</i> using different doses of PG in the month of June (2010 and 2011) .....	137
Figure 4.4 Showing the comparative mean value of egg release, fertilization, hatching and survivability of <i>C. batrachus</i> using different doses of PG in the month of July (2010 and 2011).....	137
Figure 4.5 Comparative mean value of egg release, fertilization, hatching and survivability of <i>C. batrachus</i> using different doses of HCG in the month of April (2010 and 2011) .....	143
Figure 4.6 Comparative mean value of egg release, fertilization, hatching and survivability of <i>C. batrachus</i> using different doses of HCG in the month of May (2010 and 2011) .....	143
Figure 4.7 Comparative mean value of egg release, fertilization, hatching and survivability of <i>C. batrachus</i> using different doses of HCG in the month of June (2010 and 2011).....	144
Figure 4.8 Comparative mean value of egg release, fertilization, hatching and survivability of <i>C. batrachus</i> using different doses of HCG in the month of July (2010 and 2011).....	144

## LIST OF PLATES

	<b>Page No.</b>
Plate 3.1 a. Hatchery pits, b. Glass jar hatchery, c. Circular hatchery.....	41
Plate 3.2 a. Funnel hatchery, b. Low cost hatchery, c. Mini hatchery, d. Jugar bottle hatchery, e. Bearable hatchery, f. Hapa hatchery.....	43
Plate 3.3 Showing brood rearing ponds .....	62
Plate 3.4 Showing overhead tanks of different surveyed hatcheries .....	66
Plate 3.5 Showing circular breeding tanks of the surveyed hatcheries .....	68
Plate 3.6 Showing houses / cisterns of different surveyed hatcheries .....	69
Plate 3.7 Showing jar/bottles of different surveyed hatcheries .....	71
Plate 3.8 Preparation of supplementary feeds for brood fishes .....	78
Plate 3.9 Supplementary feeds used in the hatcheries- a. Balls; b. Pellets .....	79
Plate 3.10 Types of fertilizers used in the hatcheries- a. Cow dung; b. Poultry waste; c. Urea; d. TSP and e. MoP .....	81
Plate 3.11 Showing conditioning of brood fishes .....	83
Plate 4.1 a. Apparatus and equipments for injection for induced breeding; b. Preservation of PG glands in jars; c. Counting of PG glands; d. Grinding of PG for injection; e. PG. solution and f. Preserved HCG in vials or amples .....	121
Plate 4.2 Adult brood fish ( <i>Clarias batrachus</i> ) and weighing of the brood fishes .....	124
Plate 4.3 Injection procedure of <i>Clarias batrachus</i> .....	125
Plate 4.4 Stripping of female <i>C. batrachus</i> .....	126
Plate 4.5 Showing the dissection of testes of male <i>C. batrachus</i> .....	127

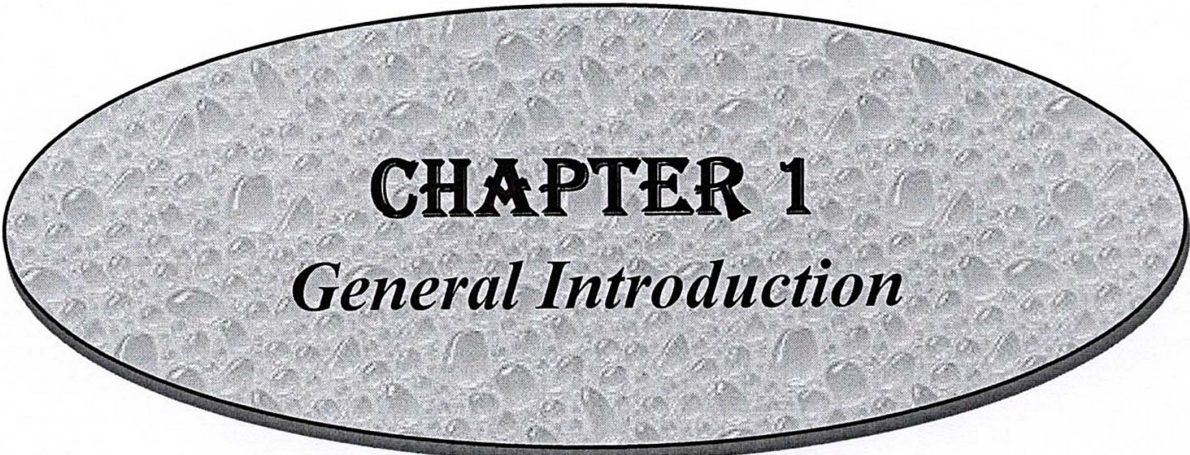

**CHAPTER 1**

*General Introduction*

# CHAPTER 1

## INTRODUCTION

### 1. General Introduction

Bangladesh is an agro-based developing country. Agriculture is the single largest producing sector of its economy. Fisheries is one of the major components of agricultural activities and plays a vital role in supplying nutrition, employment, income generation and foreign exchange earnings of Bangladesh. As the population of Bangladesh is increasing the demand for fish is also increasing and the present fish production is unable to cope up with the ever increasing need for fish. The annual per capita fish need is 20.44kg but we get 18.94kg (DoF, 2011).

Fishes form an important item of human food and a rich source of protein. It is well known all over the world for its high nutritive values. Mannan (1977) demonstrated the speciality of fish protein which is the next to meat. Fish is an important source of protein which provides 63% of animal protein to human (Chaudhuri, 2001). Approximately 80% of the animal protein comes from fish because of poor production and high price rate of egg and meat in our country (Rubbi *et al.*, 1987). According to Samad (1968) fish contains 72-80% water, 15-25% protein, 8% fat, 0.05% calcium, 0.25% phosphorus and 0.1% vitamin. According to a nutritional survey, approximately 30,000 children are becoming blind each year, due to vitamin 'A' deficiency in this country (Thirsted *et al.*, 1997). Fish contains all the essential amino acids in desirable concentration for human being and available at cheaper rate (Menon, 1991). Fish also contains a lot of vitamin 'A' and 'D', fats, carbohydrates and  $\omega$ -3 fatty acid (Gerking, 1967).

Bangladesh is a south-Asian country and located between north latitude 20°34' to 26°38' and east longitude 88°01' to 92°41'. The area of the country is 147,570 km<sup>2</sup>, of which 7% is permanently under water (BBS, 2007). The country is criss-crossed with hundreds of rivers, rivulets and their branches that drain into the Bay of Bengal.

Bangladesh is one of the richest countries in the world in respect of her vast and diverse inland water bodies in the form of rivers and their tributaries, rivulets, flood plains, canals, beels, haors, ponds, ox-bow lakes, coastal areas and the vast Bay of Bangle.

The climatic condition of Bangladesh is characterized by hot, rainy, humid summer and dry mild winter, which are very much helpful for culturing fishes. The main sources of fish seeds in Bangladesh are spawn collected from rivers and those produced in public and private hatcheries. The major input in culture fishery is the quality fish seeds and the expansion and development of aquaculture production depends mainly on the availability of quality fish seeds.

In our country the pond cultural species are the major carps, minor carps, catfishes and prawns. The coastal areas and different type of polders are used to culture the prawns. Derelict ponds and marshy lands are not suitable for culture of carps. It was observed that the production of live fishes (koi, shing and magur) was maximum 2.41% of total fish production (DoF, 2011). In this context magur, *Clarias batrachus* (Lin.) is a promising species for culture in such waters, due to the presence of accessory respiratory organs, which allow them to thrive in waters with low oxygen levels. These fishes have ability to survive in adverse limnological as well as hydrological condition such as high temperature, drought condition etc. They also thrive and grow well in rice fields. In addition, culture of magur can also be taken up in ponds either in combination with carps or alone. The species is very popular among people and fetches a high price in market. As food it is considered highly nourishing, palatable and has reputation as a tasty fish. It is much esteemed as food for convalescents and invalids (Bhuiyan, 1964).

*Clarias batrachus* (Lin.) is a catfish. In Bangladesh it is usually called 'magur' or jagur and it is one of the important food fishes in Asia and Africa. Under this genus *Clarias* there are about 32 species all over the world (Talwar and Jhingran, 1991). In Bangladesh the family Claridae has only one native species,

the *Clarias batrachus* (Lin.). This species is distributed in the rivers, ponds, pools, beels, ditches and brakish waters throughout Bangladesh, India and Burma. Except *C. batrachus* there are 4 other species of *Clarias* available in Indo-Pak-Bangla subcontinent (Day, 1958) as below:

1. *Clarias jagur*,
2. *Clarias teysmanni*,
3. *Clarias dussumieri* and
4. *Clarias assamensia*.

#### **Systematic position of *C. batrachus***

Phylum	:	Chordata
Sub. Phylum	:	Vertebrata
Group	:	Gnathostomata
Super Class	:	Pisces
Class	:	Osteichthyes
Sub Class	:	Actinopterygii
Order	:	Siluriformes
Family	:	Claridae
Genus	:	<i>Clarias</i> (L.)
Species	:	<i>Clarias batrachus</i> (L. 1758)

The fish production from open water has dramatically decreased due to some man made and natural causes. The open water capture fisheries in Bangladesh is under great stress and their sustainability is in danger because of changing catchments, ecology, soil erosion, siltation, construction of flood control and drainage structures and wash of agrochemical and industrial pollutants. The reduction of the natural flow of waters of the Ganges due to the Farakka Dam/Barrage has also affected agriculture, fishing, and boating (Moula, 2011) in Bangladesh. So it is necessary to increase the number of fish farms and hatcheries to increase the production of fish. Hatchery is such a place where there is the arrangement for hatching of fish eggs upto fingerlings stage or

production of fish spawn for suitable stocking in ponds. The hatcheries are presently contributing about 98% of the total spawn production, with the remaining negligible proportion of the spawn coming from natural sources, mainly from rivers and their tributaries (Banik and Humayun, 1998). Therefore, hatchery facilities should be developed to supply sufficient quality fish seeds needed for freshwater and brackish water aquaculture development.

### **1.1 Fisheries Resources of Bangladesh**

Bangladesh is known as the biggest delta in the world. It is a country of rivers, rivulets and tributaries. From the very ancient time Bangladesh is full of fisheries resources. The country is fortunate in having a number of rivers about 700 with their branches and tributaries, canals, haors, baors, dighis, ponds, tanks, lakes and vast fishing ground of the Bay of Bengal. The soil, water and climate of Bangladesh are unique for fisheries.

The country is gifted with rich fishery resources, inland and marine waters with a wide variety of indigenous and exotic fish fauna. The resources of Bangladesh fisheries are also rich. According to DoF's (2011) report there are a total of 260 species of freshwater fin fishes, 12 species of exotic fishes and 60 species of prawns and shrimps. In addition 475 species of marine fishes have been reported from the Bay of Bengal (DoF, 2011).

The total inland water area is about 4,652,665 ha of which 627,731 ha are closed water bodies (ponds and ditches covering 350,595 ha, ox-bow, lakes 8,556 ha, semi closed water bodies 22,382 ha and shrimp farm 246,198 ha) and 40,24,934 ha of open water bodies (river and estuary 853,863 ha, beel 114,161 ha, Kaptai lake 68,800 ha, flood plain 28,10,410 and the Sunderbans 177,700 ha) (DoF, 2011).

Fisheries sector of Bangladesh is mainly divided into two types: the capture fishery and the culture fishery. In the early 1960 capture fishery contributed a major fraction in respect to total fish production. But recently the production from

capture fishery is not satisfactory because of declination of the open water bodies. So we have to depend on culture fishery in inland closed water bodies to meet up the increasing demand of fishes.

The fish fauna of Rajshahi district is uniquely rich because of the presence of a large number of rivers, beels, swamps, ponds, streams and the Padda (Padma), Mahananda, Atrai rivers and other tributaries. Bhuiyan *et al.* (1992) recorded one hundred and thirty three species of fishes belonging to 73 genera, 32 families, 12 orders and 2 classes from different parts of Rajshahi.

Pond is an important source of inland closed water fish production. The total number of pond in Bangladesh is estimated to be about 12,88,222, where in Rajshahi the number is 2,20,590 (Khaleq, 2002). The pond culture in Bangladesh is mostly done with carps but recently the fish “Magur” and “Sing” are commercially brought under culture practice. Islam (1983) identified *Clarias batrachus* as one of potential culturable species in Bangladesh. The major input in culture fishery is to produce quality fish seeds. In Bangladesh artificial breeding of endemic carps has become a common practice since 1967 (Ali, 1967). During 1970s the public sector of the country began producing quality fish seeds through artificial breeding techniques in government fish farms by establishing a number of fish hatcheries. During the middle of 1980s basic training in fish breeding and hatchery operation and management was undertaken initially by DOF and later by BFRI. The private sector was instrumented in building a good number of hatcheries. During 2009-2010 the public and private sectors established 119 and 931 hatcheries respectively (DoF, 2011). The number rapidly increased during the last 20 years with the private sector predominating in the development of fish hatcheries in the country. But in field investigation some private hatcheries were found to be closed. Recently due to degradation of ecological balance, natural sources of fry collection are declining. So hatchery becomes the most important source of fry production.



## 1.2 Fishes and Fisheries Production of Bangladesh

According to DoF (2011) the total production of fish was about 2,899,198 metric tons in 2009-2010 fiscal year, where 2,381,916 mt was from inland water or inland fisheries (82.15%). Fish production of capture fisheries from open water inland fisheries was 1,029,937 mt (35.53%), where fish production from river and estuaries was 153,695 mt, from the Sundarbans was 8109 mt, from beel 70,209 mt, from Kaptai lake 7,117 mt and from flood plain was 790,807 mt. Fish production of culture fisheries from inland closed water bodies was 1,351,979 mt (46.62%), where fish production from pond and ditches was 1,140,484 mt, from ox-bow lake 46,902 mt, from baor 8,727 mt and from shrimp farms was 155,866 mt. The total fish production from marine water was 517282 mt (17.85%) in 2009-2010 fiscal year. The fish capture by trawler was 34,182 mt and fish capture by artesinal was 483,100 mt (DoF, 2011).

In the FY of 2007-2008, the total fish production was 2,563,296 metric tons (DoF, 2009). The total fish production rate of Bangladesh is increasing. In 2008-2009 it was 5.39% and in 2009-2010 it was 7.32% (DoF, 2011).

Community based fish culture, use of modern technology, stocking of fingerlings, restoration of habitats, establishment of sanctuaries, enforcement of different fish conservation laws and flood plain aquaculture etc. have influenced to increase the total fish production of Bangladesh. The amount of fish capturing from the water resources of Rajshahi district was 259076 metric tons in the year of 1999-2000 (Khaleq, 2002). Hence, fish culture is a potential sector and therefore these water bodies properly should be used for fish culture.

The availability of fish seeds is a prerequisite for fish culture and the demand of such seed is increasing day by day. The main sources of fish seeds in Bangladesh are spawns collected from rivers and those produced in government and private hatcheries. In the north-western region of Bangladesh such seeds are collected from the rivers Padda (Padma) and the Jamuna. Khaleq (2002) reported some other spots of collection which are the

Brahmaputra and Dudhkumar (Kurigram) and Boral (Rajshahi). But the production and collection of hatchlings from natural resources has declined due to environmental changes and man made obstacles. Hence the hatchery automatically becomes the popular place in our country for the production of fish seeds.

In the year 2009-2010, the total spawn production from hatcheries was 467,599 kg, of which 5,592 kg was from public hatcheries, 45,9804 kg was from private hatcheries and 2,203 kg was from natural sources. Total number of fry or fingerling production from private hatcheries was 960.01 crore (DoF, 2011). The hatcheries are presently contributing about 98% of the total spawn production with the remaining negligible proportion of the spawn coming from natural sources, mainly from rivers and their tributaries (Banik and Humayun, 1998). Government hatcheries account for less than 5% of national carp spawn production (Islam and Collis, 1998).

### **1.3 Contribution of fisheries sector to the economy of Bangladesh**

Fisheries sector plays a vital role in the socio-economic development fulfilling the demand of animal protein, opportunity for employment, poverty alleviation of large number of population and earning foreign currency of Bangladesh. Fisheries sector contributes 3.74% to GDP and 2.70% to foreign exchange earnings through export. Fishes provide 58% of national animal protein consumption. Fisheries sector also plays an important role in rural employment and poverty alleviation (DoF, 2011). More than 10% of total population of Bangladesh is directly or indirectly dependent on fishery sector for their livelihood. Despite its relatively small size the fisheries sector is crucially important to Bangladesh because of the following points:

- i. The country has the water resources and suitable climate for increasing the fish production.
- ii. Fish is an important and probably the cheapest source of animal protein.
- iii. The fisheries sector can significantly contribute to poverty alleviation, environmental protection and gainful employment opportunities

Fisheries sector has been earning a huge foreign exchange. Bangladesh exports frozen shrimps, fishes and fisheries products to USA, UK, Japan, France, Hong-Kong, Singapore, Saudi-Arabia and other developed countries. In FY 2009-2010, 77584.12 metric tons of fish and fisheries products were exported from Bangladesh which earned Taka 3408.51 crores (DoF, 2011).

#### **1.4 Objectives of the study**

The objective of the present study is to know the fish production by modern hatchery management techniques and to ensure the production of quality spawn specially of magur (*Clarias batrachus*). For this the present research work was taken and the study was designed to attain the following major objectives:

##### **Hatchery management**

- i. Surveying the hatcheries in the study area.
- ii. To know the present status of hatchery management in the study area.
- iii. To investigate the management practices followed by the farm owners.
- iv. To find out the effective and efficient technique of hatchery management.
- v. To identify the social, economic and technical constraints faced by the hatchery owners in practising fish farming.
- vi. Improvement of the hatchery management technique.
- vii. To formulate some suggestions, policy measures and recommendations preparing a business plan for hatchery business; and
- viii. To develop entrepreneurship in this sector.

##### **Induced breeding of *Clarias batrachus***

- i. To standardize PG and HCG doses for optimum breeding performance of the fish in different months of the breeding seasons under hatchery condition.
- ii. Determination of effective doses of PG and HCG for breeding.
- iii. Pre and post injection procedure of induced breeding.
- iv. To produce the spawn of *Clarias batrachus*.
- v. To ensure the availability of quality seed.



**CHAPTER 2**

*Review of Literature*

## CHAPTER 2

### REVIEW OF LITERATURE

Various works related to the present research have been carried out in different parts of the world. Some related literature on hatchery management and induced spawning were reviewed and some of them are presented below:

#### **2.1 Hatchery management**

Gill and Motahar (1982) conducted a research on “social factor affecting prospects for intensified fish farming in Bangladesh”. The authors investigated possible social and economic constraints or realizing the enormous potential for intensified fish farming in Bangladesh. Multiple ownership was found to be a major constraint of fish farming. Other problems identified were non-availability of fish fry, lack of technical training for the farmers, shortage of capital and the theft of fishes or deliberate poisoning due to rivalry or even enmity.

Madu (1984) discussed the potentials for marine fish hatchlings production in Nigeria. The development of fish hatcheries and fish fingerling production in Nigeria has all along concentrated largely on the freshwater fish species without paying enough attention to the more numerous fish species that abound in the coastal/marine environment. He tried to highlight some basic technologies (in term of design and management) of marine fish hatcheries based on his experiences in Southeast Asia. Appropriate adaptable technologies for the production of indigenous species such as snappers, groupers etc. have also been discussed. General recommendations were made for marine fish hatchery development in Nigeria.

Jhingran and Pullin (1985) published a hatchery manual for the common Chinese and Indian major carps.

Rahman (1986) explored the main constraints to the development of aquaculture in Bangladesh. The identified constraints were the multiple

ownership of ponds, land use and land-lease conflicts, lack of adequate credit facilities, short term lease of water bodies, marketing problem and lack of adequate extension services.

Islam and Dewan (1986) studied the economics of pond fish culture in some areas of Bangladesh. They found that pond fish production was mainly based on stocking of fry and fingerlings, use of fertilizer and human labour for different operations and management. All the farmers cultured different types of carp fishes and yielded 816 kg/ha/yr in different locations. Except the higher yield, price of the product and economic use of the inputs had significant impact on net income.

Rahman *et al.* (1987) did a baseline survey of spawn buyers at the Freshwater Aquaculture Research Station hatchery, Mymensingh. Questionnaires were taken on 54 individuals during the 1986 fry production programme at the Freshwater Aquaculture Research Station (FARS), Mymensingh. On analysis, 45% claimed fish farming as their major occupation. The average number and total areas of ponds owned were 6.6 and 0.9 ha, respectively. 73% produced only fingerlings and preferred rui and silver carp. 98% supplied supplementary feeds in the form of oil cake. Comparing the average purchase of 356,000 spawns with the average harvest of 112,800 fingerlings, yields a survival rate of 32% of fingerlings.

Dewan *et al.* (1988) carried out an exploratory trial on composite fish culture in a farmers pond, a public pond and a backyard pond to explore the fish production potentials of the ponds. Five species of fishes viz. *Labeo rohita*, *Catla catla*, *Cirrhina mrigala*, *Hypophthalmichthys molitrix* and *Cirrhina reba* were reared for a period of eight months. Among all the fish species *C. catla* and *H. molitrix* showed the highest growth and *C. reba* showed the lowest growth. The gross yield and the net income per hectare obtained from farmer's, Public (govt.) and backyard ponds during the period of study were 1031kg, 986kg, 687kg and Tk. 28818, 27941 and 15767, respectively.

Uddin *et al.* (1988) conducted an experiment in 3 nursery ponds to study the effect of different types of fertilizers on the growth and survival of rui (*Labeo rohita*) spawn. Three fertilizer doses viz. (i) 15 tons/ha cattle dung, (ii) 112.5 kg/ha urea+37.5 kg/ha triple super phosphate (TSP) and (iii) urea and triple super phosphate at the rate of 75kg/ha each, were tried. Survival of fry in different ponds ranged from 52.1 to 73.3%. Best survival of 73.3% was obtained from the pond which was fertilized with urea and triple super phosphate at the rate of 112.5 and 37.5kg/ha respectively.

Nuruzzaman (1989) described the socio-economic consideration of fish seed production in Bangladesh. He studied those fish farmers who developed their socio-economic condition through fish seed production.

Naser *et al.* (1991) conducted a study on the productivity of water in two monoculture rearing-ponds of catfish (*Clarias batrachus*) fry at Mymensingh, Bangladesh. The productivity of water was found to be high in both empirical (Leger-Huet formula) and analytical or scientific methods in both ponds.

Flid (1992) reported on the extensive fish culture and year calendar.

Warner and Domaniewsk (1993) conducted a research on "fish farming and the environment". They investigated the environmental impacts of fish farming in the UK. They reported that the UK industry was dominated by trout and Atlantic salmon production and intensive methods used could harm the local and wider environment through oxygen consumption, waste production, the spread of diseases and parasites and the introduction and escape into natural waters of farmed stock and exotic species which interact in harmful ways with native fauna. They made suggestions for limiting those impacts.

Chaubey (1995) described the performance of hatchery and field evaluation of Indian major carps.

Bhuiyan (1996) studied the small indigenous fish species (SIFS) of Bangladesh and found that there were about 154 species of fin fishes belonging to

12 orders, 32 families and 73 genera in the north-west region of Bangladesh. He noted that many of the important SIFS were threatened to extinction like *Nandus nandus*, *Colisa fasciata* and *Chaca chaca* etc.

Banik and Humayan (1998) noted that hatcheries were contributing about 98% of the total spawn production with the remaining negligible production of the spawn carrying from natural sources, mainly rivers and their tributaries.

Miah *et al.* (1998) studied the effect of fertilizers on the growth of fishes under carp polyculture system. Three treatments on fertilization were tried with organic manure, inorganic fertilizers and mixed (organic plus inorganic) fertilizers. All the ponds were stocked with Indian and Chinese major carps at 6500 fingerlings/ha. The production of fish obtained 3434.07kg/ha in 10 months from mixed fertilization, followed by 3345.10kg/ha from inorganic fertilization and 2333.40kg/ha from organic fertilization. DNMR test revealed mixed and inorganic fertilization better than organic fertilization.

Penman and McAndrew (1998) discussed the hatchery management, inbreeding and unintentional selection in brood stock, selective breeding in aquaculture and production system for stocking and monitoring and control of quality in hatcheries.

FAO (2000) reported the state of world fisheries and aquaculture.

Mohsin (2000) studied the post stocking management and maintenance of improved traditional carp culture. He worked on 16 sampling ponds at Rajshahi and Natore districts. Post stocking management and maintenance included the use of fertilizer, supplementary feeds and aeration. Fertilizers were used once or twice a month. Urea, TSP or SSP, mustard oil cake, cow dung and compost at an average rate of 756.66, 336.51 or 1217.72, 1804.91, 3997.27 and 2378 kg/ha/yr were used respectively. Supplementary feed was used daily, half weekly or weekly. Rice bran (fine or coarse), wheat bran and wheat flour at an average rate of 1270.84 or 1356.56, 716.45 and 499.92 kg/ha/yr were used



respectively. Lime was used yearly at an average rate of 237.82 kg/ha/yr. The average cost for post stocking management and maintenance was Tk. 32905.28 ha/yr, which was 32.01% of the total production cost and an average net production from these improved traditional post stocking managed ponds was found as 3679.09 kg/ha/yr.

Kabir *et al.* (2001) studied various factors on spawn and fingerlings production in government and private farms. They collected data from 45 private and 11 government farms from 9 selected districts covering major fish seed producing areas of Bangladesh. The study indicated that the variables had some positive impacts on return from spawn and fingerlings. No input was found to be over used and increasing returns to scale. They found that higher amount of input use produced higher level of yield, gross return and net return. The government farms were under utilized. For increased supply of fish seeds in the country more amount of specified inputs (feed and fertilizer) should be used for producing spawn and fingerlings especially in government farms.

Hasan and Ahmed (2002) carried out a case study in 180 hatcheries and nurseries in north-eastern and south-western Bangladesh over a 30 day period during August-September, 1999 to study different aspects of management issues in small scale carp hatcheries and nurseries, with special reference to their health management. Three major carps (ruoi, catla and mrigal) and three exotic carps (silver, grass and common carp) were the dominant fish species cultured in most hatcheries and nurseries. They observed that major source of spawn for nurseries was the hatcheries, while hatchery brood stocks were mostly collected from the farmers grow output ponds. In general hatcheries were more profitable than nurseries.

Miah *et al.* (2002) conducted an experiment to evaluate the profitability of Fish Seed Multiplication Farms (FSMFs) having hatchery, nursery and hatchery-cum-nursery located in the districts of Jessore, Jhenidah and Narail in Bangladesh. The general findings of the study were that the investment in

FSMFs with hatchery, nursery and hatchery-cum-nursery was highly profitable business. The result clearly indicated that the investment in hatchery was the most profitable than those of nursery and hatchery-cum-nursery operations from the viewpoints of individual investors. It was also evident from the study that the investors of FSMFs had currently been facing some crucial problems, which among others were: problems of inbreeding, shortage of brood fishes, incidence of diseases, unavailability of certain inputs and lack of credit.

Muniruzzaman *et al.* (2002) conducted a study for 6 months (April 2001 to September 2001) to investigate the occurrence of ichthyophthiriasis in carp nursery pond in Bangladesh and to determine the suitable control measure for the disease. The highest prevalence was found during the month of July (34-88%) while the lowest was in April (2-14%). The affected fish species were *Cirrhina mrigala*, *Catla catla* and *Labeo rohita* during their fingerling stages. The most affected fish species was *C. mrigala* (40%) in July while 5 to 15% infection was recorded in *C. catla* and *L. rohita*. Treating of the infected fishes with 2mg KMnO<sub>4</sub> suspension and 0.5% NaCl suspension was found to be the most effective treatment where 90% of the fingerlings recovered.

Sarder *et al.* (2002) observed the private hatchery owners perspectives on hatchery management in Bangladesh.

Haque *et al.* (2003) worked on the costs, returns and relative profitability of pond fish and nursery fish production. In order to attain this objective, a total of 70 producers, 35 producing pond fish and 35 producing nursery fish were selected from 6 villages under two upazilas (Sujanagar and Santhia) of Pabna district. It was estimated that per hectare per year gross cost of pond fish production was Tk. 65,918 while gross return and net return were Tk. 91,707 and Tk. 25,789 respectively. Per hectare per year gross cost of nursery fish production was Tk. 87,489. While gross return and net return were Tk. 139,272 and Tk. 51,783 respectively. The findings revealed that nursery fish production was more profitable than that of pond fish production.

In another study Islam *et al.* (2004) investigated water quality parameters of coastal shrimp farms from south-west and south-east regions of Bangladesh. They found water salinity fluctuating from 3.0 to 15.0 ppt in the south-west, whereas it was in between 2.5 to 20.0 ppt in south-east region. Total ammonia nitrogen as recorded in most farms of Cox's Bazar region was higher (0,1160.438 mg/L) than the recommended level of shrimp farming. Mean values of total ammonia nitrogen and total nitrogen at the outlet of shrimp farms were higher than those of inlet in both the regions. Mean values of phosphate phosphorus and total phosphorus at outlet were lower than inlet. Total suspended solids were deposited on the bottom of shrimp farms in both regions which resulted in higher concentration in inlets than outlets in both regions.

Parvin *et al.* (2004 and 2005) conducted a study to assess the relative profitability and factor share of income from fish based alternative farming systems. A two stage stratified random sampling system technique was followed for conducting farm survey of selected 90 farms taking 30 from each of three farming systems during July to December 2004. Evidence showed that most of the selected farmers were engaged mainly in agriculture and their levels of education were above primary level. Majority of farmers allocated their land under more than one farming systems and fish based farming systems were dominated by the larger farm size group. The per hectare net returns were Tk. 63,707, Tk. 16,105 and Tk. 3,611 respectively for alternate rice fish, rice cum fish and only rice farm. The O-R-F farming system had the lower profitability which induced the farmers for shifting their land from rice to fish farming.

Saha *et al.* (2004) conducted an experiment to determine the cost, return and relative profitability of pond fish production of Mymensingh and Jessore districts. It was found that per hectare per year gross cost of pond fish production in Mymensingh and Jessore were Tk. 333457.75 and Tk. 54327.74,

while gross return, were Tk. 434131.16 and Tk. 96640.00 and net return were Tk. 100673.41 and Tk. 42312.26, respectively. The findings of this study revealed that the pond fish production in Jessore district was more profitable than that of Mymensingh district.

Singh *et al.* (2004) worked on water quality management during transportation of fry of major carps, *Catla catla*, *Labeo rohita* and *Cirrhina mrigala*. They studied the effects of various agents viz. tris buffer, zeolite, 2-phenonyethanol and oxlyflow in controlling the development of toxic by-products and maintenance of high dissolved oxygen levels during transportation of fry of major carps *Catla catla*, *Labeo rohita* and *Cirrhina mrigala*.

In 2005 a study was conducted by Amin to assess the existing situation of brood stock management and fish-seed production in private fish seed farms in Bangladesh. The data were collected from 100 private hatcheries and 40 nurseries in seven upazilas under four districts. There was no shed in forty hatcheries and the owners faced many problems. Brood fish ponds were found suitable for rearing brood fishes. About 66% of the hatchery owners collected brood fishes from their own ponds and ponds of neighbouring areas. Activities like pond preparation, manuring and supplementary feeding were done properly but stocking density of brood fishes in 76% of the hatcheries was 3000-7000 kg/h. Infection of argulosis was found in brood fishes of 87% of the hatcheries. About 67% of the hatchery owners practiced inter-species crossing. Major problems faced by the hatchery owners were argulosis of brood fishes, unavailability of pure brood stock, inadequate brood fish ponds.

Steeby and Avery (2005) discussed on broodfish selection and care, brood pond preparation and spawning containers. Hatchery water and troughs, Estimating through requirements, Egg hatching and treatments, Yolk-sac fry, Hatchery feeds, Fry losses, Fry enumeration, Fry transport tanks and general recommendations for channel catfish hatchery managers were also discussed under the heading of 'Channel Catfish Broodfish and Hatchery Management'.

Jewel *et al.* (2006) studied the genetic variation in different hatchery populations of common carp (*Cyprinus carpio*) of Mymensingh district in Bangladesh using microsatellite DNA markers.

Mondol *et al.* (2006) studied the fisheries status of Sariakandi Fish Pass, Sariakandi, Bogra. It was observed that before establishing the Sariakandi Fish Pass about 12 genera of Osteichthyes were found in the Bangali river. At present in the Bangali river about 23 genera of Osteichthyes fishes were available.

Musa and Bhuiyan (2007) described the development of fish culture and role of hatcheries of Adamdighi Upazilla of Bogra district.

Quddus (2007) conducted a study to evaluate the performance of pond fish production and socio-economic characteristics of the pond owners. Farmers had attitude towards fisheries technology adoption but had no adequate farming knowledge. Scientific fish farming system had not developed due to farmer's inadequate socio-economic status and fish farm. Per hectare income decreased with the increase of area of pond both in the extensive and semi-intensive pond fish culture. Semi-intensive culture showed significantly higher per hectare return, than the extensive culture due to efficient use of resources and scientific management. Per hectare gross return of landless farmers was significantly higher than medium and large farmers.

Hossain and Siddiqui (2009) reported the present status of hatcheries and fish production of Rajshahi district.

Rashid *et al.* (2009) carried out a study on fish hatchery and nurseries in Mymensingh. They found in general, the fish hatchery and nursery owners having both hatchery and nursery facilities were financially stronger, well-educated and well-trained than only nursery pond owners in Mymensingh aquaculture region. On the other hand, only nursery pond owners were more experienced in fish seed business than the hatchery owners. Most of the owners were satisfied with existing communication facilities. Lack of technical knowledge was one of the major constraints in the hatchery management.

A comparative study of the aquaculture practices adopted by fish farmers in Andhra Pradesh and West Bengal in India was done by Abraham *et al.* (2010). The study compared the socio-economic profile of the fish farmers and the aquaculture practices of the two leading fish producing states of India, namely Andhra Pradesh and West Bengal. Majority of the respondent farmers of Andhra Pradesh and West Bengal practised aquaculture in owned (84%) and leased (67%) ponds respectively. Although the farmers of both the states cultured carps, differences in farm holdings, size of the pond/farm, species cultured, stocking and stocking density, fish seed procurement, nursery management, feed and feeding management, pond fertilization, harvesting frequency, mode of fish marketing, source of information on aquaculture, fish seeds and disease treatment, perception on aquaculture were noticed. Majority of the farmers in West Bengal (68%) had undergone short-term training in aquaculture and few among them (15%) were graduates. Disease is the major problem faced by Andhra Pradesh and West Bengal fish farmers.

Pheleps (2010) discussed on "Recent advances in fish hatchery management". He opined that the advancement of aquaculture has often been bottlenecked because of the lack of seed, but once that bottleneck was overcome there was rapid growth. Recent examples of advances in hatchery technology leading to increased production are sea bream and Pangas. According to him three areas contributing to the advancement of hatchery management are brood stock management, induced spawning and larval feeding.

Akankali *et al.* (2011) described the fish hatchery management in Nigeria. They found that the fish hatchery management is an efficient tool in intensive fish culture. The vital requirements of a fish hatchery, hatchery construction, concrete tank construction, nursery, rearing and production ponds, fish seed hatchery, hormone in fish spawning, hypophysation, compounds used for induced breeding, hormone administration, spawning and rearing steps in artificial propagation, hatchery management, nursery management are basic elements in effective hatchery management.

## 2.2 Induced Breeding

Khan (1944) after a detailed study of the spawning behaviour of carps at the Chhenawan fish farm, Punjab, concluded that probable factors were the rains accompanied by floods which stimulated the fishes to migrate to the spawning grounds, but the fishes spawned only when the temperature was optimum that is in between 75°F and 96°F. According to him, the oxygen content of water and other physico-chemical constituents of the flood water, were not responsible for spawning.

Chaudhuri and Alikunhi (1957) stated that successful dose for induced spawning varied from 0.5 rui gland for *L. bata* and *L. calbasu* weighing 6 to 8 oz. and 0.04 to 0.08 catla gland for *Cirrhina reba* and *Barbus sarana* of same size, which were preserved in absolute alcohol, single as well as double doses were suggested by him for inducing the same fishes.

Tang *et al.* (1963) while summarizing the work of induced breeding of Chinese carps in Taiwan, stated that the treatment with fish pituitaries in combination with chorionic gonadotropin increased the effectiveness and better success in spawning.

Lin (1965) stated that when two doses of pituitary injections were given for inducing fishes, they might be equal in amount. They also mentioned that the second dose should be given about 6 hours after the first dose at 25 to 34°C.

Ali (1967) described the induced spawning of major carps in ponds. He noticed that males and females were to be selected and isolated in June or July. Pituitary glands should be extracted from mature fishes of the same species that would receive the injection of related species. He also noticed that when the sky was cloudy and pond water temperature between 79° to 85°F having dissolved oxygen of 4-8 ppm or more, male and female fishes should be injected. The second injection should be given 5 to 6 hours after the first injection. 4 to 6 hours after the second injections the fishes would release eggs and milt. He further added that hatching took place after 13-16 hours of fertilization.

Jhingran (1968) noted that widespread rains blowing the breeding ground, high turbidity and slightly lower temperature stimulated carps to breed.

Parameswaran *et al.* (1970) studied the maturation and breeding season of carps in Assam.

Blaylock and Griffith (1971) developed a technique for artificial breeding of common carp (*Cyprinus carpio*) in the laboratory condition which was used in biological testing. He also stated that several thousand eggs could be obtained from one fish and the percentage of hatching obtained by using this technique was exceedingly good.

Sinha *et al.* (1974) found that the Chinese carps (silver carp and grass carp) like Indian major carps breed in bundh type lakes by hormone injection and thus this type of breeding could solve the problem of mass production of these carps.

Thakur (1976) studied the spawning behaviour of *Clarias batrachus*. The fishes were injected by pituitary extract and after the injection of 6 to 12 hours he observed that the fishes showed mating activity. During this period there were repeated mating acts at small intervals.

Harvey and Hoar (1979) described the theory and practice of induced breeding in fish. They discussed broadly about the induced breeding practice of common, Chinese and Indian major carps and also the catfishes.

Rahmatullah *et al.* (1983) studied the induced breeding of *Clarias batrachus* (Linn) by pituitary hormone injection. Pituitary glands of *Catla catla*, *Labeo rohita*, *Cirrhina mrigala*, *Clarias batrachus* and *Rana tigrina* were used in the experiment. Out of 18 pairs tested, 13 pairs responded to the pituitary hormone. Partial spawning took place, in case of two pairs without stripping. The number of eggs produced by female fishes were directly related with the size of the fishes and percentages of fertilization of eggs were found to be dependent on the maturity of the eggs. The period of incubation was 28-29 hours and larval stage continued for 5 days at the temperature of 28°C to 30°C.



Rahman *et al.* (1985) conducted an experiment on induced breeding of indigenous major carps, by pituitary hormone injection. They accomplished the induced breeding of four species of indigenous major carps viz. *Labeo rohita*, *Cirrhina mrigala*, *Catla catla* and *Labeo calbasu* by pituitary hormone injection. In the experiment all the species except *C. catla* were found to be non-species specific with respect to pituitary gland. The period of spawning varied from species to species. It was found to depend on the physiological conditions (maturity of the gonads, fattening conditions and absorption stages) of the recipient fishes. The percentage of fertilization of eggs was found to depend on the gonadal condition of the recipient. The period of incubation was found to be influenced by water temperature. The rate of water flow was also found to have profound effect on the period of incubation and percentage of hatching.

Hussain *et al.* (1987) worked on hormone-induced ovulation and spawning of *Puntius gonionotus* (Bleeker). A total of 21 induced spawning experiments of the fish, *Puntius gonionotus* were conducted during the period 29 June – 28 July 1986. The female fish (230-400g) were given single injection of 2-5 mg acetone dried PG per one kilogram body weight and the male fishes (200-300g) were given only 2mg PG per kilogram body weight. 100% success was achieved in inducing ovulation and spawning occurred in all the injected females. Natural spawning was accomplished in the spawning hapas within 4-6 hrs after decisive injection at the ambient temperature of 27-29°C.

Rahman *et al.* (1988) studied the induced breeding of silver carp (*Hypophthalmichthys molitrix*). They applied 3 different doses of human chorionic gonadotrophin (HCG) and pituitary gland (PG) at the rate of 300 or 400 i.u./kg body weight in a first injection and 1200 i.u. (HCG)/kg or 400 i.u. (HCG) + 3 or 4 mg (PG)/kg body weight in the second injection for female. For male only one injection at the rate of 400 or 300 i.u. (HCG)/kg body weight was given. The number of eggs obtained from a female fish by stripping varied

from 145000 to 430000 with an average of 124191 egg/kg body weight of fish. The average percentages of fertilization, hatching and survival of hatchlings were 78.28, 77 and 69.93 respectively. The incubation period of this fish was found to vary from 19 to 21 hours.

Marte (1989) discussed the hormone induced spawning of cultured tropical finfishes. He reported that catfishes spawned mainly by hypohysation or HCG injection and recent trials using LHRHa have also proved to be successful. For *C. macrocephalus*, a single injection of 0.0026-0.0039 mg/fish or 1.5-2.0 dose units pituitary gland extract (PG) is effective. Doses of HCG reported to be effective are 450-500 IU/fish and 3000-4500 IU/kg. LHRHa at doses of 10, 20 and 30µg/kg was tried, the most effective being 20µg/kg *C. macrocephalus*, spawns form 13-16 hours after hypphysation or HCG injection and 15-18 hours when LHRHa is used.

Cheah *et al.* (1990) injected ten gravid females with a single dose of common carp pituitary hormone (CPH). Before injection, the eggs were light yellow and the diameter ranged from 0.94mm to 1.08mm. Ovulation occurred approximately 12 hours after the administration of CPH. The colour of the eggs turned brown and the diameter ranged from 0.99mm to 1.27mm. The fertilization rates ranged from 10-81%. The eggs hatched after about 30-36 hours of incubation at 26°C to 28°C. The hatching rates ranged from 13-67%.

Knud-Hansen *et al.* (1990) investigated egg hatching, fry growth and survival of the walking catfish, *Clarias batrachus* under hatchery condition in West Java, Indonesia. Spawning was environmentally induced in a specialized breeding pond. Gravid females utilized nests containing kakaban, a fibrous matting from local palm trees (*Arenga* sp.), which facilitated egg collection. Newly hatched fry fed with *Artemia* naupli through day 8 (after hatching), an *Artemia*/cladoceran mix from days 9 to 16, and cladocerans only from days 17 to 23, resulted in over 90% survival of young from hatched eggs.

Naser *et al.* (1990) developed a new methodology on the artificial propagation of catfish *Clarias batrachus*. The artificial propagation of catfish, *Clarias batrachus* was done by 'single dose' and 'double dose' injection methods by HCG as an inducing agent. Aeration and diffusion of water was provided to the broods under the experimental condition, more eggs were released by the induced females under experimental condition than those of under control, whereas the number had been higher in double-dosed control females. The percentage of eggs fertilized and hatching were always higher in experimental condition than in control. As a result more fry were obtained in the experimental condition.

Akhteruzzaman *et al.* (1991) made a study on the induced breeding of *Mystus cavasius*. A total of 33, attempts were made for induced breeding of *Mystus cavasius* during the period of 2 June to 25 July 1989. Females weighing 40-100g each were given single injection of 7-12 mg/kg body weight of acetone dried pituitary gland and male fishes weighing 30-60g each were given a dose of 4 mg/kg body weight. Hundred percent success was achieved in inducing ovulation within 7-8 hours after injection of hormone at the ambient temperature of 27-29°C.

Hoque and Ahmed (1991) worked on the spawning performances in rui, *Labeo rohita* in stagnant water. The female fish was given two intraperitoneal injections (20mg of LH-RH-A per kg body weight in the priming doses and 8mg of carp pituitary homogenate per kg body weight in the resolving doses). The male fish was given only 4mg of carp pituitary homogenate per kg body weight at the time of resolving doses of female. Natural spawning took place in stagnant water in the circular tank within 4-6 hours after resolving dose. 84.64 to 93.03% success in ovulation was achieved in this method of induced breeding within mean air temperature range from 29.00 to 30.6°C and 109-526 mm rainfall.

Kohinoor *et al.* (1991) observed the induced breeding of walking fish, *Anabas testudineus* (Bloch). A total 27 female, *Anabas testudineus* were induced to breed during the period from March to June, 1989. Female fishes weighing 28-80g were given single injection of 8-12mg PG/kg body weight and the male fishes weighing 22-52g were given only 4mg PG/kg body weight. Ovulation occurred in all the injected females. Natural spawning was accomplished in the spawning hapas within 7-8 hours at the ambient temperature of 27-30°C.

Das *et al.* (1992) worked on induced breeding and fry rearing of catfish *Clarias batrachus*. They injected the fishes intramuscularly with HCG at 4500 IU/kg body weight. In case of instantly obtained eggs treated with sperms of different ages (upto 10 minutes) the percentage of fertilization of eggs varied from 40 to 90 and the percentage of hatching from 25 to 75. In case of different ages (upto 30 minutes) treated with instantly obtained sperms, the fertilization of eggs varied from 45 to 90 percent and hatching of the eggs was found to vary from 11.11 to 77.50 percent. In both sets of treatments there were significant differences ( $p < 0.01$ ) in the fertilization as well as the hatching of the eggs.

Haque *et al.* (1995) conducted an experiment in the breeding of the female Chinese carp. They used different hormone doses during breeding season and compared against egg quality of four Chinese carps viz. silver carp, *Hypophthalmichthys molitrix* Val., bighead carp, *Aristichthys nobilis* Val., grass carp, *Ctenopharyngodon idella* Val. and black carp, *Mylopharyngodon piceus* Val. The hormone sources were HCG (Human chorionic gonadotropin) and APC (Acetone-dried pituitary glands of common carps). In the study it was found that the mixture of HCG and APC served better than either HCG or APC alone in the breeding of female Chinese carp. The males always responded with 2.0-2.5g APC/kg body weight to release the milt.

Kohinoor *et al.* (1995) conducted an experiment on the induced breeding of local and Raj sorpunti (*Puntius sarana* Hamilton and *P. gonionotus* Bleeker),

using acetone dried pituitary glands of common carps (APC). The experiment showed that a dose of 6mg APC/kg body weight of female local sorpunti and 5mg APC/kg body weight of female Raj sorpunti was suitable for breeding. Local sorpunti was not induced to breed at low dose of 4mg APC/kg body weight of female and Raj sorpunti at a high dose of 6mg APC/kg body weight of female.

Haque *et al.* (1996) carried out an experiment to assess the effects of different doses of acetone-dried pituitary gland of common carps on spawning and egg quality of major carps at two stages i.e. first at 1-2 hours of post-fertilization, when the eggs got water hardening and then at 16-18 hours of post-fertilization, when larval movement started. A total of 504 individual females of catal (*Catla catla*), rui (*Labeo rohita*), mrigal (*Cirrhina mrigala*) and kalibaush (*L. calbasu*) were used in the experiment. Significant effect of hormone dose was observed in catal and rui both in spawning and egg quality, but in case of mrigal and kalibaush, it was only in spawning.

Islam *et al.* (1996) studied the artificial propagation of black carp (*Mylopharyngodon piceus*). The induced spawning was successfully performed by three successive doses of injections with HCG (Human Chorionic Gonadotropin), HCG + PG (Pituitary Gland) and PG administered to female at the rate of 200 IU, 800 IU+3mg and 3mg/kg body weight, respectively. The female fishes ovulated after 7 to 8 hours of the third injection. Relatively more matured breeders released eggs and milt earlier than less developed gonads. The rate of fertilization ranged between 51.75 - 53.33%. The hatching rate was 32-60% and was inversely related to the number of eggs kept for incubation. The hatching time was found at 19-21 hours after fertilization.

Tripathi (1996) studied the present status of breeding and culture of catfishes in South Asia.

Except fish similar work was done on other species. Saidapur *et al.* (1997) worked on to assess effect of Pregnant Mare Serum Gonadotrophin (PMS), Human Chorionic Gonadotrophin (HCG) and Estradiol-17 $\beta$  (E<sub>2</sub>) on the oocyte recruitment and development in the sexually immature *Rana tigrina*. Sexually immature female bull frogs *Rana tigrina* were treated with 40IU Pregnant Mare Serum Gonadotrophin (PMSG), 40IU Human Chorionic Gonadotrophin (HCG) and 2 $\mu$ g Estradiol-17 $\beta$  (E<sub>2</sub>) alone to see their individual effect on the growth and recruitment of oocytes *in vivo*. Distilled water (0.2ml) was used as vehicle and injections (ip) were given daily for 30 days. All the frogs were autopsied on 31<sup>st</sup> day. No influence was detected histologically in the ovaries of the treated frogs.

Ahmed and Chowdhury (1998) conducted an experiment to evaluate the propagation of common carp (*Cyprinus carpio* Lin.) with hormonal and natural stimuli. The success of breeding of common carp (*Cyprinus carpio*) using hormonal inducement and environmental stimuli was compared. A successful spawning was observed in all the treatment groups, only 66.66% female responded successfully to LHRH-A combined with dompheridone and 83.33% female in natural stimuli. Females induced with LHRH-A and dompheridone found prompt ovulation than that of natural stimulation. But environmentally stimulated females released more eggs than injected female although their survival rate was similar. Comparison between the two approaches under the conditions showed that both were suitable for spawning induction in common carp. However, environmental stimulation was advantageous because of the less labour and lower cost required for ovulation.

Another experiment on the induced spawning of *Labeo rohita* was conducted by Alam and Bhuiyan in 1999. The study was over a period of eight months from April to July 1998-1999 in two breeding seasons. Eight different doses of PG were applied in each month and the effects of doses were observed on percentage of egg release, fertilization, hatching and survivability.

The optimum doses were selected finally on the basis of high production of spawn. The experiments revealed that the same doses were not effective in all the breeding seasons. It was variable in different months.

Mollah and Khan (1999) worked on induced breeding of *Pangasius pangasius* (Hamilton). Four breeding trials were conducted during June-August, 1997. Dry carp pituitary glands (PG) were used as inducing agent for the breeding trials. In each trial, females were treated twice with the extract of PG. They received a first dose of 2mg PG/kg body weight while the second dose varied from 6-10 mg PG/kg body weight given 6-10 hours later. The males were treated with a dose of 2mg PG/kg body weight at the time of second injection of the females. The female was stripped at onset of ovulation. The eggs were fertilized as dry method. Hatching started after 32 hours of fertilization and completed within 40 hours of fertilization at 25-26°C. In their investigation treatment of female *P. pangasius* with 2 and 6 mg PG/kg body weight as first and second injection respectively 6 hours apart was suggested as optimum dose.

Brzuska (2001) conducted an experiment on artificial spawning of carp (*Cyprinus carpio* L). He used aquaspawn and carp pituitary to induce ovulation in females of Lithuanian B. Ovulation stimulation was carried out in carp using carp pituitary (0.3+2.7 mg kg<sup>-1</sup>), Aquaspawn (0.5ml kg<sup>-1</sup>) and Aquaspawn + carp pituitary (0.3ml + 2.7mg kg<sup>-1</sup>). The poorest results of reproduction (the lowest percentage of ovulating females, the lowest weight of eggs and their poorest quality) were obtained after double hypophysation. The best results were obtained by the application of aquaspawn (hormone) alone. The effect of the applied stimulators was statistically insignificant with respect to the weight of eggs, being highly significant ( $p \leq 0.01$ ) with respect to the percentage of fertilized eggs and that of living embryos after 24 and 36 hours incubation.

Hossain (2001) in another experiment studied the artificial breeding and spawn nursing of the enlisted threatened species *Cirrhina reba*. Induced breeding of *C. reba* was done from May to August, 1997. The female was given an initial

dose of 1-2 mg pituitary gland (PG) extract per kg of body weight and a resolving dose of 6-7 mg PG/kg body weight. The males were administered a single dose of 1-2 mg PG/kg body weight. The female and male ratio was slightly less than 1:2. Spawning in all cases was accomplished in the hatching hapas within 4-8 hours after resolving dose to the females at the temperature 26-27°C. Better results were observed using initial dose of 2mg PG/kg and resolving dose of 6mg PG/kg body weight for females and single dose of 2mg PG/kg for males.

Sarkar *et al.* (2001) worked on successful induced spawning and hatching of hill stream carp *Labeo dyocheilus* (McClelland). From their investigation successful breeding of *L. dyocheilus* by intramuscular administration of synthetic hormonal drug, ovaprim was reported. 90-95% fertilization and high rate of hatching was observed.

Das (2002) worked on seed production of magur (*Clarias batrachus*) using a rural model portable hatchery in Assam, India, that was a farmer proven technology. He stocked the brood fishes in a specially prepared fish pond in the month of April. The fishes were fed with a mixture of trash fish and rice bran at 9:1 proportion at about 10% of the body weight of stocked fish daily. Magur that were about one year old and weighing about 100g each was used for induced breeding. Both female and male magur were given single dose of hormone ovaprim at the same time. 18-21 hours after injection the fishes ovulated and the fertilization took place. At a water temperature of 27-30°C, eggs normally batched out within 26 hours. On an average, about 6000-7000 eggs are obtained from a fully ripe female. The fertilization percentage obtained varied from 89 to 96% with an average of 91.36%, whereas the hatching percentage varied between 23 and 75% with an average of 55.10%. An average of 21.55% survival was achieved from spawn to fry stage with a maximum of 34%. Hatching time varied between 23 hours and 26 hours at a temperature of 31-37.5°C and water pH range 7.6 to 8.1.



Haniffa and Sridhar (2002) carried out a study on induced spawning of spotted murrel (*Channa punctatus*) and catfish (*Heteropneustes fossilis*) using human chorionic gonadotropin (HCG) and synthetic hormone (ovaprim). Induced spawning of the spotted murrel (*Channa punctatus*) and catfish (*Heteropneustes fossilis*) was successfully carried out using ovaprim and human chorionic gonadotropin (HCG). Breeders were administered a single intramuscular injection of the hormones at varying dosages. Fecundity in *C. punctatus* was  $3273 \pm 75$  for ovaprim and  $1253 \pm 126$  for HCG, whereas in *H. fossilis* it was  $6692 \pm 790$  for ovaprim and  $82922 \pm 5432$  for HCG. Successful spawning of *C. punctatus* was observed at 0.3 and 0.5 ml/kg body mass for ovaprim and at 2000 and 3000 IU/kg body mass for HCG. For *H. fossilis* successful spawning was observed at 0.3, 0.5 and 0.7 ml/kg body mass for ovaprim and 1000, 2000 and 3000 IU/kg body mass for HCG.

Sharma and Singh (2002) studied the induced breeding of major carps using ovaprim and carps pituitary hormones. A single dose of ovaprim (Dopamine antagonist + Gn RH) was injected 0.2 and 0.25-0.50 ml/kg body weight, respectively. Carp pituitary extract (CPE) was injected at 2-3 and 6-8 mg/kg (4-6 h later) body weight in females and at 2-3 mg/kg in males. Results showed significantly higher spawning in ovaprim than in CPE treated *L. rohita* and *Catla catla*. Ovaprim failed to induced spawning in *Cirrhina mrigala* but CPE induced spawning in 75% of these fishes. The use of ovaprim in induced breeding of *L. rohita* and *Catla catla* was more successful than CPE.

Another experiment was conducted by Mahmood *et al.* (2003). In their experiment two hormones preparation viz. human chorionic gonadotropin (HCG) and pituitary gland (PG) suspension were compared for their efficacy on the breeding performance of the air breathing catfish *Clarias batrachus*. It was found that HCG induced the fish and gave better ovulation response than PG. Both fertilization and hatching of eggs were significantly ( $p < 0.01$ ) higher in HCG treated fish than PG. On all consideration, HCG was found more suitable for induced breeding of *Clarias batrachus* over PG.

Brzuska (2003) conducted an experiment on artificial propagation of African catfish *Clarias gariepinus* to detect the differences between reproduction effects after stimulation of ovulation with carp pituitary homogenate of GnRH-a and dopaminergic inhibitor. The results of controlled reproduction of African catfish (*Clarias gariepinus*) females after ovulation stimulation with carp pituitary (4mg/kg body weight) or with Aquaspawn preparation (complex of GnRH-a and domperidone) (0.5ml/kg) were examined. It was found that after pituitary stimulation 100% and after aquaspawn treatment 87.5% of females yielded eggs of satisfactory quality. In the group treated with synthetic stimulator females yielded eggs of higher weight. After 12, 24 and 28-hours incubation the quality of eggs obtained after aquaspawn treatment was better than that recorded in the case of pituitary application and differences between the results being statistically significant ( $P \leq 0.05$ )

Mahmood (2003) studied the effects of pituitary gland extract doses on the breeding performance of koi fish, *Anabas testudineus* (Bloch, 1792). The experiment was conducted in completely randomized design with nine treatments. Nine doses of PG extract ranging from 0.8mg to 1.6mg/100g body weight were tested. The optimum dose obtained for breeding the fish was 1.2mg PG/100g body weight, where fertilization rate was  $82.00 \pm 2.8\%$  and hatching rate was  $71.00 \pm 3.7\%$ . The different PG extract doses did not affect the ovulation time of the fish.

Mahmood and Shahadat (2003) worked on breeding performance of walking catfish, *Clarias batrachus*. They observed effects of different doses of human chorionic gonadotropin hormone on breeding of *Clarias batrachus*. Five different dosages of HCG (1, 2, 3, 4 and 5, i.u./100g body weight) were tested to determine an optimum dose for induced breeding of the fish. Among the doses tested, highest ( $p < 0.1$ ) fertilization ( $85.89 \pm 3.45\%$ ) and hatching ( $75.79 \pm 1.00\%$ ) rates were found under 3 i.u. HCG/100g body weight. The results suggest that 3 i.u. HCG/100g may be used for artificial breeding of the fish.

Linhart *et al.* (2004) worked on artificial propagation in European catfish, *Silurus glanis* L. with goals to increase collection of sperm and hatching rate. They addressed technical aspects of immobilizing solution (IS), activation solution (AS), process of insemination, activation of gametes and elimination of eggs stickiness with a practical solution for artificial propagation in hatcheries. Spermiation was stimulated and could be sustained over a period of 1 month after weekly carp pituitary (CP) injection of 5 mg/kg b.w. Males produced significantly the largest quantity of sperm,  $0.12-0.13 \cdot 10^9$  spermatozoa per kg b.w., after third and fourth injections. The best IS for sperm was determined as solution containing 170-200 mM NaCl, 30mM Tris-HCl, pH 7 and activation solution for activation of gametes containing 17mM NaCl, 5 mM Tris-HCl, pH 7. The highest hatching success of 82-88% from four individual females were found for sperm number of 800-80,000 spermatozoa per egg, in comparison to 26% hatching at 80 spermatozoa per egg.

Mahmood and Shahadat (2004) worked on the effects of different doses of pituitary gland extract on breeding the gold fish *Carassius auratus*. Five different dosages of carp pituitary gland (PG) extracts were tested. The different parameters of water in the experimental system were maintained at acceptable range for the breeding of the gold fishes. Likewise, the highest hatching rates were also obtained with 3mg and 4mg PG extracts/100g body weight (hatching rates,  $80.67 \pm 1.52\%$  with 3mg and  $80.33 \pm 1.53\%$  with 4mg PG extract/100g body weight). Since, both the doses, 3mg and 4mg PG extract/100g body weight resulted similar breeding performances, these level may be employed for breeding the gold fish.

Rahman *et al.* (2005) conducted an experiment on the artificial breeding of long whiskered catfish, *Spereta aor* and giant river catfish, *Sperata seenghala*. Their findings were the induced breeding of *S. seenghala* was not successful due to lack of knowledge and skill to identify the brood fishes with proper gonadal maturity. Natural breeding appeared to be successful in case of

*S. seenghala* but not in case of *S. aor*. Besides this *S. seenghala* fry were produced through natural breeding. Fingerlings attained an average mean length of 9.01 cm and weight of 3.95g after two months of rearing. The survival rate of *S. seenghala* was 60%.

Rahmatullah *et al.* (2005) carried out an experiment on the artificial propagation and larval rearing of two freshwater eels, *Monopterus cuchia* and *Mastacembelus armatus*. The attempt on artificial propagation of *M. cuchia* and *M. armatus* was not successful but research need to be continued. *M. cuchia* responded to natural breeding in cisterns under environmental manipulation system. Car type and PVC pike were observed to the best shelters for *M. cuchia* and *M. armatus* respectively.

Alam *et al.* (2006) carried out an experiment on spawning behaviour of hormone induced estuarine catfish, *Mystus gulio*. Spawning activities that include pairing, chasing and resting, nudging, and twisting started 5 hours post injection and ended with release of eggs within 1-2 hours of courtship. Three different dosages of "ovaprim" (1ml/kg, 1.5ml/kg and 2ml/kg in a single dose) were used in induced breeding of *M. gulio*. The latency period was less (6-7 hours) with the dose of 1.5 and 2.0ml/kg, while it was more (7-8 hours) with that of 1.0ml/kg. Eggs under all hormone dosages hatched between 18-20 hours after spawning. The hatching rate 1.0, 1.5 and 2.0ml/kg varied from 71.3-72.7%, corresponding to the fertilization rate of 80.7-84.7%.

Bhuiyan *et al.* (2006) worked on the induced spawning of *Puntius gonionotus* (Bleeker) in the months of April, May, June and July 2005. Five different doses of PG were used in the experiment. The doses were D<sub>1</sub>-3.00mg/kg, D<sub>2</sub>-6.00mg/kg, D<sub>3</sub>-9.00mg/kg, D<sub>4</sub>-12.00mg/kg and D<sub>5</sub>-15.00mg/kg body weight. All the different doses were effective equally (100%) in egg release. In the experiment both the males and females were given the first dose but the second injection was given only to the females after 6 hours. The month of June and the dose D<sub>2</sub> (2mg in first injection and 4mg in second injection) were found to be most effective for induced spawning of *P. gonionotus*.

Hossain *et al.* (2006) conducted a study to observe the artificial breeding performance and nursery practices of the threatened indigenous fish species *Clarias batrachus* at Arabpur Fish Farm, Jessore in 2001 and 2002. Ten trial doses of PG used for induced breeding *C. batrachus* were 5.0 to 20.0 mg PG/kg in the first dose and 30.0 to 60.0mg PG/kg in second dose for female. On the other hand, three trial doses were administered to identify a suitable single dose (15.0mg PG/kg) for the male. Artificial breeding was successfully done in *C. batrachus* with 10.0mg of PG/kg body weight in first dose and 45.0mg in second doses for both wild and first filial (F<sub>1</sub>) generation of female.

Marx and Chakraborty (2007) carried out an experiment on the induced breeding and *in vitro* fertilization performance by various inducing agent in catfish, *Heteropneustes fossilis*. Three inducing hormones viz. ovaprim, ovatide and WOVA-FH were injected at the rate of 0.5, 1.0, 1.5 and 2.0 ml/kg body weight in order to induce oocyte maturation and ovulation. After 10-13h of injection at a water temperature of  $27\pm 0.5^{\circ}\text{C}$ , stripping of eggs and *in vitro* fertilization was done. Ovaprim gave maximum (94.62%) hatching rate followed by ovatide (90.33%) and WOVA-FH (77.33%).

Alam *et al.* (2008) observed the preliminary success on hormone induced captive breeding of goldspot mullet, *Liza parsia* (Ham). They made an attempt to breed goldspot mullet, *Liza parsia*. The fish started spawning 35-36 hours after a single dose of 2ml ovaprim per kg body weight. Hatching of fertilized eggs completed within 42-48 hours after spawning. The mean hatching rate (%) was  $71.33\pm 12$  corresponding to the fertilization rate (%) of  $64\pm 12$ . The salinity of both breeding and rearing cisterns was 20‰ and temperature was maintained at 22-23°C.

Bhuiyan *et al.* (2008) determined the pituitary hormone injection doses for optimum breeding performance of *Labeo rohita*. Forty females and eighty males of matured *L. rohita* (weighing 3.12-4.36kg) were induced to breed with

a series of PG doses. These were 1<sup>st</sup> dose of 1.00mg to 5.00mg/kg and 2<sup>nd</sup> dose of 2.00mg to 10.00mg/kg body weight. The optimum responses in different months were achieved with the doses from 6.00mg/kg to 12.00mg/kg body weight and at that doses the fertilization rate was  $80.00\pm 2.14\%$ , hatching  $71.00\pm 2.00\%$  and survivability  $68.50\pm 2.60$  in different months.

Hossain *et al.* (2008) observed the induced breeding of snake head murrel, *Channa striatus* (Bloch, 1793). The breeding was performed with the treatment of pituitary gland (PG) hormone. The females were treated with PG hormone at the rate 40 to 45 mg/kg body and 80 or 90 mg/kg body weight for the first and second dose respectively after an interval of seven hours. The males were treated with PG at the rate of 40, 45 and 60mg/kg body weight. The fishes who received 45mg/kg body weight in first injection and 80mg/kg body weight in second injection gave satisfactory result. The ovulation was recorded after 9-12 hours of the second dose of injection. The average total number of eggs laid by individual female (fecundity) was estimated to be 17223 (9696-22787)/kg body weight. The fertilization rate was observed 35-80%. Hatching occurred within 24-48 hours after fertilization at water temperature of 25-29°C. The percentage of hatching rate varied from 45-82% with an average of 62.33%.

Musa (2008) conducted an experiment to determine the pituitary gland extract (PGE) doses for optimum breeding performance of gulsha tengra, *Mystus bleekeri* (weighting 80-170g) were induced to breed with a series of PG doses by injecting a single dose of 0.6 to 1.50 mg/100g body weight. The optimum dose obtained for breeding was 1.1mg PGE/100g body weight and at that, the fertilization rate was  $76\pm 5.32\%$  and hatching rate of egg was  $79\pm 4.68\%$ . The fish spawned naturally in concrete cisterns after 7-8 hours at an ambient water temperature of 25° to 28°C.

Sahoo *et al.* (2008) conducted an experiment to evaluate the breeding performance of *Clarias batrachus* at different HCG doses and latency period

combination. The breeding performance was judged through weight of stripped eggs and stripping response. The females injected with 1000-3000 IU HCG per kg bodyweight could not be stripped at 11h latency. The weight of stripped eggs increased gradually with the increase of latency period in both 1000 and 2000 IU dose level. Smooth stripping and free flow of eggs were observed when stripped at 3000 and 4000 IU dose levels in combination with 14-23 hours latency periods but a significant decrease ( $P < 0.05$ ) in egg was observed at 5000 IU and 17-23 h latency combination. The stripping response was the highest at 3000 and 4000 IU in combination with 14-23 h latency period. The injection of 3000-4000 IU HCG dose per kg female weight in combination with 14-23 h latency was suitable to get good stripping response for the highest weight at stripped egg in *C. batrachus* during induced breeding operation.

Marimuthu *et al.* (2009) carried out an experiment of spawning performance of native threatened spotted snakehead fish, *Channa punctatus*, induced with ovatide. In their experiment partial spawning was observed with the ovatide dose of 0.2ml/kg body weight and complete spawning was noticed in the medium ovatide dose of 0.4ml/kg body weight and the higher dose 0.6ml/kg body weight administered fish. The highest total spawning fecundity ( $p < 0.05$ ) was recorded when the females were injected with 0.4ml of ovatide/kg body weight than those injected with other doses. The latency period and the number of spawned eggs ranged from 25 to 31h and 1080 to 5814, respectively. The highest fertilization (69.6%) and hatching (91.33%) rates were also observed at the medium dose ( $p < 0.05$ ).

Puvaneswari *et al.* (2009) worked on early embryonic and larval development of Indian catfish, *Heteropneustes fossilis*. They investigated the embryonic and larval development of Indian catfish, *Heteropneustes fossilis* from fertilisation until metamorphosis. The fully matured eggs and sperms were obtained by artificial insemination. The fertilized eggs were demersal, non-adhesive, spherical and brownish green in colour. The average diameter of the fertilized

eggs ranged from 1.30 to 1.50mm. The incubation period was from 23-24h at an average temperature of  $29\pm 1^\circ\text{C}$ . The newly hatched larvae were  $2.5\pm 0.2\text{mm}$  in length.

Mortezavizadeh *et al.* (2010) studied the effect of GnRHa (D-Ala 6, des-Gly 10m GnRHA), LHRH-a (des-Gly 10, [D-Ala 6] LH-RH Ethylamid) and Carp Pituitary in artificial propagation of gattan, *Barbus xanthopterus* (Heckel, 1843). The objective of this study was to assay the effectiveness of a GnRHa, LHRH-A and carp pituitary on spawning success, latency period, working fecundity, fertilization success and hatching rate. The fishes were injected intramuscularly as follows,  $4\text{mg kg}^{-1}$  b.w. of CPE as positive control,  $20\mu\text{g kg}^{-1}$  b.w. of GnRHa,  $20\mu\text{g kg}^{-1}$  b.w. of LHRH-A<sub>2</sub>,  $18\mu\text{g} + 2\text{mg kg}^{-1}$  b.w. of LHRHa in double injection 10h apart and negative control with distilled water. The results showed that CPE was 87.5% spawning success in comparison with GnRHa, LHRH-a. None of the fishes ovulated in the groups of negative control (distilled water), while 1/8 fishes ovulated in the group of LHRH-a and GnRHa (12.5%). 7/8 fishes ovulated in the group of CPE (87%).

Sharma *et al.* (2010) studied the effect of different doses of ovatide on the breeding performance of *Clarias batrachus* (Linn.). They conducted an experiment to evaluate the ovatide doses (0.6, 0.8 and 1.0ml/kg body weight of female) on breeding performance of *Clarias batrachus* in the sub-tropical region of Hisar. The breeding performance was judged on the basis of the total weight of stripped eggs, net fecundity, fertilization, hatching and survival. To judge the egg quality, the percent fertilization, hatching and survival of fry were considered. The results indicated that the total weight of stripped eggs and spawning fecundity were the highest ( $p < 0.05$ ) when females were injected 1ml of ovatide per kg body weight (BW) compared to those injected with other dose levels. The lowest stripping response was observed with injection of 0.6ml ovatide per kg BW of female brood fish. At the 1ml dose, the percentage of total fertilized eggs and hatching were 82.33 and 55.35% respectively, which



were the highest ( $p < 0.05$ ) among all treatments. The net survival of fry was found to be 98.52% at 1ml ovatide per kg BW.

Padmakumar *et al.* (2011) worked on the breeding of endemic catfish, *Horabagrus brachyosoma* in captive condition. Breeding of this catfish was successfully accomplished by inducing agents, viz. carp pituitary extract (CPE) at 50-60 mg/kg body weight or ovaprim, a synthetic analogue of salmon gonadotropin releasing hormone (GnRH $\alpha$ ) 20 $\mu$ g and 10mg (Domperidone on 1ml) at 1ml/kg body weight in single dose. Induced fishes responded well and spawned naturally in 8-14h and the fertilized eggs hatched in 22-29h. Artificial fertilization by stripping was also successful when carried out within 1-2h of the latency period after hormonal manipulation.

# **CHAPTER 3**

## *Hatcheries and Hatchery Management*

## CHAPTER 3

### HATCHERIES AND HATCHERY MANAGEMENT

#### 3.1 Introduction

The major input in culture fishery is quality fish seed and the expansion and development of aquaculture production depend mainly on the availability of quality fish seeds. The main source of fish seeds in Bangladesh are spawn collected from rivers and those produced in government and private hatcheries.

The seed collected from natural breeding grounds have many problems such as predator fish seeds may come along with expected fish seeds, secondly infected and bad quality seeds may come which may seriously affect the scientific fish culture. Moreover, wild seed is collected and handled in crude and unscientific method that leads to a large scale mortality during transportation from collected centres to nursery ponds and also in the nursery ponds after release. Thus, though large quantities of fish seeds are collected from rivers, which affect natural recruitment to riverine fisheries and riverine fish production, its contribution to aquaculture is not commensurate with the efforts. Therefore, hatchery facilities should be enlarged to supply sufficient quality fish seed needed for fresh water and brackish water aquaculture development.

Although culture fishery under scientific management is relatively a new gesture in Bangladesh but it expanded rapidly in the last decade. During 2000-01 to 2009-10 pond fish production increased 615825 mt to 1140485 mt representing more than 8.52% annual increase as against 6.28% increase in overall fish production in the country (DoF, 2002b and 2011). This however created high demand for quality fish seeds. On the other hand, due to some man-made and natural problems, fish seed collection from the rivers declined in recent years.

According to DoF the collection of hatchlings from natural sources was 1872kg in 2007-08, 1875kg in 2008-09 and 2203kg in 2009-10, which is not sufficient to meet up this gap (DoF, 2009, 2010 and 2011). To bridge this gap in supply of quality fish seeds government has established 119 fish seed multiplication farms

(FSMFs) covering almost all the districts in the country. Private entrepreneurs also came forward to produce fish seeds with a remarkable place in it. In 2000-01 there were 779 private FSFMs. This number increased to 931 by the year of 2009-10. As a result production of hatchlings in private sector hatcheries increased from 220217kg (2000-01) to 459804kg (2009-10). Government sector also produced 7040kg, 5550kg and 5592kg hatchling in the year of 2007-08, 2008-09 and 2009-10, respectively. This recorded 10.88% increase in overall supply of hatchlings from private sector during 2000-2010. The scenario indicated high demand for fish seeds in the country. This demand for fish seeds will be increasing further if it is possible to bring all suitable ponds under intensive cultivation (DoF, 2002b and 2011).

It is argued that successful culture fishery depends mainly on the availability of quality fish seeds. Keeping this in view, the present study has been designed to analyse hatchery management as well as productivity of resources used in fish seed production under government and private sectors.

### **3.1.1 History of fish culture in Bangladesh**

Culture of fish is a very ancient trade. Information shows that, culture of fishes began about 2500 BC in Egypt and 2000 BC in China. But in Bangladesh fish culture is very recent one. A fresh foundation of fish culture was laid by Dr. Nazir Ahmed, the former Director of Fisheries. The climate of Bangladesh is unique for aquaculture and fisheries resources management (Chaudhuri, 2001).

Fish culture under scientific management with hatchery produced seeds is relatively a new gesture in Bangladesh, which at the very beginning was fully dependent on seeds collected from rivers, estuaries had coastlines. Production of fish seeds in hatcheries through induced breeding initiated in the country in 1967. Artificial breeding of endemic carps through hypophysation has become to common practice in Bangladesh since 1967 (Ali, 1967). Meanwhile a large number of hatcheries in the private sector (estimated at over 700) have been established with the introduction of artificial breeding of exotic species (Ali, 1998). In the last decade, fish culture under improved management expanded

rapidly. The major input in culture fishery is the production of quality fish seed. In order to ensure the supply of fish seeds it is essential to establish hatcheries.

The number of existing farms and hatcheries for fish seed production is less than the actual requirement of Bangladesh. At present the total number of fish seed production farms is 1050 where the number of government fish seed production farms is 119 and the number of private fish seed production farms or hatcheries is 931 (DoF, 2011).

In the year 2009-10, the total spawn production from hatcheries was 465.396 mt in which 5.592 mt from public hatcheries and 459.804 mt from private hatcheries. Total number of fry or fingerlings production from private hatcheries was 960.01 crore in the year 2009-10 (DoF, 2011). It seems that the establishment of new hatcheries are playing an active role in the fish production

### **3.1.2 What is a fish hatchery and essential components of a fish hatchery?**

#### **What is a fish hatchery?**

Hatchery is a place where there is the arrangement for breeding and hatching of fish eggs upto fingerling stage or production of fish spawn for suitable stocking in ponds. Hatchery includes rectangular tanks, breeding tanks, incubation tanks, overhead tanks, brood fish pond, nursery and rearing ponds and other related materials.

A fish hatchery must have the following facilities:

- i. A hatchery has several brood fish ponds where brood fishes are reared for induce breeding.
- ii. It has several nursery and rearing ponds where spawns are grown to fry and fingerlings.
- iii. It provides proper indoor facility for fish spawning, egg incubation, hatching and rearing the hatchlings to post larval stage.

Fish hatchery means a facility where adult brood stocks are held or where eggs are collected and incubated, or where eggs are hatched or where fishes are reared.

### **Essential components of a fish hatchery**

Hatchery is a technological and expensive matter. It is built of many small units. Generally, breeding and fertilization of fishes, eggs manifestation and ovulation, fry and fingerling rearing etc. are done in a hatchery. The essential part of a modern hatchery are as follows:

1. Hatchery building
2. Tank/tanks
  - i. Storage/reserved tank
  - ii. Fish breeding tank or circular tank
  - iii. Overhead tank
3. Incubation tank (jar or bottle)
4. Spawner
5. Brood fish pond
6. Nursery pond
7. Power pump
8. Aeration device
9. Hatching apparatus
10. Nets for catching of fishes

#### **3.1.3 Models and functions of hatcheries**

According to the choice and ability of the owners, the models of hatcheries are of different types. A hatchery needs different types of tanks or containers for seed production.

Getting success in the induced breeding in Bangladesh, there are different types of models of hatcheries (Siddique and Chaudhuri, 1996; Das, 1997). These models are as follows:

- i. Hatchery pits
- ii. Glass jar hatchery
- iii. Circular hatchery
- iv. Funnel hatchery
- v. Low cost hatchery
- vi. Plastic tube hatchery
- vii. Mini hatchery
- viii. Jugar bottle hatchery
- ix. Bearable hatchery
- x. Hapa hatchery

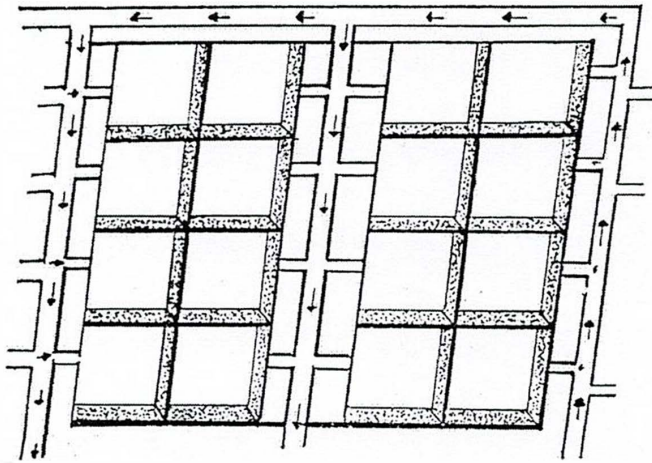

(a)

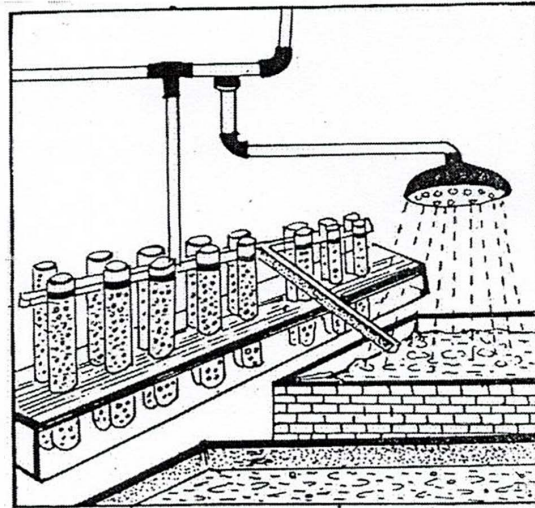

(b)

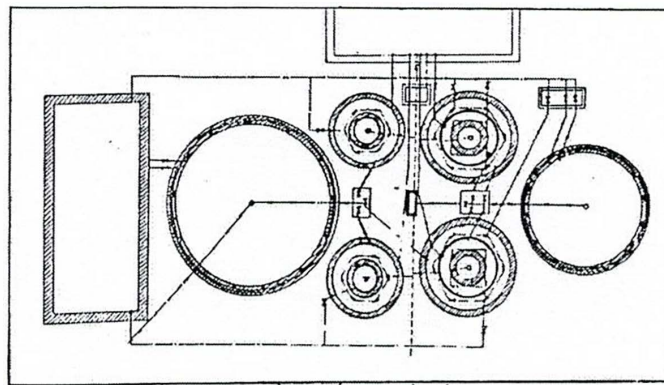

(c)

**Plate 3.1.** (a) Hatchery pits.  
(b) Glass jar hatchery.  
(c) Circular hatchery.

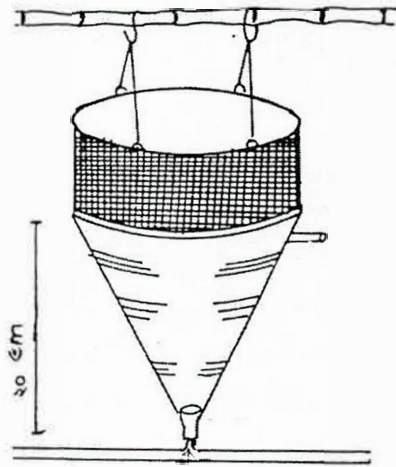

(a)

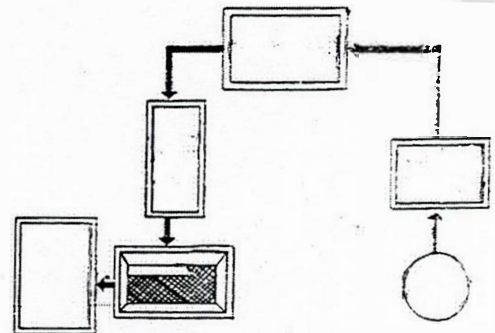

(b)

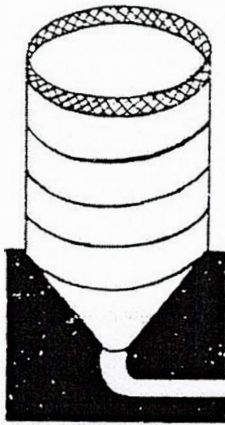

(c)

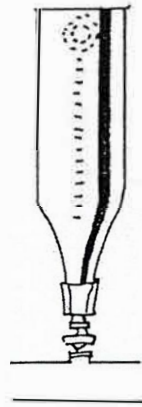

(d)



(e)

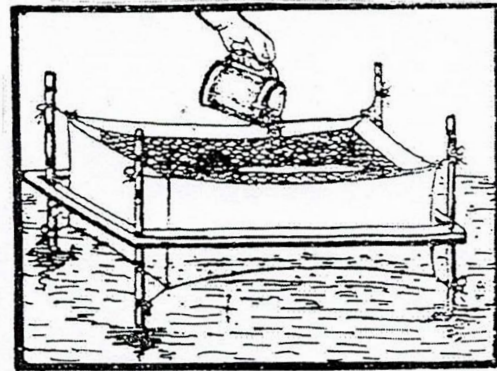
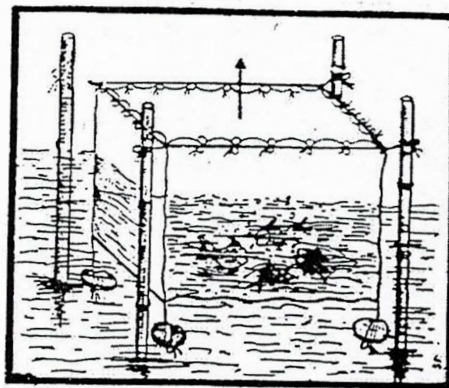
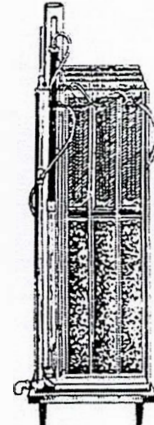

(f)

**Plate 3.2.** (a) Funnel hatchery  
(b) Low cost hatchery.  
(c) Mini hatchery

(d) Jugar bottle hatchery  
(e) Bearable hatchery  
(f) Hapa hatchery.



### 3.1.4 Requirements for a fish hatchery

Proper site selection plays an important role in any successful fish hatchery. The vital requirements of a fish hatchery include-

- i. Adequate supply of quality water.
- ii. Sufficient land for hatchery tanks, buildings and other assets.
- iii. Electricity.
- iv. Transportation facilities; and
- v. Manpower.

In addition, the following factors need to be considered on the site.

**A. Ecological factors:** These factors consider the relationship between the abiotic and biotic factors existing in the site. Such as-

- i. **Water supply:** There must be a reliable source of water, which needs proper analysis for discharge, yield, flood and elevations. Sources of water supply for hatchery include rivers, reservoirs, spring, beels, lakes and bore holes and deep wells. It is essential that water for hatchery should be free from pollution.
- ii. **Temperature:** Most warm water fishes need water temperature ranging from 20°C to 30°C for their propagation. Extreme cold or warm temperature inhibit final gonad development.
- iii. **Physical properties:** Emphasis should be given to maintain the standard level of turbidity, transparency and odor. Therefore, the water must be analyzed.
- iv. **Chemical properties:** pH (Potenz Hydrogen), dissolved oxygen, free carbon-di-oxide, salinity and ammonia at what level these are useful or toxic should be considered. The extent of pollutants from agricultural or industrial origin should be investigated.
- v. **Biological properties:** Quantity and density of plankton, species and type of parasites should be investigated.

**B. Economic and social factors:** This involves the cost involved and reactions of people in the area of operation. It includes-

- i. Ownership, availability of land and cost of land.
- ii. Availability of equipment and construction materials.
- iii. Availability of supplementary feeds.
- iv. Location of markets for the produce and determination of demand.
- v. Cost of equipment, materials and feeds.
- vi. Availability of suitable transport facilities.
- vii. Availability of staff with adequate hatchery management skills.
- viii. Information on local financing methods or credits.
- ix. Political realities.

**C. Biological and operational factors:** These include-

- i. Selection of species to be cultured.
- ii. Resources and availability of brood stock.
- iii. Operational target.
- iv. Estimated size of area required.

### **3.1.5 Hatchery Construction**

A modern hatchery or a fish seed multiplication farm is composed of four different units.

- i. Brood fish pond,
- ii. The hatchery,
- iii. Nursery; and
- iv. Fingerling rearing cum production ponds.

#### **i. Brood fish pond**

The brood fish provides several products for starting new generations of fish. It must be given adequate care. Smaller ponds are recommended for the harvesting and selection of brooders. Pond size ranging from 200-1000 m<sup>2</sup> is adequate. Let the number, size and variety of species of brooders guide the pond size.

Brood fish ponds should be a minimum of five meters deep and be supplied with sufficient water. Replenish the water lost by evaporation or leakage carefully. Store brood fish in an area with adequate security and easily accessible. Rectangular shaped ponds of  $(75 \times 20) \text{ m}^2$  or  $(80 \times 25) \text{ m}^2$  are adequate.

## **ii. Hatchery**

The hatchery is very important and needs water with good quality during the propagation season. Spent water from the hatchery can be diverted into other units. The hatchery includes tanks or containers where ripe brooders for inducing breeding are kept. These are fish breeding tanks. The bottom of these tanks has a gentle slope towards the drain. They can be completely and drained easily. The recommended sizes of fish breeding tanks are  $(2.5 \times 1.5 \times 1.0) \text{ m}^3$  for 4-10 breeders and  $(4 \times 2 \times 1) \text{ m}^3$  for more.

Another type of breeding tank named circular tank is essential part of hatchery. This breeding tank is mainly used for spawning of the brood fishes. It has a slopping bottom leading to outlet and can be completely drained out when required. With a measurement of 3.5 m in diameter and 1.5 m in depth is better for circular breeding tank. The average water holding capacity of this type of circular tank may be about 3000 litres.

For incubation of fertilized eggs funnel type or conical shape hatching jar or bottle is essential. Diameter of each hatching jar about 0.8 m and 1.2 m in depth having a water capacity of 320 litre is preferable. Each hatching jar contains an inlet of bottom and an outlet at the top. The outlet of hatching jars is provided with fine nylon cloth and the top is also covered with fine meshed net to prevent the eggs from escaping.

Concrete overhead tank is another important part of a hatchery. The materials required for the construction of concrete tanks are sand, chipping stone, cement, re-enforcement rods, binding wire, nails, wood and plumbing materials. The wood and plumbing materials are for the inlets and outlets of the tanks.

Normally the shape of overhead tank is rectangular and it is better to construct the overhead tank with the measurement of 80×6.0×2.5m. The tanks are plastered inside. Plastering provides smooth surface. The right-angled joints are 'rounded off'. This makes easy cleaning and reduced algal, bacterial and protozoan growth. It is the main reservoir for water used for hatching purposes. All tanks require a good drainage. A turn down pipe requires a gentle slope on the floor towards drainage.

### **iii. Nursery, rearing and production ponds**

The number of nursery, rearing and production ponds for a hatchery depend on the number of fry and fingerlings expected from the hatchery. The sizes depend on the following factors:

- Species to be bred
- Fecundity of the species
- Number of brooders
- Number of hatchable eggs
- Number of surviving fry to fingerlings

Nursery ponds may range from 200-500 m<sup>2</sup>, while rearing and production ponds should range from 500-2000 m<sup>2</sup>. The management of these ponds depends on the ability of the fish culturist. They could be rectangular in shape, but better when the width is half the length. This facilitates easy seining during partial harvesting. Proper drainage system in these ponds is necessary. The bottom measures 2.0-2.5 m from either side towards the middle measuring 2-3 m. A wide ditch of 0.5m deeper than the flat surface of the bottom is constructed to provide refuge for the fish. The soil for these ponds should have a good percentage of clay that is water tight. The desired water levels in ponds should be maintained during rearing at any season of the year.

### **3.1.6 Present status of hatcheries and hatchlings production of Rajshahi district**

Rajshahi division consists of 8 districts and 123 Upazillas. Under the Rajshahi district there are 9 upazillas, such as Paba, Tanore, Mohonpur, Godagari, Durgapur, Charghat, Bagha, Bagmara and Puthia. In this division the number of public hatcheries are 18 and private hatcheries are 253. There are 1190 nurseries in this division (FRSS, 2011, DoF). In Rajshahi district, the number of public hatcheries are 2 and private hatcheries are 23. But now few private hatcheries are closed (Table 3.1) from field investigation. There are about 4 govt. nurseries and 828 private nurseries in this district. The annual fish spawn production from Rajshahi district by the two government hatcheries was 296.3 kg and by the private hatcheries was 10,190 kg (DoF, 2011). Beside this the 4 govt. nurseries produced 5.318 mt fingerlings and 828 private nurseries produced 550.23 mt of fingerlings also (FRSS, 2010, DoF).

Rajshahi is one of the richest districts of Bangladesh in respect of its vast, diverse and unique fisheries resources. Total pond area of Rajshahi district is 7729 ha which is 2.53% of total pond area of Bangladesh (305,025 ha). But total fish production from ponds of Rajshahi district in 2008-2009 was 28046 mt which is 3.07% of total fish production from ponds production (912178 mt) of Bangladesh in 2008-2009 (FRSS, 2010, DoF).

The open water fish production of Rajshahi district was 15,838 mt in 2008-2009 and it was 1.41% of total open water fish production (11,23,925 mt) of Bangladesh in 2008-2009 (FRSS, 2010, DoF).

Nowadays due to degradation of ecological balance, man-made and natural obstacles the natural resources of fry are destroyed. So, hatchery is the most important source of fry production.

**Table 3.1.** Name of the hatcheries under the Rajshahi District.

Sl.	Name of the hatchery	Name of the owner	Category	Location: Thana/ Upazilla
1.	Rajshahi Sadar Fish Seed Multiplication Farm, Bornali, Rajshahi	Government	Public	RCC*
2.	Arif Matsha Hatchery, Court Station, Rajshahi	Md. Ariful Islam	Private	RCC*
3.	Masud Matsha Hatchery, Mianpur, Rajshahi	Md. Masud Rahman	Private	RCC*
4.	Hasibul Matsha Hatchery, Meherchandi, Rajshahi	Md. Abdul Hakim	Private	RCC*
5.	Sarker Matsha Hatchery, Rajpara, Rajshahi	Md. Mamunur Rashid	Private	RCC*
6.	Remco Hatchery and Fisheries, Shisapara, Rajshahi	Md. Jewel	Private	RCC*
7.	Al-Amin Swadeshi Matsha Hatchery, Samsadipur, Rajshahi	Md. Monzur Rahman	Private	RCC*
8.	Janata Matsha Hatchery, Bajubagha, Rajshahi	Md. Alauddin	Private	Bagha
9.	Sheba Agro Co. Ltd., Tapukaria, Rajshahi	Al-Haz Md. Alauddin	Private	Bagha
10.	Bani Matsha Hatchery, Mochmail, Rajshahi	Sri Jitendranath Manik	Private	Bagmara
11.	Manika Matsha Hatchery, Taherpur, Rajshahi	Khandoker Tauhidul Karim Mukul	Private	Bagmara
12.	Bhai Bhai Matsha Hatchery, Ramrama, Rajshahi	Md. Shorat Ali	Private	Bagmara
13.	Bablu Matsha Hatchery, Durgapur, Rajshahi	Md. Akbar Hossain Bablu	Private	Durgapur
14.	Rony and Sujan Matsha Hatchery, Palibazar, Rajshahi	Md. Ibne Salam	Private	Durgapur
15.	Bakim & Hannan Matsha Hatchery, Mougachi, Rajshahi	Md. Hannan and Abdul Bakim	Private	Mohonpur
16.	Sarker Matsha Hatchery, Mougachi, Rajshahi	Md. Abdul Aziz Sarker	Private	Mohonpur
17.	Faisal Matsha Hatchery, Mougachi, Rajshahi	Abdul Wahab Mondal	Private	Mohonpur
18.	Dui Bhai Sonali Matsha Hatchery, Kamarpara, Rajshahi	Md. Saber Ali	Private	Mohonpur
19.	Delowar Matsha Hatchery, Fulshow, Rajshahi	Md. Dulal Hossain	Private	Mohonpur
20.	Satata Matsha Hatchery, Fulshow, Rajshahi	Md. Rabiul Islam Robi	Private	Mohonpur
21.	Dui Bhai Sonali Matsha Hatchery, Fulshow, Rajshahi	Md. Saber Ali	Private	Mohonpur
22.	Puthia Fish Seed Multiplication Farm, Puthia, Rajshahi	Government	Public	Puthia
23.	Shuvo Irin Matsha Hatchery, Tabaria, Taherpur, Rajshahi	Md. Arifuzzaman	Private	Puthia
24.	Atique Matsha Hatchery, Puthia, Rajshahi	Md. Atiqur Rahman	Private	Puthia
25.	Al-Mofa Fish Private Limited, Chanduria, Rajshahi	Al-Haz Md. Osman Gani	Private	Tanore

\* Rajshahi City Corporation

### **3.2 Materials and Methods**

The credibility of the result of a scientific research depends to a great extent on the appropriate methodology used in the research. Improper methodology very often leads to erroneous result. So, great care was taken in following a scientific and logical methodology for carrying out this research. The research methodology was followed to achieve the objectives of the study and the choice for selecting research tools and the methods for data collection. It also deals with the selection of analytical methods that have been used in the study. The study was survey based, survey method was used to collect data. A questionnaire was made and it is shown in Appendix Table 1.

#### **3.2.1 Selection of the study area**

Selection of the study area is an important step for hatchery management study. The selection of an area for the investigation depends on the objective or purpose set for the study. The area in which a farm business survey is to be carried out depends on the particular purpose of the survey and possible cooperation. The information was collected for the fulfilment of the objectives of the study. On the basis of this view Rajshahi district was selected for this purpose. Primary information about the location of private fish seed farms was collected from district fishery office. Finally data were collected from 18 hatchery owners/managers (Table 3.2). This district (Rajshahi) was selected due to the following reasons:

- i. Number of freshwater fish hatcheries are comparatively higher in this district.
- ii. There are many successful private carp fish farmers in this area.
- iii. By studying this district we can estimate the overall fish farming status in the northern region of Bangladesh.
- iv. There were good communication facilities from the hatcheries to different localities of Rajshahi and to the other districts of Rajshahi.
- v. The study area was not far away and thus it was less expensive as well as easier for data collection.
- vi. The area was accessible as well as technically acceptable for any researcher.

**Table 3.2.** Name of the surveyed hatcheries under the Rajshahi District.

Sl.	Name of the hatchery	Name of the owner	Category	Location: Thana/ Upazilla
1.	Rajshahi Sadar Fish Seed Multiplication Farm, Bornali, Rajshahi	Government	Public	RCC*
2.	Arif Matsha Hatchery, Court Station, Rajshahi	Md. Ariful Islam	Private	RCC*
3.	Masud Matsha Hatchery, Mianpur, Rajshahi	Md. Masud Rahman	Private	RCC*
4.	Hasibul Matsha Hatchery, Meherchandi, Rajshahi	Md. Abdul Hakim	Private	RCC*
5.	Sarker Matsha Hatchery, Rajpara, Rajshahi	Md. Mamunur Rashid	Private	RCC*
6.	Sarker Matsha Hatchery, Mougachi, Rajshahi	Md. Abdul Aziz Sarker	Private	Mohonpur
7.	Faisal Matsha Hatchery, Mougachi, Rajshahi	Abdul Wahab Mondal	Private	Mohonpur
8.	Dui Bhai Sonalli Matsha Hatchery, Fulshow, Rajshahi	Md. Saber Ali	Private	Mohonpur
9.	Delowar Matsha Hatchery, Fulshow, Rajshahi	Md. Dulal Hossain	Private	Mohonpur
10.	Satata Matsha Hatchery, Fulshow, Rajshahi	Md. Rabiul Islam Robi	Private	Mohonpur
11.	Dui Bhai Sonali Matsha Hatchery, Kamarpara, Rajshahi	Md. Saber Ali	Private	Mohonpur
12.	Puthia Fish Seed Multiplication Farm, Puthia, Rajshahi	Government	Public	Puthia
13.	Bablu Matsha Hatchery, Durgapur, Rajshahi	Md. Akbar Hossain Bablu	Private	Durgapur
14.	Rony and Sujan Matsha Hatchery, Palibazar, Rajshahi	Md. Ibne Salam	Private	Durgapur
15.	Shuvo Irin Matsha Hatchery, Tabaria, Taherpur, Rajshahi	Md. Arifuzzaman	Private	Puthia
16.	Bani Matsha Hatchery, Mochmail, Rajshahi	Sri Jitendranath Manik	Private	Bagmara
17.	Manika Matsha Hatchery, Taherpur, Rajshahi	Khandoker Tauhidul Karim Mukul	Private	Bagmara
18.	Bhai Bhai Matsha Hatchery, Ramrama, Rajshahi	Md. Shorat Ali	Private	Bagmara

\* Rajshahi City Corporation



### 3.2.2 Location of the study area

Rajshahi district consists of 9 upazillas, such as Paba, Godagari, Tanore, Mohonpur, Bagmara, Puthia, Durgapur, Charghat and Bagha. The study covers seven upazillas of Rajshahi district which are Paba, Puthia, Durgapur, Mohonpur, Bangmara, Bagha and Tanore. Some hatcheries are also located under the Rajshahi City Corporation area and different thanas of Rajshahi district other than the above seven upazillas. The study areas are shown in the location map (Collected from CDMP and Banglapedia).

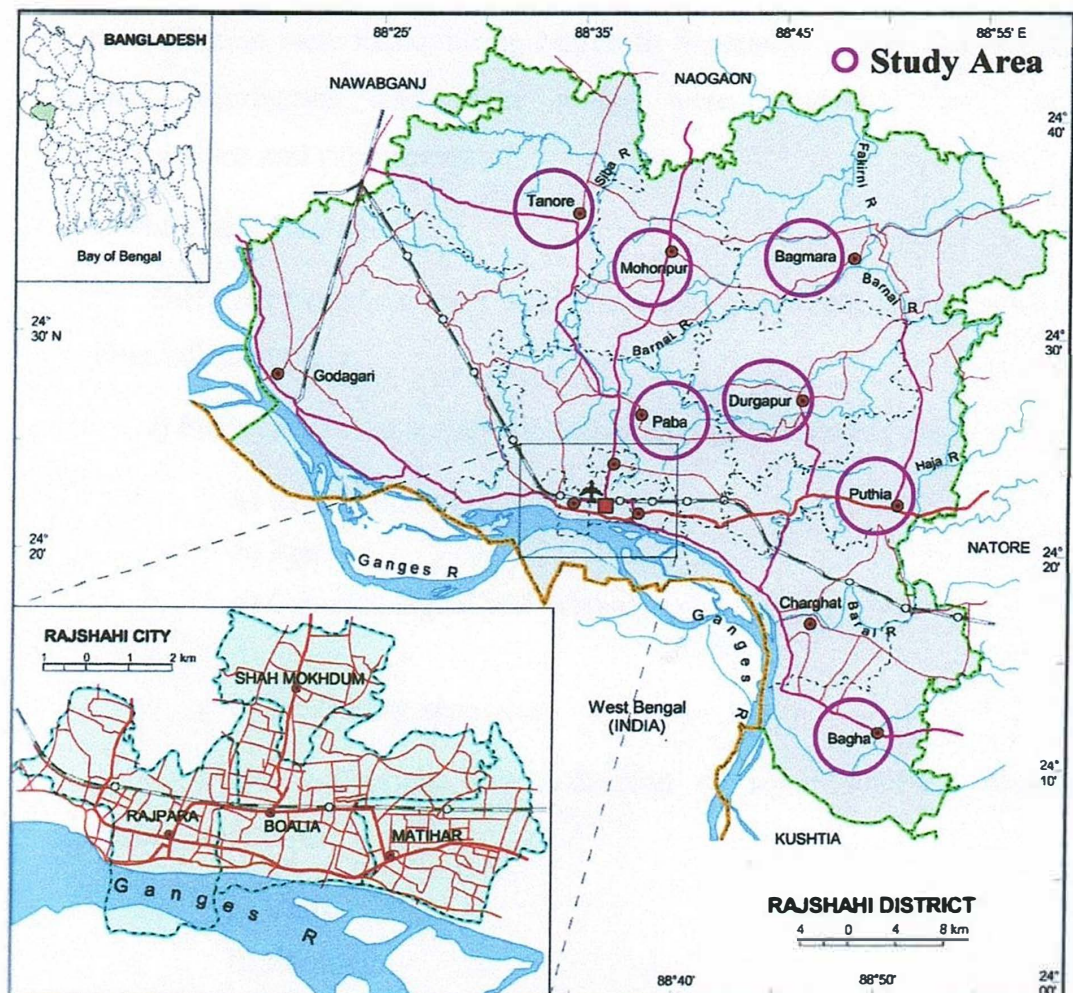

Fig. 3.1. Map of Rajshahi district showing the study areas.

### **3.2.3 Period of study**

Production season of fish seeds generally starts from March and end up by September every year. However, the survey for collection of data was conducted during January to December of 2010 and 2011, because common carp breeds also in winter season. Maximum data collection were made for 2 years during March to September of 2010 and 2011.

### **3.2.4 Preparation of survey schedule**

In order to collect relevant information interview schedule was carefully designed keeping the objectives of the study in view. Before preparing the final schedule a draft schedule was prepared in accordance with the objectives of the study. Then the draft schedule was pre-tested with a few samples. In this pretesting much attention was given to any new information and filled in the draft schedule. Thus some parts of the draft schedule were improved, rearranged and modified in the actual and practical experiences gained from the pretesting. Finally set of items were listed and grouped in the logical sequence, so that the concern authority could answer easily. The final schedule included questions on the socio-economic characteristics, physical facilities that were available in the farm, cost of producing seeds, income from the sale of spawn, fry and fingerlings and other relevant aspects of fish seed production farms.

### **3.2.5 Materials required**

Different materials were used while using different techniques to collect information.

i. Survey: For survey the following materials were used -

- a. Record book.
- b. Pen and pencil.
- c. Camera (digital and normal).
- d. Scale; and
- e. Measuring apparatus.

- ii. Collection: For collection of some samples, these materials were used –
  - a. Vials.
  - b. Formalin and
  - c. 70% Alcohol.
- iii. Interview: For interview the following materials were used –
  - a. Record book.
  - b. Pen/pencil.

Besides these materials, some other materials and instruments were also used for the study purposes which were –

- a. pH meter.
- b. Thermometer and
- c. Weight machine.

### **3.2.6 Collection of data**

It was not possible to include all the hatcheries under the study because of limitation of time and resources. Out of 23 private hatcheries and 2 public hatcheries, 18 hatcheries including 2 public hatcheries were observed. Data were collected by direct interviews from the respondents of those hatcheries with a set of previously prepared interview schedule designed for this survey. Each respondent was given a brief introduction about the nature and purpose of the study during the interview. The interview was held individually in the farm of the respective respondents during their leisure period. Questions were asked systematically in a very simple manner with explanation where ever it was felt necessary and the information recorded. A detailed interview format is shown in Appendix Table 1.

### **3.2.7 Processing and analysis of data**

After the phase of data collection, the collected data were summarized, tabulated and analyzed in accordance with the objectives of the study. A tabular method of analysis was carried out which includes classification of data in the form of tables. It is generally used to find out the crude association or differences between two sets of variables. This technique is based on arithmetic mean, percentage, ratio etc. Finally recommendation and conclusion was made on the total obtained results.

### 3.3 Results and observations

#### 3.3.1 Establishment of the hatcheries

The establishment year of the surveyed hatcheries is in between 1981-1985 to 2006-2010. The maximum hatcheries in the surveyed areas were established in 1991-1995. Table 3.3 shows the year of establishment of the hatcheries in the studied areas. Under the surveyed area there were two govt. hatcheries which were established before 1981, one in 1962 and the other in 1973.

**Table 3.3.** Year of establishment of the hatcheries in the region under investigation.

Year of establishment	Number of hatchery	Percentage (%)
1981 – 1985	1	05.55
1986 – 1990	3	16.66
1991 – 1995	5	27.77
1996 – 2000	0	00.00
2001 – 2005	3	16.66
2006 – 2010	4	22.22

#### 3.3.2 Occupation of the hatchery owners

On the basis of occupation the hatchery owners are of two types. The first type is hatchery business only and the other type is hatchery business and others. Among the surveyed 18 hatchery owners 9 hatchery owners earn their livelihood from only hatchery business and 9 hatchery owners had other business such as govt. or NGO service, agriculture, fish farming etc.

**Table 3.4.** Occupational status of the hatchery owners of the surveyed area.

Type of occupation	Number of hatchery	Percentage (%)
Only hatchery business	9	50.00
Hatchery + service	2	11.11
Hatchery + agriculture	2	11.11
Hatchery + others	5	27.78

### 3.3.3 Educational status of the hatchery owners

The educational status of hatchery owners of the surveyed areas are presented in Fig. 3.2. Out of 18 private and government hatcheries about 16.67% and 27.78% of the hatchery owners had primary and high school education, 16.67% and 11.11% hatchery owners had SSC and HSC level education respectively. 27.78% owners had from Bachelor's to Master's level education.

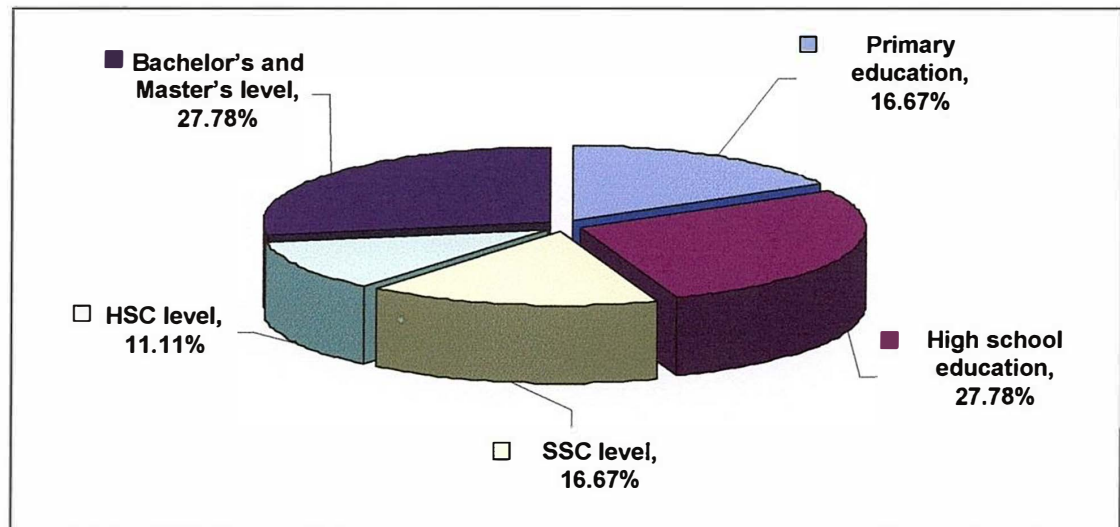

**Fig. 3.2.** Diagram showing the educational status of the hatchery owners (field investigation).

### 3.3.4 Training status of the hatchery owners

Training status of the hatchery owners are presented in the Fig. 3.3. Out of 18 hatchery owners, two (11.11%) hatchery owners had no training while sixteen (88.89%) owners received training from in country or abroad. Private hatchery owners got training from District Fishery Office or Upazila Fishery Office. At the same time the trained hatchery owners maintained a liaso with the DFO/UFO for their own interest. Two govt. hatchery managers got training from abroad and conducted different training courses for the private hatchery owners at the farm office.

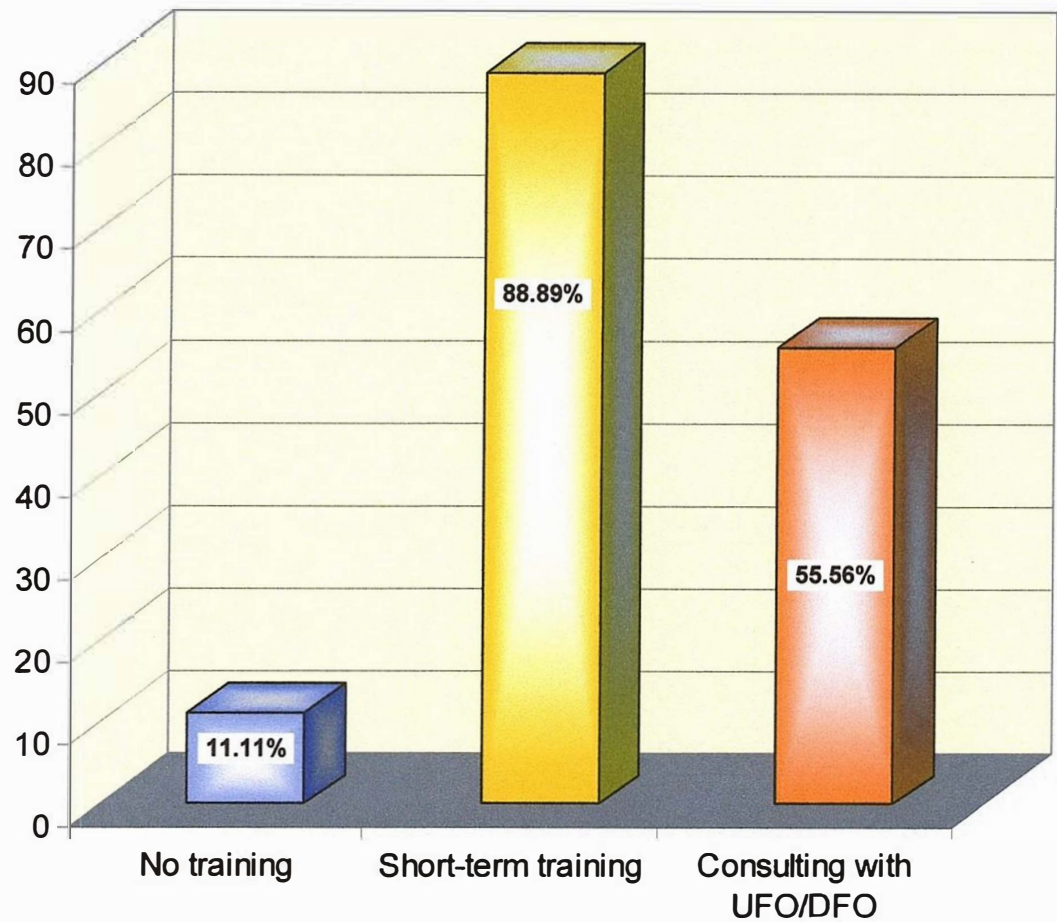

**Fig. 3.3.** Diagram showing the training status of the hatchery owners

### 3.3.5 Source of fund for hatchery operation

About 38.89% owners had funds for seed productions from their own sources. About 16.67% and 5.55% owners got their funds as loan from relatives and friends and from bank respectively. 11.11% hatchery owners received their loan from the bank only, they had no self fund, 16.67% hatchery owners received cash from money lenders (mohazon). It was observed that during investigation NGO's contribution was zero in the surveyed areas. Two govt. hatcheries were located in the surveyed area and they got all funds and expenditure from the government. Table 3.5 shows the funding source of the hatchery owners in the surveyed area.

**Table 3.5.** Funding source of the hatchery owners of the surveyed area.

Source of fund	Number of hatchery	Percentage (%)
Self	7	38.89
Self + Relatives	3	16.67
Self + Bank	1	05.55
Bank loan	2	11.11
Self + NGOs	0	00.00
Money lender (mohazon)	3	16.67
Government	2	11.11

### 3.3.6 Category of land ownership

About 55.56% owners reported that the land used for hatchery purposes was their own land and 22.22% reported both leased and own land. Only 11.11% owners reported that they operated their hatchery on the completely leased property. Fig. 3.4 shows the category of land ownership percent distribution. In the surveyed area two hatcheries were government hatcheries and their land belonged to the government property.

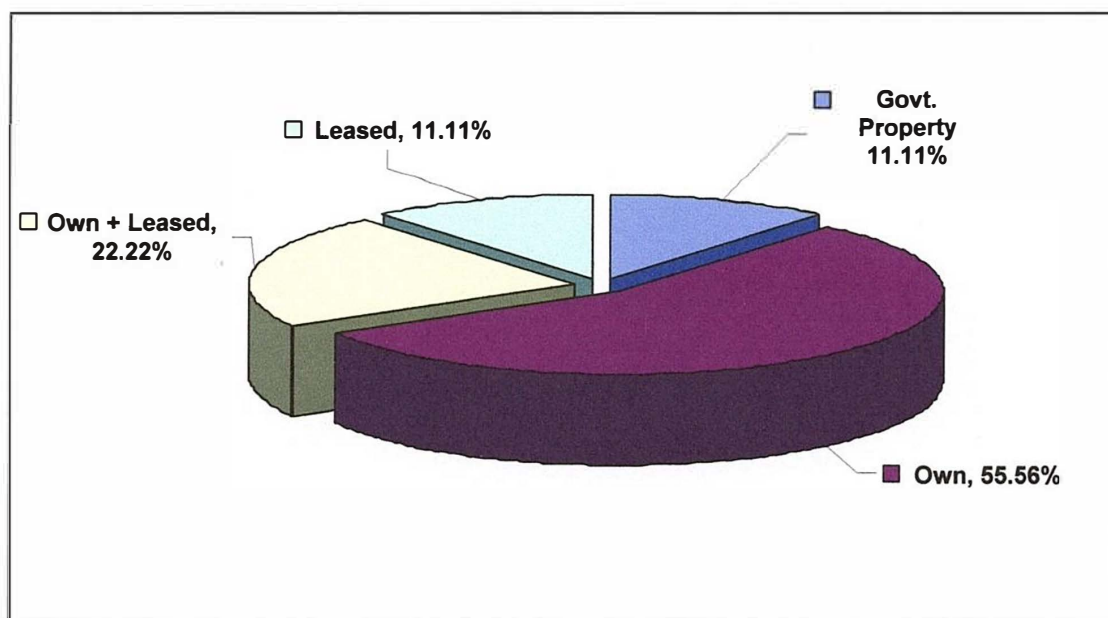

**Fig. 3.4.** Diagram showing the category of land ownership (%) of the surveyed hatcheries.

### 3.3.7 Transportation facilities

During investigation it was observed that the vehicle facilities were not well developed at all. The hatchery owners had no transportation facilities of their own. Only two public hatcheries had their own vehicles like pick-up, motorcycle, vans etc. Vans were used for caring fry in local area and pick-up used for distant place. In most cases the buyers hired mini truck or pick-up vans even manually operated vans for hatchlings transportation. Most of the hatchery owners used van, tempo and mini truck for transportation of brood fishes. The vehicles used for hatchling and brood fish transportation can be divided into two categories, i.e. mechanized such as mishuk, tempo, pick-up, mini truck, motorcycle etc. and non-mechanized such as cycle, rickshaw, van etc. Table-3.6 shows the usage of vehicles for transportation of brood fishes and spawn.

**Table 3.6.** Vehicles used for transportation of brood fishes and spawns by hatchery owners and buyers.

Name of vehicles	Number of hatcheries
<b>A. Mechanized vehicles</b>	
i. Mishuk	3
ii. Tempo	9
iii. Pick-up	4
iv. Mini truck	1
v. Motorcycle	13
<b>B Non-mechanized vehicles</b>	
i. Cycle	4
ii. Rickshaw	4
iii. Van	15

### 3.3.8 Communication facilities of hatcheries

Good communication is essential to supply spawn to the buyers in proper time. Most of the hatchery owners are satisfied about their location of the hatcheries. The communication facilities of the surveyed fish hatcheries are shown in



Table 3.7. About 27.28% owners mentioned the facility as excellent i.e. they were satisfied for existing communication facility while 55.55% and 16.67% owners mentioned the facility as good and not good respectively.

**Table 3.7.** Communication facilities of the hatcheries.

Type of communication facilities	Number of hatcheries	Percentage (%)
Excellent	5	27.78
Good	10	55.55
Not good	3	16.67

### 3.3.9 Status of employees of hatcheries

Most of the hatchery owners employed specialists called as ‘fish doctor’ in their farm. In some farms the owner himself worked as fish doctor. Both skilled and unskilled labourers were found in the surveyed hatchery. Labourers work as permanent and temporary basis. Mean monthly salary of specialist ‘fish doctors’, skilled labourers was Tk. 8941.176±2006.882, Tk. 6652.174±1256.21 and mean daily salary of unskilled labours was Tk. 156.667±12.111. Status of the staff of hatcheries is presented in Table 3.8.

**Table 3.8.** Status of staff of fish hatcheries in the surveyed area.

Type of employee	Temporary employee	Permanent employee	Mean monthly salary Tk.	Mean daily salary Tk.
Officer	-	3	21666.67±4932.883	-
Specialist	-	17	8941.176±2006.882	-
Skilled	-	24	6652.174±1256.21	-
Unskilled (labours)	06	26	4423.077±870.084	156.667±12.111

### 3.3.10 Area of hatchery

It was observed that the maximum area of the hatchery in the surveyed area was 15.0 decimal and the minimum was 3.75 decimal with an average of 8.87 decimal. Hatchery sizes of the study area are shown in Table 3.9. Table 3.9 shows the area of different hatchery in the surveyed region. There were also two government hatcheries. Due to government hatchery the area including hatchery setup are much more than other private hatchery.

**Table 3.9.** Area of hatchery in the surveyed area.

Area (decimal)	Number of hatchery	Percentage (%)
1 – 5	6	33.33
6 – 10	7	38.89
11 – 15	5	27.78

### 3.3.11 Number of ponds in the hatcheries

There are some hatcheries in the surveyed area, which not only produced fish seeds, but also reared fry or fingerling in their own ponds. Only fish seed producing hatcheries were also found in the surveyed area. Some hatchery owners only produce spawn and sell them. So they did not have nursery or rearing pond. They had only stocking pond for brood stock management. Those who produce fish seed and simultaneously rear the fingerling they had both type of ponds i.e. nursery pond and stocking pond. The maximum number of ponds was 8 and the minimum was 2. During investigation it was observed that every fish hatchery owners had their own brood stock pond. As regards to ownership it was observed that the ponds were their own or leased. Table 3.10 shows the number of nursery and brood fish ponds in the hatcheries (Plate: 3.3).

**Table 3.10.** Showing the number of ponds in the hatcheries.

Number of ponds	No. of hatcheries	Percentage (%)
2	2	11.11
3	2	11.11
4	2	11.11
5	6	33.33
6	3	16.67
7	1	05.56
8	2	11.11



(a)



(b)



(c)

**Plate 3.3.** Showing brood rearing ponds.

### 3.3.12 Physicochemical and biological characteristics of the ponds

During the study period from January to December of 2010 and 2011 the following physicochemical and biological variables of ponds such as, water temperature ( $0^{\circ}\text{C}$ ), dissolved oxygen (mg/l), hydrogen ion concentration ( $\text{pH}$ ), dissolved carbon-di-oxide (mg/l), alkalinity (mg/l) and total hardness (mg/l) were recorded and examined. A Celsius thermometer was used to record the water temperature of the hatcheries. For the measurement of  $\text{pH}$ , the  $\text{pH}$  meter ( $\text{pH}$  ep, HANNA instruments) was used. Dissolved oxygen (DO), dissolved carbon-di-oxide ( $\text{CO}_2$ ), alkalinity and total hardness of water were measured by the help of Hach's Model FF-1A Fish Farmer's Water Quality Test Kit. Table 3.11 shows the minimum, maximum and mean values of different water variables of the surveyed hatcheries.

### 3.3.13 Occurrence of fish diseases in the hatcheries:

During the survey period about 16.67% hatchery owners reported that there were no fish disease in their farms, while rest of 83.37% owners reported that there were seldom attack of fish diseases. Ulcer and fish lice disease were common as the fish disease. It was observed that the attack of fish disease did not repeat in both the years. The following Table 3.12 shows the occurrences of fish disease in the hatcheries.

**Table 3.11.** Showing the physicochemical variables of water bodies in different hatcheries during the period of 2010 and 2011.

Sl. No. of hatcheries	Year	Temperature (°C)	Dissolved oxygen (mg/l)	Hydrogen ion concentration (pH)	Dissolved carbon dioxide (mg/l)	Alkalinity (mg/l)	Total hardness (mg/l)
1.	2010	29.0	8.5	7.5	12.0	120	130
	2011	28.5	8.0	8.0	11.0	115	120
2.	2010	29.0	8.0	7.0	10.0	110	115
	2011	28.0	7.0	7.5	8.0	105	110
3.	2010	28.5	7.5	7.0	10.0	100	100
	2011	29.0	7.0	7.5	9.0	90	105
4.	2010	27.5	8.5	7.0	11.0	100	110
	2011	28.5	8.0	7.8	10.0	105	110
5.	2010	29.0	8.0	8.0	10.0	100	105
	2011	28.5	8.5	7.2	10.5	110	120
6.	2010	26.5	9.0	8.0	8.0	110	115
	2011	27.5	8.5	7.5	9.0	100	110
7.	2010	26.0	7.0	7.2	11.0	90	100
	2011	27.0	7.5	7.5	10.0	100	100
8.	2010	26.0	9.0	7.0	9.0	110	115
	2011	26.5	8.0	7.8	8.5	100	110
9	2010	27.0	8.0	7.5	12.0	95	100
	2011	26.0	8.5	7.0	10.5	100	110
10	2010	27.5	7.5	7.5	9.0	95	105
	2011	27.0	8.0	7.0	10.0	90	110
11	2010	26.5	9.0	7.5	10.0	100	110
	2011	27.0	8.5	7.0	11.0	105	115
12.	2010	26.0	9.0	7.0	12.0	110	100
	2011	27.0	9.0	7.5	11.0	105	110
13.	2010	28.5	7.0	7.5	9.0	95	110
	2011	28.0	8.0	8.0	10.0	95	115
14.	2010	29.0	8.0	7.0	10.0	100	110
	2011	28.0	7.5	7.5	12.0	105	120
15.	2010	28.0	7.5	7.5	10.0	110	120
	2011	27.0	7.0	8.0	9.0	115	125
16.	2010	28.0	8.5	7.0	9.0	100	110
	2011	27.0	8.0	7.5	8.0	105	105
17.	2010	27.5	7.5	7.0	12.0	110	120
	2011	28.0	7.0	8.0	10.0	100	110
18.	2010	29.0	6.5	7.0	11.0	105	110
	2011	27.5	7.0	8.0	10.0	95	100
Minimum		26.0	6.5	7.0	8.0	90	100
Maximum		29.0	9.0	8.0	12.0	120	130
Mean ± SD		27.63± 0.97	7.92± 0.70	7.43± 0.38	10.07± 1.17	102.78± 7.31	110.83± 7.42

**Table 3.12.** Occurrence of fish disease in the surveyed hatcheries.

Category of occurrence of fish disease	No. of hatcheries	Percentage of occurrence (%)
No disease	3	16.67
Seldom attack	15	83.37
Every year attack	0	00.00

### 3.3.14 Source of water supply and water discharge system

Most of the hatchery owners in the surveyed area reported that they used only underground water for hatchery purposes. But only 2 hatchery owners reported the use of mixed water of both underground and pond water. The discharge of water from the hatcheries was maintained through drain. Some hatcheries maintain a good drainage system. Rajshahi Sadar Govt. Fish Seed Multiplication Farm and Puthia Govt. Fish Seed Multiplication Farm have ground drainage system through which used water could be discharged. The following chart view shows the discharge water direction from the hatcheries.

- Underground water → overhead tank → hatchery house → pond → drain
- Underground water → overhead tank → hatchery house → pond → agricultural lands

### 3.3.15 Number and water carrying capacity of overhead tanks in the surveyed hatcheries

In most cases the overhead tanks were rectangular in shape. These were made of cement, bricks, rods, etc. and were placed over RCC pillar from the ground. Some hatchery owners have made their office room and store room under the overhead tank. It is main reservoir for water used for hatching purposes. Normally each hatchery has one overhead tank. Every hatchery has oxygen mixing system in the overhead tanks. The average number of overhead tank was  $1.00 \pm 0.00$ . The volume of overhead tanks ranged from  $13.25 \text{ m}^3$  to  $73.47 \text{ m}^3$  with an average of  $37.12 \pm 15.78 \text{ m}^3$ . The water carrying capacity of overhead tanks ranged from 13249.81 to 73474.87 litre with an average of  $37114.80 \pm 15782.35$  litre (Appendix Table 2 and Plate 3.4).



(a)



(b)



(c)

**Plate 3.4.** Showing overhead tanks of different surveyed hatcheries.

### **3.3.16 Circular breeding tanks**

Circular breeding tanks were made of bricks and cement. These tanks are used for the breeding of fishes in the hatcheries. There are sets of pipe with 45° angle for circulation of water and one pipe is set of the central point to go outside the water. Among 18 surveyed hatcheries there were 4 circular breeding tanks in 4 hatcheries. The volume of circular breeding tanks ranged from 3.270m<sup>3</sup> to 12.812m<sup>3</sup> with an average of 6.81±4.24m<sup>3</sup>. The water carrying capacity of the circular breeding tanks ranged from 3269.70 litre to 12811.90 litre with an average of 6814.66±4238.40 litre (Appendix Table 3 and Plate 3.5).

### **3.3.17 Circular hatching tanks**

The circular hatching tanks are made of bricks and cement. Its pipe setup mechanism is similar to circular breeding tanks. The number of circular hatching tanks varied in different surveyed hatcheries from 1 to 3 with an average of 2.00 ± 0.93 and volume varied 3.270 m<sup>3</sup> to 11.210 m<sup>3</sup> with an average of 6.91 ± 3.22 m<sup>3</sup>. The water carrying capacity of circular hatching tanks in the surveyed area ranged from 3269.70 litre to 11210.410 litre with an average of 6899.34 ± 3201.80 litre (Appendix Table 4).

### **3.3.18 Houses or cisterns**

Rectangular houses or cisterns were made of bricks and cement. The number of houses ranged from 3 to 13 with an average of 6.44 ± 2.55. The maximum volume of each house was 4.06 m<sup>3</sup> and the minimum was 1.73 m<sup>3</sup> with an average of 3.13 ± 0.57 m<sup>3</sup>. The total volume of the houses ranged from 10.14 m<sup>3</sup> to 43.94 m<sup>3</sup> with an average of 20.15 ± 9.27 m<sup>3</sup>. The total water carrying capacity of the houses in the surveyed hatcheries ranged from 10125.03 litre to 43940.00 litre with an average of 20139.80 ± 9265.87. The house or cistern was used for brood fish conditioning and rearing of fry with the help of hapa (Appendix Table 5 and Plate 3.6).



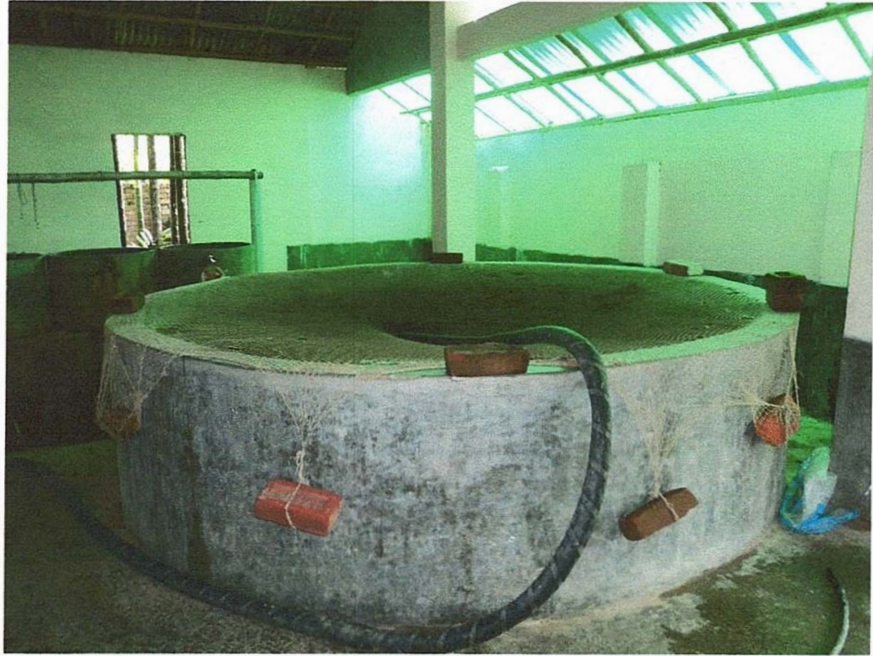

(a)



(b)

**Plate 3.5.** Showing circular breeding tanks of the surveyed hatcheries.



(a)



(b)

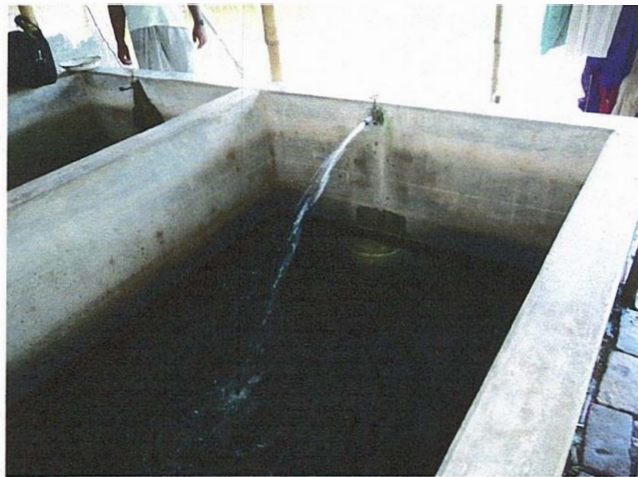

(c)

**Plate 3.6.** Showing houses / cisterns of different surveyed hatcheries.

### 3.3.19 Jar or Bottles

Funnel shaped bottles or jars are very necessary in the fish hatchery for hatching the eggs. Mainly these were made of cement, steel sheet made bottles were also found in the surveyed hatcheries. The number of jars ranged from 4 to 19 with an average of  $10.50 \pm 3.17$ . The total volume of bottle ranged from  $1.292 \text{ m}^3$  to  $8.056 \text{ m}^3$  with an average of  $5.21 \pm 1.69 \text{ m}^3$ . The total water carrying capacity of jars ranged from 1291.72 to 8053.15 litres with an average of  $5208.43 \pm 1685.25$  litre (Appendix Table 6 and Plate 3.7).



(a)



(b)



(c)

**Plate 3.7.** Showing jar/bottles of different surveyed hatcheries.

### 3.3.20 Chemicals used for washing tanks, houses and bottles

To get good production, cleaning is an important factor in the hatchery management. During investigation it was found that chemicals and medicines used in hatchery activities in the surveyed area were more or less similar. Different chemicals were used to clean or hygiene the overhead tanks, breeding tanks, hatching tanks, bottles/jars and houses/cisterns before starting and thereafter. Normally potash, bleaching powder, detergent powder, formalin, copper sulphate, methyl blue, lime etc. were used for this purpose. Some hatchery owners washed the tanks and bottles when they faced problems like sudden high mortality of fry. Some owners washed different tanks weekly. Normally they washed two times in a month. All of them washed the bottles/jars regularly after every hatching (Fig. 3.5)

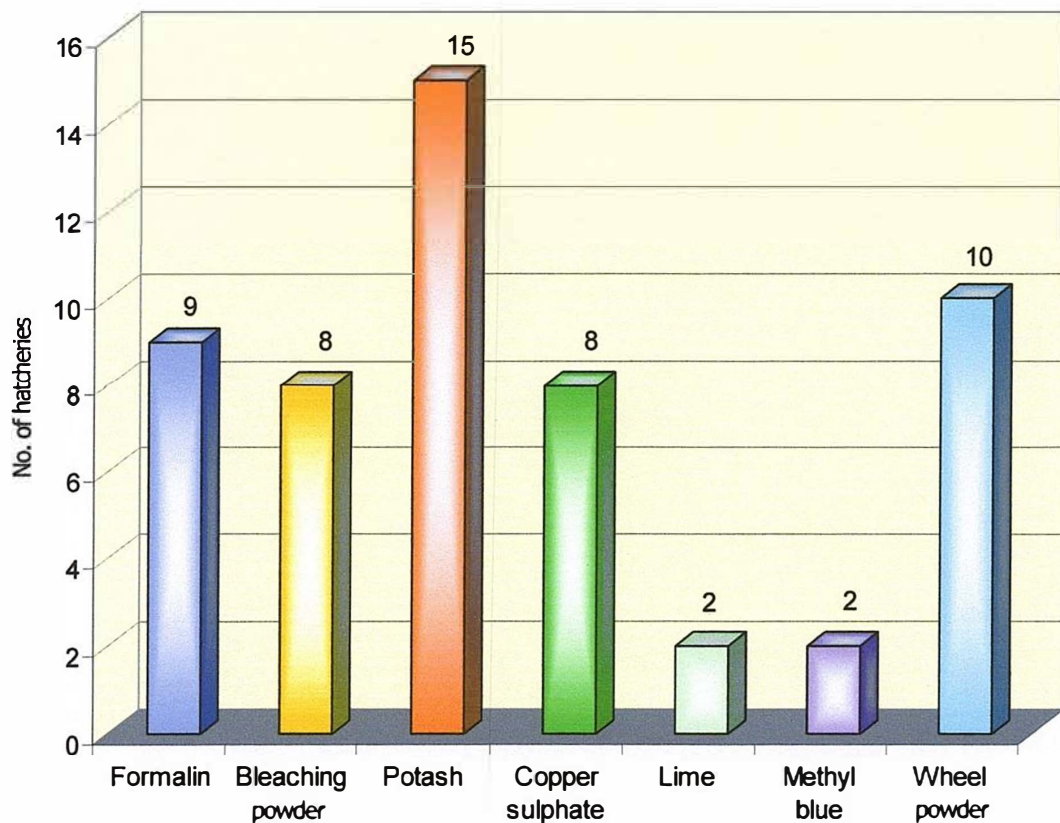

**Fig. 3.5.** Diagram showing the chemicals used for washing tanks, houses and bottles.

### 3.3.21 Source of brood fishes

Brood fishes are the key element of a hatchery. In the surveyed area most of the hatcheries has the provision of stocking the brood fishes. For this purpose separate stocking ponds are present in the hatcheries. The number of brood fish ponds vary from 2 to 4. Area of the ponds ranged from 0.5 to 1.75 hectares. Besides this some hatchery owners collected brood fishes from various sources like rivers, own ponds, other ponds, local markets, brood banks etc. Young broods were purchased from local area or market. The broods were reared with special care for better hatching purposes. Collection source of brood fishes are shown in Fig. 3.6.

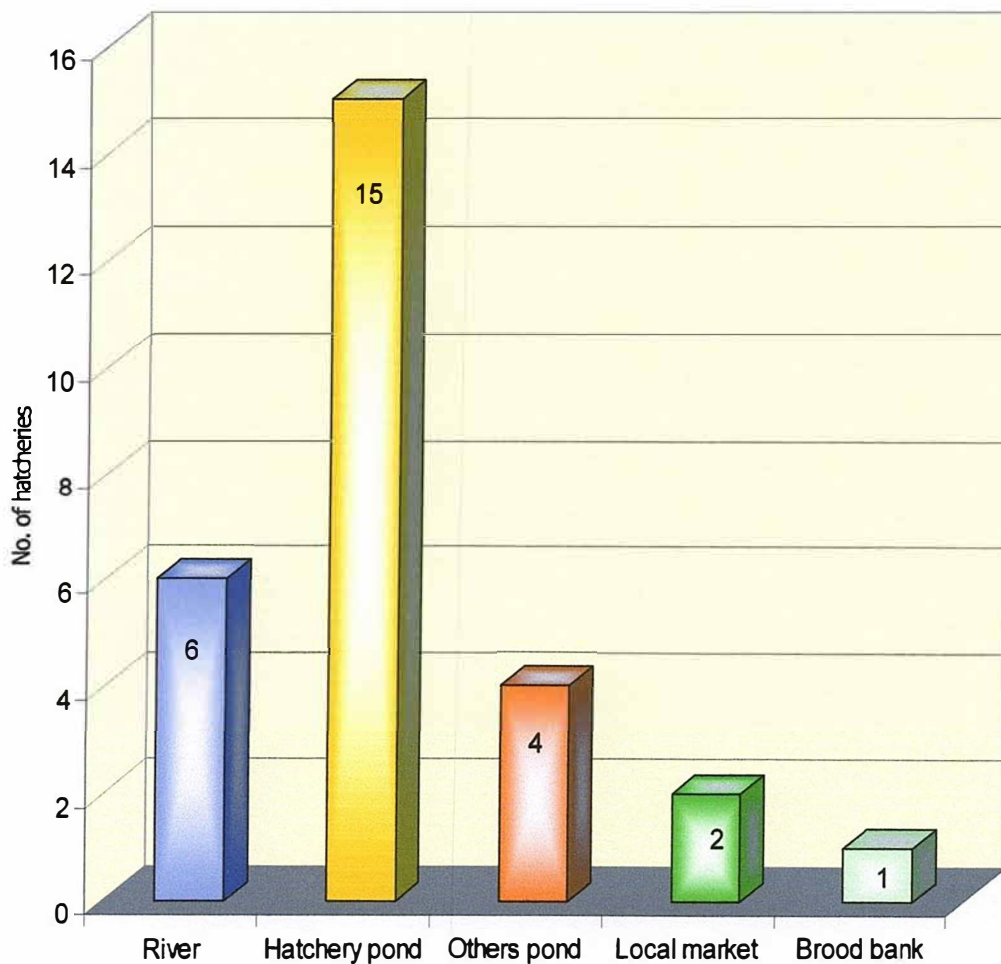

**Fig. 3.6.** Diagram showing the source of brood fishes.

### 3.3.22 Brood fish stocking and rearing

A hatchery must have healthy and fresh brood fish to produce healthy hatchlings fry. So, they have the provision of stocking the brood fishes in own care. For this purpose separate brood fish stocking and rearing ponds were present in the hatcheries. The hatchery owners strictly followed some measures for good brood fish management, such as regularly weed clearance from brood stocking ponds, removal of predatory and unexpected wild fishes, a certain level of water maintenance, pond fertilization, application of supplementary feeds, fish health care and monitoring of pond environment etc. The broods were reared with special care. Before the release of the broods, ponds were well prepared. Generally 10 species of brood fishes were used in the surveyed hatcheries for the induced breeding. Among them 5 fish species were native and 5 were exotic. Most of the hatchery owners produced normally carp fish fry. The brood fishes and their scientific name are shown below (Table 3.13).

**Table 3.13.** The brood fishes and their scientific name used for spawning purposes.

No.	Type	Common name	Scientific Name
1.	Native species	Rui	<i>Labeo rohita</i>
2.		Catla	<i>Catla catla</i>
3.		Mrigel	<i>Cirrhina mrigala</i>
4.		Calibaush	<i>Labeo calbasu</i>
5.		Bata	<i>Labeo bata</i>
6.	Exotic species	Silver carp	<i>Hypophthalmichthys molitrix</i>
7.		Bighead carp	<i>Aristichthys nobilis</i>
8.		Grass carp	<i>Ctenopharyngodon idella</i>
9.		Common carp	<i>Cyprinus carpio</i>
10.		Raj puti	<i>Puntius gonionotus</i>

### 3.3.23 Stocking density of brood fishes

During the investigation it was found that a total of 10 species of fishes were stocked in the stocking ponds in these hatcheries. The stocking density of brood fishes were found different in the surveyed hatcheries. The stocking density of brood fishes is shown in the Table 3.14.

**Table 3.14.** The stocking density of different species of brood fishes.

Sl.	Name of brood fishes	Minimum (%)	Maximum (%)	Mean
1.	Rui	25	35	27.67±3.03
2.	Catla	8	20	14.17±3.75
3.	Mrigel	5	15	10.06±3.35
4.	Silver carp	14	25	16.17±2.75
5.	Punti	5	10	6.38±2.07
6.	Calibaush	4	5	4.40±0.50
7.	Grass carp	5	10	6.23±1.72
8.	Common carp	5	15	09.44±2.31
9.	Bighead carp	5	8	5.75±1.73
10.	Bata	8	25	12.67±3.87

**Rui:** The stocking density of rui released in the stocking ponds of 18 hatcheries ranged from 25% to 35% with an average of 27.67±3.03.

**Catla:** Among the 18 surveyed hatcheries the stocking density of Catla reared in these ponds was in between 8% to 20% with an average of 14.17±3.75.

**Mrigel:** The stocking density of mrigel ranged from 5% to 15% in these hatcheries with an average of 10.06±3.35.

**Silver carp:** In the surveyed hatcheries the stocking density of silver carp stocked in the ponds was in between 14% to 25% with an average of 16.17±2.75.



**Punti:** The stocking density of Punti reared in these surveyed hatcheries ranged from 5% to 10% with an average of  $6.38 \pm 2.07$ .

**Calibaush:** Among 18 surveyed hatcheries it was found that only 5 hatcheries reared Calbasu as brood fish. The stocking density of Calbasu ranged from 4%-5% with an average of  $4.40 \pm 0.50$ .

**Grass carp:** The stocking density of grass carp was in between 5% to 10% with an average of  $6.23 \pm 1.72$  in these surveyed hatcheries.

**Common carp:** It was found that all the 18 surveyed hatcheries released Common carp in the ponds at the stocking density of 5% to 15% with an average of  $09.44 \pm 2.31$ .

**Bighead carp:** Among 18 surveyed hatcheries only 4 hatcheries released Bighead carp in their ponds as brood fish. The stocking density of bighead carp was found 5% to 8% with an average of  $5.75 \pm 1.73$ .

**Bata:** The stocking density of Bata reared in the brood ponds ranged from 8% to 25% with an average of  $12.67 \pm 3.87$ .

### **3.3.24 Supplementary feeds used for brood fishes**

To get better seed production and better growth of brood fishes, the special care was taken for the brood fishes by the hatchery owners. In this purpose the hatchery owners used supplementary feeds regularly at the rate of 2 to 3 percent of total body weight of brood fishes in the everyday morning and evening. As supplementary feeds the hatchery owners used oil cake, rice bran, boiled rice, wheat bran, molasses, flour, fish meal etc. For better growth the feed gradients are mixtured and made balls and pellets by pelletizer machine and supplied to the fishes. The name and percentage of used supplementary feeds are shown in the following Table 3.15. The supplementary feed preparation and two types of supplementary feeds used are shown in Plate 3.8 and Plate 3.9.

**i. Oil cake:** Supplementary feeding with oil cake used in the surveyed hatcheries ranged from 15% to 35% with an average of  $22.222\pm 4.278$ .

**ii. Rice bran:** Supplementary feeding with rice bran used in the surveyed hatcheries ranged from 15% to 40% with an average of  $21.389\pm 5.637$ .

**iii. Boiled rice:** Boiled rice was used as a supplementary feed in the surveyed hatcheries which ranged from 12% to 20% with an average of  $17.00\pm 3.464$ .

**iv. Wheat bran:** Wheat bran was used as a supplementary feed in the surveyed hatcheries which ranged from 10% to 20% with an average of  $16.125\pm 3.304$ .

**v. Blood wastage:** Supplementary feeding with blood wastage used in the surveyed hatcheries ranged from 10% to 15% with an average of  $11.75\pm 3.363$ .

**vi. Flour:** Supplementary feeding with flour used in the different hatcheries ranged from 10% to 20% with an average of  $14.143\pm 3.085$ .

**vii. Fish meal:** Fish meal was used as a supplementary feed in the surveyed hatcheries ranging from 15% to 45% with an average of  $22.778\pm 6.468$ .

**Table 3.15.** Different types of supplementary feeds used in the surveyed hatcheries.

Sl.	Name of feeds	Minimum (%)	Maximum (%)	Mean
1.	Oil cake	15	35	$22.222\pm 4.28$
2.	Rice bran	15	40	$21.389\pm 5.637$
3.	Boiled rice	12	20	$17.00\pm 3.464$
4.	Wheat bran	10	20	$16.125\pm 3.304$
5.	Flour	10	20	$14.143\pm 3.085$
6.	Blood wastage	10	15	$11.750\pm 3.363$
7.	Fish meal	15	45	$22.778\pm 6.468$



**Plate 3.8.** Preparation of supplementary feeds for brood fishes.



(a)



(b)

**Plate 3.9.** Supplementary feeds used in the hatcheries.

(a) Balls

(b) Pellets

### 3.3.25 Fertilizers used for stocked fishes in the stocking ponds

Most of the hatchery owners used fertilizers in their brood fish stocking ponds to grow the natural food. Natural food in the ponds are needed for well growth of brood fishes. They used cow dung, poultry wastes as organic fertilizers and urea, TSP, MoP were used as inorganic fertilizers. The fertilizers were applied in the brood fish ponds weekly or fortnightly at the rate of DoF recommendation. The following Table 3.16 and Plate 3.10 shows the use of fertilizers in different hatcheries (DoF, 2000a and 2008).

**Table 3.16.** The use of fertilizers in different hatcheries

Name of fertilizer	Minimum (%)	Maximum (%)	Mean $\pm$ SD
<b>Organic</b>			
Cow dung	15	35	26.888 $\pm$ 5.717
Poultry waste	5	16	10.230 $\pm$ 4.003
<b>Inorganic</b>			
Urea	22	40	31.888 $\pm$ 4.981
TSP	18	32	22.277 $\pm$ 4.169
MoP	5	18	12.235 $\pm$ 3.649

**(a)****(b)****(c)****(d)****(e)****Plate 3.10.** Types of fertilizers used in the hatcheries-

- (a)** Cow dung;
- (b)** Poultry waste.
- (c)** Urea;
- (d)** TSP and
- (e)** MoP

### 3.3.26 Conditioning of brood fishes

Brood fishes are needed for conditioning before induced breeding. For this purpose selected brood fishes were kept in cemented cistern under continuous water flow through water exchange system. The conditioning period varied from species to species. The males and females were conditioned in separate tanks. In this way the fishes were kept to adjust themselves with new environment to increase their ability of endurance. The duration of conditioning of brood fishes varied a little among the hatcheries. The maximum conditioning time was 12 hours and minimum time was 6 hours with an average of  $9.555 \pm 2.120$ . Table 3.17 shows the duration of conditioning of brood fishes (Plate 3.11).

**Table 3.17.** Duration of conditioning of brood fishes.

Hours	No. of hatcheries	Percentage (%)
4 – 6	2	11.11
7 – 9	6	33.33
10 – 12	10	55.56



(a)



(b)

**Plate 3.11.** Showing conditioning of brood fishes.



### 3.3.27 Egg collection time from the brood fishes

During the investigation it was observed that the hatchery owners collected eggs from brood fishes only one time. But many hatchery owners responded that sometimes it might be twice or thrice during the breeding season. Table 3.18 shows the egg collection time from the brood fishes.

**Table 3.18.** Egg collection time from the brood fishes.

Collection time	No. of hatcheries	Percentage (%)
3	6	33.33
2	9	50.00
1	3	16.67

### 3.3.28 Inducing agents for induced breeding

During the investigation it was observed that the hatchery operators used mainly two types of hormones for induced breeding, such as pituitary gland extract (PG) and human chorionic gonadotropin (HCG). Pituitary gland is known as the master gland. PG or HCG hormone entered in the fish body by injection, as a result ovary and testes of brood fishes were stimulated and ready for induced breeding. From the field investigation it was observed that the farm owners used PG for rui, catla, mrigel, calibaush, bata, silver carp, common carp, grass carp, bighead carp and raj punti to induce the fishes. But they used both PG and HCG for silver carp and bighead carp to induce the fish. In this sector PG was used as a first dose and HCG was used as a second dose. The following Table 3.19 shows the usage of hormone in the fishes.

**Table 3.19.** The hormone used in different species of fishes.

Name of hormone	Name of species
i. PG (pituitary gland hormone)	Rui, Catla, Mrigel, Calbasu, Bata, Common carp, Grass carp and Raj punti
ii. PG and HCG (Human Chorionic Gonadotrophin hormone)	Silver carp and Bighead carp

### **3.3.29 Quantity of fry production**

The production capacity and annual production of 18 surveyed hatcheries under the district of Rajshahi varied due to different causes, such as stocking rate and availability of brood fishes, infrastructural facilities, water quality and environmental condition, sufficient feeds for brood fishes, efficient person and accurate dose of injection etc.

During investigation it was observed that among the 18 hatcheries 9 produced 300kg to 400kg hatchlings, 2 produced 400kg to 500kg hatchlings, 3 produced 500kg to 600kg hatchlings, 3 produced 600kg to 700kg hatchlings and only one hatchery produced 700kg to 800kg of hatchlings in both the years of 2010 and 2011 (Table 3.20). The total fry production of 18 hatcheries was 8200kg in 2010 and 8380kg in 2011.

**Table 3.20.** Quantity of annual fry production in kg in the year of 2010 (January-December) and 2011 (January-December) in Rajshahi.

Hatchery No.	Year	Rui	Mrigel	Catla	Calbasu	Bata	Punti	Silver carp	Grass carp	Common carp	Bighead carp	Total
1	2010	55	35	20	08	65	16	40	15	36	20	310
	2011	60	35	20	10	60	20	40	18	42	30	335
2	2010	105	62	45	12	140	35	78	38	125	35	675
	2011	115	68	42	10	128	40	115	32	124	18	692
3	2010	98	65	40	-	95	22	145	55	105	-	625
	2011	112	58	44	-	108	26	148	42	117	-	655
4	2010	110	60	52	-	95	18	136	34	135	-	640
	2011	125	55	48	-	104	22	148	30	133	-	665
5	2010	52	36	28	06	55	30	44	15	54	-	320
	2011	58	30	25	05	48	26	55	18	60	-	325
6	2010	62	30	26	06	48	25	45	08	48	17	315
	2011	68	32	25	05	42	28	40	10	53	25	328
7	2010	95	50	42	15	62	25	70	35	78	-	472
	2011	95	42	30	15	60	25	65	30	76	-	438
8	2010	88	46	35	-	75	35	78	32	73	-	462
	2011	110	50	42	-	70	30	85	38	70	-	495
9	2010	105	52	35	-	80	-	70	-	43	-	385
	2011	78	45	30	-	54	-	65	-	48	-	320
10	2010	65	30	24	-	48	35	56	-	57	-	315
	2011	72	36	25	-	40	44	60	-	55	-	332
11	2010	85	40	32	-	35	30	72	20	50	-	364
	2011	92	48	35	-	32	26	68	35	54	-	390
12	2010	118	62	48	-	75	-	82	52	75	-	512
	2011	122	79	40	-	80	-	108	58	78	-	565
13	2010	118	72	60	-	78	-	98	-	104	-	530
	2011	106	70	52	-	74	-	95	-	108	-	505
14	2010	65	34	25	-	48	-	56	30	52	-	310
	2011	72	35	28	-	55	-	68	35	42	-	335
15	2010	125	70	55	20	108	64	112	40	115	46	755
	2011	132	72	50	18	115	70	120	42	118	35	772
16	2010	65	60	32	-	100	-	95	75	75	-	502
	2011	82	55	35	-	94	-	105	62	95	-	528
17	2010	68	35	25	-	55	48	62	25	52	-	370
	2011	56	30	22	-	50	52	60	28	37	-	335
18	2010	65	38	24	-	56	-	62	45	48	-	338
	2011	72	45	28	-	60	-	65	42	53	-	365

### 3.3.30 Demand of hatchlings

Hatchery owners produced fish hatchlings and fry according to the need of customers' demand. During the survey period it was found that rui and silver carp were the more demandable species. Moreover, bata, common carp, mrigel, grass carp, catla, punti and bighead carps etc. were also demandable species. To the question of the demand of hatchlings maximum hatchery owners answered rui as a single species (33.33%), then followed by silver carp (27.78%), bata (22.22%), common carp (11.11%) and mrigel (5.56%).

The fish farmers and nursery owners of different parts of the country specially northern region of Bangladesh are the main customers of these hatcheries. The hatchlings are weighted on the hatchery spot and directly sold to the customers from the hatcheries. The following Table 3.21 shows the percentage of demand of different species of hatchlings produced by the hatchery owners.

**Table 3.21.** Demand of hatchlings of different species.

Sl. No.	Name of species	Percentage of demand (%)
1.	Rui	33.33
2.	Silver carp	27.78
3.	Bata	22.22
4.	Common carp	11.11
5.	Mrigel	05.56

### 3.3.31 Marketing system of hatchlings

From the investigation it was observed that most of the hatchery owners produced hatchlings and supplied those within the local area. Out of 18 observed hatcheries, 9 hatchery owners sold their hatchlings only to the fish traders and pond owners of Rajshahi district. 4 hatchery owners supplied their hatchlings to the pond owners of Rajshahi district and other districts of Rajshahi division. Only 5 hatchery owners sold their hatchlings to different district of Bangladesh including Rajshahi division. The following Table 3.22 shows the different supplied areas of hatchling distribution produced by the observed hatcheries.

**Table 3.22.** Distribution area of hatchlings produced by the hatcheries of Rajshahi.

Distributed area	No. of hatcheries	Percentage (%)
Rajshahi district	9	50.00
Rajshahi division	4	22.22
All over the country	5	27.78

### 3.3.32 Price of inputs and outputs

For good running of the hatcheries the following inputs such as organic and inorganic fertilizers, artificial feeds, labour cost, land leasing cost, fish inducing agents are necessary and the estimated cost of these inputs are also required. The cost of these inputs were estimated according to local market price. Average price of cow dung was Tk. 2.00/kg, and the prices of inorganic fertilizers such as urea, TSP and MoP were Tk. 20.00/kg, Tk. 22.00/kg and Tk. 15.00/kg respectively. Prices of artificial feeds such as rice bran, wheat bran, mustard oil cake, flour and fish meal were Tk. 15.00/kg, Tk. 20.00/kg, Tk. 22.00/kg, Tk. 22.00/kg and Tk. 24.00/kg, respectively. The cost of lime was Tk. 11.00/kg. The fish inducing hormone PG was purchased at Tk. 5.00 per piece and HCG Tk. 200.00/ample. The cost inputs of labour was Tk. 150.00/day with food and shelter for temporary basis and Tk. 4500.00/month with food and shelter for permanent. The leasing cost inputs for land and pond was Tk. 1,40,000/- to 1,75,000/- per hectare per year. Market price of various inputs are presented in Table 3.23.

**Table 3.23.** Unit price of feed, fertilizers, lime and hormone used by private fish hatcheries in the surveyed area.

<b>Kinds of item</b>	<b>Unit price (Tk./kg)</b>
<b>1. Artificial feeds:</b>	
i. Rice bran	15.00
ii. Wheat bran	20.00
iii. Oil cake	22.00
iv. Flour	22.00
v. Fish meal	24.00
<b>2. Fertilizers</b>	
i. Urea	20.00
ii. TSP	22.00
iii. MoP	15.00
iv. Cowdung	02.00
<b>3. Lime</b>	11.00
<b>4. Hormone</b>	
i. PG	05.00/piece
ii. HCG	200.00/ample

The main outputs of fish hatcheries is fish spawn. Sometimes some hatchery owners sell stocked fish to meet up the immediate cost. But main source of income of fish hatcheries is selling of fish spawn. Market price of spawn affects the gross returns from spawn production. Price of spawn depends mainly on the species of fish, time of production, availability of spawn and its demand and supply. Price of fish spawn of native species ranged from 1000 Tk./kg to 3000 Tk./kg and price of fish spawn of exotic species ranged from 800 Tk./kg to 2800 Tk/kg. The maximum and minimum prices of produced spawn have been shown in Table 3.24. Price of produced spawn was almost same among the private hatcheries of the surveyed area due to competitive market.

**Table 3.24.** Species wise maximum and minimum price of spawn in the surveyed area.

Species	Maximum price (Tk./kg)	Minimum price (Tk./kg)
Rui	3,000	1,500
Catla	3,000	1,000
Mrigel	2,500	1,500
Calbasu	2,500	1,500
Bata	2,200	1,000
Punti	1,500	800
Silver carp	2,800	1,500
Grass carp	2,500	1,000
Common carp	2,000	1,200
Bighead carp	2,500	1,500

### 3.3.33 Cost and returns of fish seed production

From the investigation it was found that fish seed production is the profitable business in the surveyed area. Cost of production, the production capacity, demand of spawn, well management system and market price of spawn were the major determining factor for net earnings in fish seed production. In 2010 the total cost involved in 18 surveyed hatcheries for the production of spawn ranged from 3.033 lakh Tk. to 8.216 lakh Tk. with an average of  $4.530 \pm 1.530$  lakh Tk., gross return ranged from 5.812 lakh Tk. to 15.574 lakh Tk. with an average of  $8.781 \pm 2.922$  lakh Tk. and net profit was in between 2.697 lakh Tk. to 7.361 lakh Tk. with an average of  $4.251 \pm 1.396$  lakh Tk. Similarly in 2011 among the surveyed hatcheries the total cost involved was in between 3.065 lakh Tk. to 7.951 lakh Tk. with an average of  $4.665 \pm 1.564$  lakh Tk. gross return in between to 5.963 lakh Tk. to 15.748 lakh Tk. with an average of  $9.127 \pm 3.099$  lakh Tk. and net profit was in between 2.928 lakh Tk. to 7.792 lakh Tk. with an average of  $4.461 \pm 1.545$  lakh Tk. Table 3.25 shows the cost and returns of fish seed production of surveyed hatcheries.

**Table 3.25.** Total cost, gross return and net return of fish seed farms in the surveyed area during the period of January, 2010 to December, 2011.

Hatcheries No.	Year	Total cost (Tk.)	Gross return (Tk.)	Net return (profit)/Tk.
1.	2010	324,000	618,500	294,500
	2011	353,550	671,800	318,250
2.	2010	685,000	1,350,000	665,000
	2011	664,320	1,370,160	705,840
3.	2010	678,125	1,287,500	609,375
	2011	738,075	1,386,525	648,450
4.	2010	617,600	1,209,600	592,000
	2011	668,325	1,316,700	648,375
5.	2010	369,600	716,800	347,200
	2011	383,500	739,375	355,875
6.	2010	313,425	622,125	308,700
	2011	339,480	664,200	324,720
7.	2010	436,600	837,800	401,200
	2011	394,200	770,880	376,680
8.	2010	482,790	935,550	452,760
	2011	537,075	1,029,600	492,525
9.	2010	371,525	721,875	350,350
	2011	312,000	604,800	292,800
10.	2010	333,900	648,900	315,000
	2011	351,920	688,900	336,980
11.	2010	362,180	713,440	351,260
	2011	399,750	791,700	391,950
12.	2010	460,800	908,800	448,000
	2011	522,625	10,25,475	502,850
13.	2010	474,350	932,800	458,450
	2011	462,075	9,14,050	451,975
14.	2010	311,550	581,250	2,69,700
	2011	329,975	646,550	316,575
15.	2010	821,625	1,557,450	736,125
	2011	795,160	1,574,880	779,720
16.	2010	474,390	913,640	439,250
	2011	506,880	982,080	475,200
17.	2010	334,110	656,750	322,640
	2011	306,525	596,300	289,775
18.	2010	303,300	594,805	291,505
	2011	333,060	655,200	322,140



### 3.3.34 Production time of hatchlings

From the investigation it was found that the hatchling production time of different species was not the same. It depends on local environmental condition, quality and availability of brood fish, demand of spawn, species involved in breeding etc. The average timing of spawn production from the 18 respondents of the surveyed hatcheries is given below (Table 3.26).

**Table 3.26.** Hatchlings production period of different fish species in the surveyed area.

Species	Month of the hatchling production		
	Starting	Peak	Ending
Rui	Late March	May	August
Catla	April	June	August
Mrigel	April	May	August
Calbasu	Late April	May	August
Bata	April	July	August
Silver carp	March	May	Late August
Grass carp	March	June	August
Common carp	February	April	November
Bighead carp	Late March	May	August
Punti	March	April	September

### 3.3.35 Problems and constraints faced by private fish hatchery owners

The government fish hatcheries faced a little problem because they received adequate facilities from the government. But most of the private hatchery owners faced different types of problem. The problems faced by the hatchery owners have been categorized under four general type, such as technical, economical, social and natural and these are shown in the following table (Table 3.27). During the investigation of different fish hatcheries most of the hatchery owners (77.78% and 72.22%) reported that lack of technical knowledge and failure of electricity supply (load shedding) in this sector are the main constraints which hampered the spawn production. Some owners (66.67%) claimed that

insufficient water in dry season also retarded the hatchery production. In view of economical problems 27.78% and 22.22% farm owners reported that lack of credit and lack of marketing facilities were the crucial obstacle for hatchery. They demanded easy loan system from the government and banks in this sector. The hatchery owners also faced some unwanted social problems like theft of fish, poisoning in pond, land leasing problem, joint partnership etc. 61.11% and 44.44% hatchery owners reported that theft of fish and poisoning in pond as enmity are great problem in rural area. Natural calamity also disturbed hatchery production. 22.22% hatchery owners indicated that flood washed away their stocking ponds and as a result production was decreased.

**Table 3.27.** Problem faced by the owners of fish hatcheries in the surveyed area.

Kinds of problems	No. of hatcheries	Percentage (%)
<b>A. Technical</b>		
1. Failure of electricity supply	13	72.22
2. Lack of technical knowledge	14	77.78
3. Insufficient water in dry season	12	66.67
4. Lack of fertilizers and chemical	0	0.0
5. Unavailability of feed	0	0.0
6. Disease	3	16.67
<b>B. Economical</b>		
1. Lack of credit	5	27.78
2. Lack of marketing facility	4	22.22
<b>C. Social</b>		
1. Theft of fish	11	61.11
2. Poisoning in pond as enmity	8	44.44
3. Toll collection by terrorist	0	0.0
4. Joint partnership	2	11.11
5. Leasing problem	4	22.22
<b>D. Natural</b>		
1. Flood (caused by heavy rain)	4	22.22
2. Other natural calamity	0	0.0

### 3.4 Discussion

Bangladesh is mainly a riverine country and it has a large number of water bodies such as ponds, canals, swamps, haors, baors khal-beels etc. Although culture fishery under scientific management is relatively a new gesture in Bangladesh but it expanded rapidly in the recent past. During 2006-2007 to 2009-2010 pond fish production increased from 8,11,954 mt to 11,40,484 mt representing more than 7.20 percent annual increase as against only 3.96 percent increase in overall fish production in the country (DoF, 2008 and 2011). This however created high demand for quality fish seeds. To supply the quality fish seeds government has established 77 fish seed multiplication farms which produced 7784.23 kg fry and private sector established 865 fish hatcheries which produced 489590.00 kg hatchlings (FRSS, 2011, DoF). In these hatcheries the production capacity is not equal. Because the productivity of hatchery depends on proper management of hatchery and operators skillness about induced breeding.

The present study deals with the present circumstantial status, management and problems of a total 18 hatcheries under the different upazillas of Rajshahi district. Among the 18 hatcheries, two were public and the rest of 16 were private hatcheries.

Several workers i.e., Rahman *et al.* (1987), Mohsin (2000), Kabir *et al.* (2001), Miah *et al.* (2002), Islam *et al.* (2002), Sarder *et al.* (2002), Amin (2005), Sarkar *et al.* (2005), Steeby and Avery (2005), Islam (2006), Bhuiyan *et al.* (2008) Rashid *et al.* (2009), Pheleps (2010) and Akankali, *et al.* (2011) worked on hatchery management and mentioned different criteria about hatchery management. But these works are not sufficient to find out the actual figure of such studies.

#### 3.4.1 Establishment of the hatcheries

In Bangladesh the fish hatchery was first established in 1960 when the induced breeding by hypophysation was started (Das, 1997). During the investigation of

the surveyed hatcheries it was observed that the maximum hatcheries were established in between 1991-95. There were also two govt. hatcheries. Both of them were established before the above period. Islam *et al.* (2002) observed that 20 hatcheries established in Rajshahi district are producing carp seeds since 1983 to date. In a study, Islam (2006) reported that in the district of Jessore, Jhenaidah and Kushtia the maximum (52.38%) fish hatcheries were established in between 1986-91.

#### **3.4.2 Occupation of the hatchery owners**

In the field investigation it was found that among 18 surveyed fish hatcheries 50% hatchery owners earn their livelihood from only hatchery business and 50% hatchery owners had other business with hatchery operation such as service, agriculture, fish farming etc. Amin (2005) reported that hatchery management was the main occupation for most of the hatchery owners in his surveyed area (four district of Bangladesh). Islam (2006) observed that 42.86% hatchery owners earned their livelihood from only hatchery business and 57.14% hatchery owners had other business such as service, agriculture etc. in south-western region of Bangladesh which is more or less similar with the present findings.

#### **3.4.3 Education status**

In the surveyed hatcheries it was found that 16.67%, 27.78%, 16.67%, 11.11% and 27.78% hatchery owners or managers had primary, high school, SSC, HSC and graduate to master's level education. But Rashid *et al.*(2009) found that 13.59%, 11.12%, 33.34%, 16.05% and 6.18% hatchery owners had primary, high school, SSC, HSC and graduation or post-graduation level education and 16.05% were illitrate in their study which was not similar with the present findings and varied with the result of Islam (2006) when he surveyed 21 fish hatcheries in south-western region of Bangladesh.

#### **3.4.4 Training status of the hatchery owners**

From the survey it was found that most of hatchery owners or managers (88.89%) got training from in country or abroad. Only two (11.11%) hatchery

owners had no training. The results is more or less similar to the findings of Islam (2006). Rashid *et al.* (2009) observed in their study that about 43.21% fish hatchery and nursery owners had no training while about 49.38% fish hatchery and nursery owners received short-term training from the Department of Fisheries (DoF) and / or from Bangladesh Fisheries Research Institute (BFRI).

#### **3.4.5 Source of fund for hatchery operation**

Regarding the sources of fund for hatchery operation it was observed that about 38.89% owners had their fund from their own sources, 16.67% of hatchery owners got their fund from own source and relatives, 05.55% of hatchery owners got fund from self and bank, 11.11% of hatchery owners received fund from only bank, 16.67% of owners from only mohazon and 11.11% owners got fund from govt. Islam (2006) observed that about 47.62% owners had funds for seed production from their own sources. In an another study Rashid *et al.*, 2009, found that the 52.65% owners used their own fund for farm installation and operation in Tangail district which was more in percentage than the present findings.

#### **3.4.6 Category of land ownership**

From the investigation it was found that about 55.56% hatchery owners used their own land, 22.22% owners used both own and leased property, 11.11% owners used completely leased property and 11.11% got land from government. This observation is more or less similar to Molla, *et al.* (1999). Islam (2006) reported that about 61.90% owners used their own land for hatchery purposes and the rest 38.10% were both leased and own land. His result was nearly similar to the present findings.

#### **3.4.7 Transportation facilities**

During the investigation it was observed that the vehicles facilities were not well developed. The hatchery owners had no transportation facilities of their own. Only two public hatcheries had their own vehicles like pick-up, motorcycle, van etc. The vehicles used for hatchlings and brood fish transportation can be divided into

two categories i.e. mechanized such as mishuk, tempo, pick-up, minitruck, motorcycle etc and non-mechanized such as cycle, rickshaw, van etc. This is similar to the observation of Shahidullah (1978), Naser and Mazumder (2004). Islam (2006) also observed no hatchery owners had transportation facilities of their own in their studied area.

#### **3.4.8 Communication facilities of hatcheries**

In the surveyed area it was found that most of the hatchery owners were satisfied about their location of the hatcheries. About 27.78% owners mentioned the facility as excellent while 55.55% and 16.67% owners mentioned the facility as good and not good respectively. Islam (2006) mentioned that about 52.38% hatchery owners were highly satisfied for their existing communication facilities and that was more or less similar to the present findings. Rashid *et al.* (2009) mentioned that about 69.9% of fish hatchery and nursery owners reported the road communication facilities as excellent 29.62% as well and only 2.48% as not good in his study area. These results slightly differ from the present findings.

#### **3.4.9 Status of employees of hatcheries**

Specialist person for induced breeding called “fish doctor”, both skilled and unskilled labourers were found in the surveyed hatchery. Labourers work as permanent or temporary basis. Mean monthly salary of specialist fish doctors and skill labourers were found as Tk. 8941.176 ± 2006.882 and Tk. 6652.174 ± 1256.21. The mean monthly and daily salary of unskilled labourers were found as Tk. 4423.077 ± 870.084 and Tk. 156.667 ± 12.111. According to Islam (2006), the mean monthly salary of skilled labourers was Tk. 3895.24 ± 332.38 and mean daily salary of unskilled labours was Tk. 87.14 ± 3.73 in the surveyed hatcheries of south-western region of Bangladesh. The total number of permanent workers per hatchery ranged from 2 to 6 with an average of 3.55 ± 1.37. Islam *et al.* (2002) reported the number of permanent workers per hatchery ranged from 2 to 8 with an average of 4.35 ± 1.38 in the Rajshahi district which is nearly similar to the present findings. The number of workers varied according to hatchery activities.

#### **3.4.10 Area of hatchery**

From the survey report it was observed that the area of 33.33% hatcheries were in between 1-5 decimals, 38.89% hatcheries were in between 6-10 decimals and 27.78% hatcheries were established in between 11-15 decimals area. There are also two government hatcheries and they have much more area than other private hatcheries. Islam (2006) reported that 61.90% hatcheries were constructed with small lands (1-10 decimals). But Rashid *et al.* (2009) observed in Mymensingh region that the fish hatcheries and nurseries were divided into 3 categories: below 2 acres (8.64%), 2 to 5 acres (38.27%) and more than 5 acres (53.09%).

#### **3.4.11 Number of ponds in the hatchery**

In the surveyed area the maximum number of pond was 8 and the minimum was 2 with an average of 5. During the investigation it was observed that every fish hatchery owner had their own brood stock ponds. As regard to ownership it was observed that the ponds were their own or leased. This result slightly differs from that of Islam (2006) who surveyed fish seed farms in three districts of Bangladesh and reported that the maximum number of pond was 6 and the minimum was 4. Islam *et al.* (2002) reported that the average number of stocking and nursery ponds were  $3.6 \pm 1.46$  and  $5.65 \pm 2.51$  in their studied hatcheries.

#### **3.4.12 Physicochemical and biological characteristics of ponds**

During the study period the maximum temperature was recorded as 29°C and the minimum was 26°C with an average of  $27.63 \pm 0.97^\circ\text{C}$ , the maximum dissolved oxygen was recorded as 9.0 mg/l and the minimum was 6.5 mg/l with an average of  $7.92 \pm 0.70$  mg/l. Among the surveyed hatcheries the maximum pH was 8.0 and the minimum was 7.0 with an average of  $7.43 \pm 0.38$ . Dissolved CO<sub>2</sub> was recorded as maximum 12.0 mg/l and the minimum was 8.0 mg/l with an average of  $10.07 \pm 1.17$ . The highest value of alkalinity was recorded 120 mg/l and the minimum was 90 mg/l with an average of  $102.78 \pm 7.31$  mg/l. The highest value of total hardness was recorded as 130.00 mg/l and the lowest was 100.00 mg/l with a mean of  $110.83 \pm 7.42$  mg/l.

Several authors described the effect of physicochemical variables of water for hatchery management. The findings of this work was also compared with the observation of Islam *et al.* (1978), Bhowmick *et al.* (1978), Miah *et al.* (1981), Alam *et al.* (1985), Haque and Ahmed (1993) and Bhuiyan *et al.* (2008b) and that was found more or less similar with the present work.

Sarkar *et al.* (2005) mentioned that water temperature ranged from 28.0°C to 31.8°C, water pH (Potenz Hydrogen) ranged from 6.49 to 7.43, dissolved oxygen ranged from 2.15-6.74 mg/l, total alkalinity ranged from 87.33-114.00 mg/l during the study of water quality measurement of farmers' ponds in Mymensingh district.

#### **3.4.13 Occurrence of fish disease in the hatcheries**

During the survey about 16.67% hatchery owners reported that there were no fish disease in their farms, while 83.37% owners reported that there were seldom attack of fish disease. In the survey area it was observed that most of the hatchery owners were aware of fish diseases and they always maintained a hygienic atmosphere in their hatcheries. Islam (2006), in his study reported that in the district of Jessore, Jhenaidah and Kushtia about 95.24% owners claimed there were no fish disease in their farms, which is slighter more than the present findings. But Amin (2005) reported that the brood fish of 87% hatcheries were found infected by argulosis when he studied 100 private hatcheries and 40 nurseries in 4 districts of Bangladesh. This result also differs slightly with the present findings.

#### **3.4.14 Source of water supply and water discharge system**

Most of the hatchery owners in the surveyed area reported that they used only underground water for hatchery purposes. But only 2 hatchery owners out of 18 hatcheries reported the use of mixed water of both underground and pond water. The discharge of water from the hatcheries was maintained through drain and some hatcheries maintained a good drainage system.



### **3.4.15 Number and water carrying capacity of overhead tank in the surveyed hatchery**

Normally each hatchery had one overhead tank and it was made of cement, bricks, rods, etc. and was placed over RCC pillar from the ground. It is the main reservoir for water used for hatching purposes. The average number of overhead tanks was  $1.00 \pm 0.00$ . The volume of overhead tanks ranged from  $13.25 \text{ m}^3$  to  $73.47 \text{ m}^3$  with an average of  $37.12 \pm 15.78 \text{ m}^3$ . The water carrying capacity of overhead tanks ranged from 13249.81 to 73474.87 litre with an average of  $37114.80 \pm 15782.35$  litre. Islam *et al.* (2002) also found the number of overhead tanks as 1 to 2 with an average of  $1.15 \pm 0.36$ , in different fish hatcheries of Rajshahi district.

### **3.4.16 Circular breeding tanks**

Circular breeding tanks were also made of bricks and cement. Among the 18 surveyed hatcheries 4 circular breeding tanks were found in different 4 hatcheries. The volume of circular breeding tanks ranged from  $3.270 \text{ m}^3$  to  $12.812 \text{ m}^3$  with an average of  $6.81 \pm 4.24 \text{ m}^3$ . The water carrying capacity of circular breeding tanks was found as 3269.70 litre to 12811.90 litre with an average of  $6814.66 \pm 4238.40$  litre. The finding is more or less similar to the work of Islam *et al.* (2002).

### **3.4.17 Circular hatching tanks**

The circular hatching tanks were also made of bricks and cement. It was found that among the 18 surveyed hatcheries the number of circular hatching tanks varied from 1 to 3 with an average of  $2.00 \pm 0.93$  and volume varied from  $3.270 \text{ m}^3$  to  $11.210 \text{ m}^3$  with an average of  $6.91 \pm 3.22 \text{ m}^3$ . The water carrying capacity of circular hatching tanks was found 3269.70 litre to 11210.41 litre with an average of  $6899.34 \pm 3201.80$  litre. This is more or less similar findings of Islam *et al.* (2002).

### 3.4.18 Houses or cisterns

Cemented houses or cisterns were found in all the surveyed hatcheries. The number of houses ranged from 3 to 13 with an average of  $6.44 \pm 2.55$ . The maximum volume of each house was found  $4.06 \text{ m}^3$  and the minimum was  $1.73 \text{ m}^3$  with an average of  $3.13 \pm 0.57 \text{ m}^3$ . The total volume of the houses was  $10.14 \text{ m}^3$  to  $43.94 \text{ m}^3$  with an average of  $20.15 \pm 9.27 \text{ m}^3$ . The total water carrying capacity of the houses was found as 10125.03 to 43940.00 litre with an average of  $20139.80 \pm 9265.87$  litre. The house was used for brood fish conditioning and rearing of fry with the help of hapa.

### 3.4.19 Jars or bottles

Funnel shaped jars or bottles were found in the fish hatchery for hatching the eggs. Mainly these were made of cement or steel sheets. The number of jars ranged from 4 to 19 with an average of  $10.50 \pm 3.167$ . The volume of bottles ranged from  $1.292 \text{ m}^3$  to  $8.056 \text{ m}^3$  with an average of  $5.21 \pm 1.69 \text{ m}^3$ . The total water carrying capacity of jars ranged from 1291.72 to 8053.15 litres with an average of  $5208.43 \pm 1685.25$ .

### 3.4.20 Chemical used for washing tanks, houses and bottles

During investigation it was found that the chemicals and medicines used in the hatchery activities in the surveyed area were more or less similar. Normally potash, bleaching powder, detergent powder, formalin, copper sulphate, methyl-blue, lime etc. were used to clean the overhead tanks, breeding tanks, hatching tanks, houses or cisterns and bottles or jars. Potash was used in higher number of hatcheries (15) out of 18 surveyed hatcheries and then formalin, it was used in 9 hatcheries.

Kabir *et al.* (2001) reported that 45 private and 11 government farms from 9 selected districts of Bangladesh used potash, lime as chemicals to clean the hatchery setup. Islam (2006) mentioned that bleaching powder, detergent powder, formalin, malachite blue were also used in different fish hatcheries in south-western region of Bangladesh.

#### 3.4.21 Source of brood fishes

In the surveyed area most hatchery has the provision of stocking the brood fishes. The number of brood fish ponds varied from 2 to 4. Area of the ponds ranged from 0.5 to 1.75 hectares. Out of 18 surveyed hatcheries 15 hatchery owners (83.33%) had own brood fish pond. Besides this the hatchery owners collected brood fishes from other farmers' ponds, rivers, local markets, brood banks etc. Islam *et al.* (2002) found that most of the hatchery owners used brood fishes for induced breeding from their own ponds in his surveyed area. Amin (2005) reported that about 66% of the hatchery owners collected brood fishes from their own ponds and from ponds of neighbouring areas.

#### 3.4.22 Brood fish stocking and rearing

A hatchery, should have healthy and fresh brood fishes to produce healthy fry. For this, in the surveyed area it was found that most of the hatchery owners strictly followed some measures for good brood fish management. Generally 10 species of brood fishes were used in the surveyed hatcheries for the induced breeding. Among them 5 fish species were native and 5 were exotic.

Akankali *et al.* (2011) recommended rectangular ponds of 70×20 m<sup>2</sup> or 80×25 m<sup>2</sup> for brood fish management. He discussed different aspects of brood stock management, such as collection procedure of brood fishes, handling and transportation of brood fishes, a certain level of water maintenance in brood fish pond, regularly weed clearance from brood stocking ponds, removal of predatory and unexpected wild fishes, pond fertilization, application of supplementary feed etc. More or less similar observations were found in the surveyed hatcheries.

#### 3.4.23 Stocking density of brood fishes

In the present study the stocking density of brood fishes were recorded. Stocking density of brood fishes are dependant on different species. The stocking density of rui (*Labeo rohita*) ranged from 25% to 35% with an average of  $26.67 \pm 3.03$ , catla (*Catla catla*) 8% to 20% with an average of  $14.17 \pm 3.75$ , mrigel (*Cirrhina mrigala*) 5% to 15% with an average of  $10.06 \pm 3.35$ , silver carp

(*Hypophthalmichthys molitrix*) 14% to 25% with average of  $16.17 \pm 2.75$ , raj punti (*Puntius gonionotus*) 5% to 10% with an average of  $6.38 \pm 2.07$ , calibaush (*Labeo calbasu*) 4% to 5% with an average of  $4.40 \pm 0.50$ , grass carp (*Ctenopharyngodon idella*) 5% to 10% with an average of  $6.23 \pm 1.72$ , common carp (*Cyprinus carpio*) 5% to 15% with an average of  $9.44 \pm 2.31$ , bighead carp (*Aristichthys nobilis*) with 5% to 8% with an average of  $5.75 \pm 1.73$  and bata (*Labeo bata*) 8% to 25% with an average of  $12.67 \pm 3.87$ . The stocking density of brood fishes in the surveyed hatcheries was found more or less similar to that of Islam *et al.* (2002), Islam (2006), Musa and Bhuiyan (2007). Bhuiyan *et al.* (2008) also discussed the brood fish management and maintenance in the similar way.

#### **3.4.24 Supplementary feeds used for brood fishes**

To get better seed production and better growth of brood fishes the different types of supplementary feeds were used in the 18 surveyed hatcheries including oil cake 15% to 35% with an average of  $22.22 \pm 4.28$ , rice bran 15% to 40% with a mean of  $21.39 \pm 5.64$ , boiled rice 12% to 20% with a mean of  $17.00 \pm 3.46$ , wheat bran 10% to 20% with an average of  $16.13 \pm 3.30$ , blood wastage 10% to 15% with an average of  $11.75 \pm 3.36$ , flour 10% to 20% with an average of  $14.14 \pm 3.09$  and fish meal 15% to 45% with an average of  $22.78 \pm 6.47$ .

Various workers mentioned the usefulness of supplementary feeding of brood fishes for better seed production, i.e. Ali *et al.* (1982), Islam and Dewan (1988), Bhuiyan and Rahman (1989) Islam and Bhuiyan (1990), Haroon *et al.* (1994), Rahman *et al.*, (1997), Mohsin (2000), Kabir *et al.* (2001), Amin (2005), Steeby and Avery (2005), Musa and Bhuiyan (2007), Bhuiyan *et al.* (2008a), Rashid *et al.* (2009) and Akankali *et al.*, (2011).

#### **3.4.25 Fertilizers used for stocked fishes**

In the surveyed hatcheries it was found that most of the hatchery operators used organic and inorganic fertilizers for increasing the natural food production. Cowdung, poultry wastes, urea, TSP, MoP were applied in the brood fish ponds weekly or fortnightly at the rate of DoF recommendation (DoF, 2002a and 2008).

Islam *et al.* (1997), Miah *et al.* (1998), Mohsin (2000), Saha *et al.*, (2004), Bhuiyan *et al.* (2008b) and Abraham *et al.* (2010) supported that cowdung, urea, TSP, MoP were necessary for pond fertilization and that was found similar work with the present findings.

#### **3.4.26 Conditioning of brood fishes**

Brood fishes are needed for conditioning before induced breeding. During investigation it was marked that the conditioning period varied from species to species. The maximum conditioning time was 12 hours and the minimum time was 6 hours with an average of  $9.56 \pm 2.12$ . The males and females were conditioned in separate tank.

#### **3.4.27 Egg collection time from the brood fishes**

During investigation it was observed that the hatchery owners collected eggs from brood fishes only one time. But many hatchery owners responded that sometimes it may be twice or thrice during the breeding season.

#### **3.4.28 Inducing agent for artificial breeding**

Mainly two types of hormones are used for induced breeding, such as pituitary gland extract (PG) and human chorionic gonadotropin (HCG). PG was used for rui, catla, mrigel, calibaush, bata, silver carp, common carp, grass carp, bighead carp and raj punti to induce the fish. But PG and HCG were used for silver carp and bighead carp to induce the fish, In this case PG was used as a first dose and HCG was used as a second dose.

Several workers, i.e. Chaudhury and AliKunhi (1957), Rahman *et al.* (1985), Rahman *et al.* (1988), Kohinoor *et al.* (1995), Haque *et al.* (1995), Haque *et al.* (1996), Islam *et al.* (1996), Alam and Bhuiyan (1999), Hossain (2001), Islam *et al.* (2002), Bhuiyan *et al.* (2006), Bhuiyan *et al.* (2008) used PG, HCG to induce the different types of carp fish which is similar to the present work.

#### **3.4.29 Quantity of fry production**

Out of 18 surveyed hatcheries it was observed 9 hatcheries annually produced 300 kg to 400 kg hatchlings, 2 produced 400 kg to 500 kg, 3 produced 500 kg to 600

kg, 3 produced 600 kg to 700 kg and only one hatchery produced 700 kg to 800 kg of hatchlings in the both years of 2010 and 2011. The total fry production of 18 surveyed hatcheries was 8,200 kg in 2010 and 8380 kg in 2011.

In this regard Islam and Dewan (1986), Dewan *et al.* (1988), Kabir *et al.* (2001), Haque *et al.* (2003), Amin (2005), Zaman *et al.* (2006), Islam (2006) worked to find out the annual pond fish and nursery fish production and surveyed different govt. and private fish hatcheries of different region of Bangladesh to assess the annual fry production of hatcheries. With comparison of those works it was found that the present findings about the annual fry production of hatcheries was satisfactory.

#### **3.4.30 Demand of hatchlings**

In the surveyed area to the question demand of hatchling maximum hatchery owners answered rui as a single species (33.33%), followed by silver carp (27.78%), bata (22.22%), common carp (11.11%) and mrigel (5.56%), During investigation it was observed that the fish farmers and nursery owners of different part of the country specially northern region of Bangladesh are the main customer of these hatcheries.

#### **3.4.31 Marketing system of hatchlings**

In the surveyed area it was found that most of the hatchery owners produced hatchlings and supplied those within the local area. 9 hatcheries (out of 18 surveyed hatcheries) sold their fingerlings to the traders or nursery owners of Rajshahi district. 4 hatchery owners supplied their hatchlings to the traders or hatchery owners of different districts of Rajshahi division, 5 hatcheries sold their hatchings to the seed traders or farmers who came from different parts of Bangladesh.

#### **3.4.32 Price of inputs and outputs**

Price of inputs affect the cost of productions. Market prices of inputs depend mainly on their availability. During investigation it was recorded that the average market price of cowdung was Tk. 2/- kg and the prices of inorganic fertilizers such as urea, TSP and MoP were Tk. 20/- kg, Tk. 22/- kg and Tk, 15/- kg respectively.

Prices of artificial feeds such as rice bran, wheat bran, mustard oil cake, flour and fish meal were Tk. 15/- kg, Tk. 20/- kg, Tk. 22/- kg, Tk. 22/- kg and Tk. 24/- kg respectively. The cost of lime was Tk. 11/- kg. The hormone PG was purchased at Tk. 5/- piece and HCG Tk. 200/ ample. The average labour cost of permanent type was Tk. 4500/ month with food and shelter and temporary Tk. 150/ day with food. The leasing cost inputs for land and pond was Tk. 1,40,000/ to 1,75,000/ per hectare per year.

Sale price of fish seeds seriously affected the profitability of fish seed production. Price of fish spawn of natives species, i.e. rui, catla, mrigel, calibaush and bata ranged from Tk. 1,000/ kg to Tk. 3,000/ kg and price of fish spawn of exotic species i.e. silver carp, common carp, grass carp, bighead carp and punti ranged from Tk. 800/- kg to Tk. 2800/- kg.

Kabir *et al.* (2001) also analysed the price of inputs (feed and fertilizers) to evaluate the economic performance of producing fish seeds in government and private farms. The similar works were also done by Islam (2006), Musa and Bhuiyan (2007) to find out the economic performance of surveyed fish hatcheries.

### **3.4.33 Cost and returns of fish seed production**

Cost of production is one of the determining factors for net earning in fish seed production. But in the surveyed area it was observed that the fish seed production was the profitable business. In 2010, the total cost involved in 18 surveyed hatcheries for the production of spawn ranged from 3.033 lakh Tk. to 8.216 lakh Tk. with an average of  $4.530 \pm 1.580$  lakh Tk., gross return ranged from 5.812 lakh Tk. to 15.574 lakh Tk. with an average of  $8.781 \pm 2.922$  lakh Tk. and net profit was in between 2.697 lakh Tk. to 7.361 lakh, Tk. with an average of  $4.251 \pm 1.396$  lakh Tk. Similarly in 2011 among the surveyed hatcheries the total cost involved was in between 3.065 lakh Tk. to 7.951 lakh Tk. with an average of  $4.665 \pm 1.564$  lakh Tk., gross return was in between 5.963 lakh Tk. to 15.748 lakh Tk. with an average of  $9.127 \pm 3.099$  lakh Tk. and net profit was in between 2.928 lakh Tk. to 7.792 lakh Tk. with an average of  $4.461 \pm 1.545$ .

Kabir *et al.* (2001), Islam *et al.* (2002), Miah *et al.* (2002), Musa and Bhuiyan (2007) and Rashid *et al.* (2009) worked on the fish hatchery and reported that fish seed production was an obviously profitable business which also support the present findings.

#### **3.4.34 Production time of hatchlings**

Production period of hatchlings are dependent with species, localized environmental condition and brood stock quality. During the investigation it was found that the peak months of hatchling production period of rui, catla, mrigel, calibaush, bata, silver carp, grass carp, common carp, bighead carp and punti were. May, June, May, May, July, May, June, April, May and April.

This finding can be compared favourably with the work of Parameswaran *et al.* (1970), Royce (1972), Haque and Ahmed (1993) and Bhuiyan *et al.* (1998).

#### **3.4.35 Problems and constraints faced by fish hatchery owners**

In the surveyed area most of the private hatchery owners faced different types of problem. The problems faced by the hatchery owners have been categorized under four general type, such as technical, economical, social and natural. During investigation most of the hatchery owners (77.78% and 72.22%) reported that lack of technical knowledge and failure of electricity supply (load shedding) are the main constraints. Some owners (66.67%) claimed that insufficient water in dry season also retarded the hatchery production, 27.78% and 22.22% farm owners reported that lack of credit and lack of marketing facilities are the crucial obstacle for hatchery. 61.11% and 44.44% hatchery owners reported that theft of fish and poisoning in pond as enmity are great problem in rural area. Natural calamity also disturbed hatchery production. 22.22% hatchery owners indicated that flood washed away their stocking ponds and as a result production was decreased.

Islam *et al.* (2002) reported another point, they found inbreeding and hybridization are the major problem for hatchery management. Amin (2005), also found electricity is a problem (load shedding) when he studied on brood stock management and seed production in Bangladesh. Miah *et al.* (2002) investigated different fish seed multiplication farms in the district of Jessore, Jhenaidah and Narail in Bangladesh and pointed out some problems of FSMFs which was very similar to the present findings.



# **CHAPTER 4**

## *Induced Breeding of Clarias batrachus*

## CHAPTER 4

### INDUCED BREEDING OF *CLARIAS BATRACHUS*

#### 4.1 Introduction

Artificial propagation of fishes is done by induced breeding technique. Hypophysation or induced breeding is a technique of breeding of fishes by applying pituitary gland or hypophysis.

For the development of large scale fish culture, a dependable source of quality fish seed is a fundamental prerequisite. Induced breeding of endemic major carps has been established as a dependable source of fish seeds since the mid 1960s (Ali, 1967) in hatcheries for production of fry/fingerlings which contributes significantly to the overall aquaculture production of Bangladesh.

Indigenous walking catfish *Clarias batrachus* (Linn.) is a popular small fish species of Bangladesh. Bangladeshi people prefer this fish for its nutritional value and delicious taste. Small indigenous fishes (SIF) have great potential for aquaculture in this country which has not been utilized fully. Large fishes require large and permanent water bodies as their appropriate habitats. Therefore, often, culture of large fishes remains beyond the reach of poor people. On the other hand, small fishes especially air breathing fishes, can be cultured in relatively small and shallow water bodies, such as ditches, small ponds, canals, etc. Therefore, culture of small native fish species, *C. batrachus* in particular would be the viable means for increasing fish production in the country through which common rural people can benefit. Once indigenous walking catfish (*C. batrachus*) was abundantly available in almost all freshwater systems of Bangladesh. However, in recent years, its population has been declining very rapidly due to ecological degradation, indiscriminate fishing, use of pesticides and fertilizers, destruction of habitats, obstruction of breeding migration, management failure etc. (Anon, 1999). As natural population

of *C. batrachus* is dwindling fast. Planners, policy makers, aquaculturist and fisheries biologists are thinking of its cultivation through intensive farming to sustain and augment production. Controlling entire life cycle is key to success for farming of any fish species. Production of fry and fingerlings as per demand is a part of controlled aquaculture and is pivotal for success of fish farming. Ever since the use of hormone in first successful breeding of fish in Brazil (Cardoso, 1934), artificial fish breeding with different hormone materials found its wide use in aquaculture.

In India the first attempt was made by Khan (1938) who used mammalian pituitary gland to induce spawning of mrigel (*Cirrhina mrigala*) and succeeded in ovulation. Chaudhury and Alikunhi (1957), Alikunhi *et al.* (1957) and Chaudhuri (1960) successfully induced the Indian carps to breed with pituitary injection. The outstanding first success of hypophysation of Indian major carps in Bangladesh was done by Ali in 1965 in the Fisheries Research Station, Chandpur (Ali 1967) and later on by Haque (1975), Islam and Chowdhury (1976), Alam (1983) and Ahmed (1983). In general, artificial breeding with the help of hormones is a common practice nowadays.

Different hormone preparations are used for artificial breeding purposes including PG (pituitary gland), HCG (human chorionic gonadotropin), LH (luteinizing hormone), ovaprim, ovatide etc. But problems of standardization regarding pituitary and other hormone potency specific to the hypophysation techniques remain unsolved. Although a few works such as Stevens, 1966; Sinha, 1971; Fijan, 1975; Harvey and Hoar, 1979; Marte, 1989 and Akankali *et al.* 2011 have been done on other variables such as initial stage between the injection time and ovulation after the last injection, the dose of injection, seasonal and environmental conditions etc, but full scale information is still scanty.

During the past decades, PG, HCG were used successfully in fish breeding. The first success in induced spawning of *C. batrachus* in India was achieved by

Ramaswami and Sundararaj (1957) using homoplastic pituitary glands. Khan (1972), Khan and Mukopadhyay (1975), Ahmed *et al.* (1981), Ahmed *et al.* (1985). Thakur and Das (1985) and Mustafa *et al.* (1986) provided basic information on induced breeding of *C. batrachus* with a view to mass production of seeds. Inducing hormonal materials are scarce and expensive in Bangladesh. The present work was undertaken with an objective to determine an optimum dose of PG and HCG for artificial breeding of the fish (*C. batrachus*).

#### **4.1.1 Advantages of induced breeding**

Proper fertilization, for higher fry production, for less mortality of fish fry, for good acclimatization for transportation and for high survival rate of fry are the advantages of induced breeding.

#### **4.1.2 Hybridization**

The mating or crossing of two individuals or lines of dissimilar genotype is known as hybridization. The chief objective of hybridization is to create genetic variation. When two genotypically different species are crossed the genes from both the parents are brought together in  $F_1$ . Segregation of and recombination among the genes that are heterozygous in  $F_1$  would produce many new gene combinations in  $F_2$  and the latter generations. As a result quality of individuals will be improved.

Based on the taxonomic relationships of the parents involved hybridization may be classified into two broad groups: (a) intervarietal and (b) distant hybridization.

#### **Advantages of hybridization**

- i. Growth of hybridized fishes is rapid.
- ii. Satisfactory rate of production.
- iii. Deformed hatchlings are rarely produced.
- iv. More disease resistant.
- v. Emergency breeding is possible for hybridization.

### **Disadvantages of hybridization**

- i. Extinction of native species is the principal disadvantage of hybridization.
- ii. Shape and size of hybridized fishes will be changed.
- iii. The price of hybridized fishes is less than other fishes.
- iv. The taste of hybridized fishes is less than other fishes.
- v. Sometime mortality rate is more than other fishes.
- vi. The feeding rate of hybridized fishes is more than other fishes.

### **4.1.3 Cross breeding**

Mating of individuals from entirely different races or even different species is called cross breeding. Cross breeding produces sterile hybrids in comparison of normal out breeding. Crosses between different species of major carps, exotic carps, also between the native carps and exotic carps, between the native catfishes and also between the native and exotic catfishes are practiced in different hatcheries of our country.

The hatchery owners gathered a number of experiences while they were doing cross breeding in fishes. There are also advantages and disadvantages of cross breeding in fishes which are as follows:

#### **Advantages-**

- i. The rate of fry production is satisfactory.
- ii. The growth of cross bred fishes is rapid.
- iii. The fry get more viability, more immunity through cross breeding.
- iv. The size of cross-bred are very big in comparison to normal breeding.

#### **Disadvantages-**

- i. Cross breeding produces sterile offspring so it plays an important role on the extinction of native species.
- ii. Changes in shape and size of cross bred fishes are not easily accepted by the consumers.
- iii. The taste and cost of cross bred fishes are less than other fishes.
- iv. In many cases some abnormalities are found in the offspring.

#### **4.1.4 Inbreeding**

The process of mating of con-specific individuals, which are more closely related than the average of the population to which they belong is called inbreeding. Inbreeding occurs due to the absence of exchanging system of brood fishes. The following effects are found when inbreeding going on for induced breeding.

- i. Inbreeding increases the lethality in a population.
- ii. Survivability, fertility, viability, fecundity will be decreased in a population due to inbreeding.
- iii. For closely related individuals homozygosity of fry will be increased.
- iv. In inbreeding system genotypic frequency of the fishes may be changed.
- v. Body structure may be deformed.
- vi. Growth rate will be hampered.

#### **4.1.5 Problems and constraints of induced breeding**

Despite prolonged practice and considerable refinement, the induced breeding or hypophysation procedure still now face some problems which are as follows:

- i. There will be inbreeding and hybridization problem.
- ii. Negative selection of brood fishes.
- iii. Lack of scientific knowledge about PG, HCG and the hormone dose preparation.
- iv. Lack of good brood fishes.
- v. Rough handling of brood fishes.
- vi. Brood fish poaching.
- vii. Lack of skill manpower regarding induced breeding.
- viii. Sudden death of fry.

## **4.2 Materials and Methods**

The credibility of the result of a scientific result depends to a great extent on the appropriate methodology used in the research. Improper methodology very often leads to erroneous result. So great care was taken in following a scientific and logical methodology for carrying out this research. Experimental and analytical methods have been followed in this research.

### **4.2.1 Study area and period**

The experiments were carried out in the ponds and hatcheries of the fish seed multiplication farm, Arif Matsha Hatchery, Court Station, Mollapara, under Rajpara thana, Rajshahi district. However, some of the analytical works were carried out at the Fisheries Research Laboratory of Zoology Department, University of Rajshahi. The hatchery owner was requested and persuaded to provide all the hatchery facilities regarding this type of experiment. The study was carried out during the period from April to July of 2010 and 2011. The hatchery was established in 2008 with a total area of 2.4 acres. There were 5 ponds, one overhead tank, three circular breeding and circular hatching tanks, 8 cisterns and 13 jars/bottles. The breeding cisterns were provided with showers for spawning. Each cistern was provided with one inlet for incoming water and a outlet for passing out of excess water. Jar/bottles were also provided with water supply and side net for easy hatching of eggs. The cistern and jars/bottles were situated under a tin shed.

### **4.2.2 Selection of brood ponds**

In the hatchery among 5 ponds, one pond was selected for brood fishes. The pond was in an open place with a suitable physico-chemical condition for the rearing of breeders. The pond was well protected from flood and drought. The water quality of hatchery was measured and recorded during the study period. It is apparent from the data that the supplied water was reasonably good for hatchery use.

### 4.2.3 Preparation of brood fish ponds

The brood fishes provide several products for starting new generations of fishes. Smaller ponds are recommended for the harvesting and selection of brooders. Pond size ranging from 200-1000 m<sup>2</sup> was adequate. Let the number, size and variety of species of brooders guide the pond size.

Prior to stocking, ponds were dried up and bottom was adequately ploughed and after a few days filled with ground water and limed (CaCO<sub>3</sub>) at the rate of 1 kg/decimal. Thereafter the ponds were left for about 7 days to allow the lime to complete the chemical reactions. The ponds were then manured with cowdung at the rate of 10 kg/ decimal. Then the ponds were fertilized with urea, triple super phosphate (TSP) and muriate of potash (MoP) at the rate of 100 g/ decimal, 200 g/ decimal and 50 g/ decimal respectively. The organic and inorganic fertilizers were used to ensure adequate production of food organisms for breeders. Brood fishes were stocked in an area with adequate security and easy access. Rectangular shaped ponds of (75 × 20) m<sup>2</sup> or (80 × 25) m<sup>2</sup> are adequate.

### 4.2.4 Source of brood fishes

Mature and healthy *C. batrachus* (magur) of both sexes were collected from the fish traders of Court Station Market, Shahebbazzar and New Market of Rajshahi City, a few months prior to breeding season. Then the fishes were reared in the selected pond in the hatchery during the study period. Usually 1-2 years old healthy uninjured fishes were collected.

### 4.2.5 Water qualities of brood ponds

The water quality of brood fish ponds were measured and strongly maintained due to the better health of brood fishes. The result of measured water quality is provided in Table 4.1. During the study period from April to July of 2010 and 2011 the water qualities of brood fish ponds such as water temperature (°C), dissolved oxygen (DO), hydrogen ion concentration (pH), dissolved carbondioxide (CO<sub>2</sub>), alkalinity, total hardness were noted. The physico-chemical



variables were measured by Celsius thermometer and Hach's Model FF-1A Fish Farmer's Water Quality Test Kit. It is apparent from the data that the water quality of brood fish pond was reasonably good for the health of brood fishes.

**Table 4.1.** Water quality variables of brood fish ponds during the breeding season of 2010 and 2011 (April to July).

Year	Month	Date	Temperature (°C)	Dissolved oxygen (mg/l)	Hydrogen ion concentration (pH)	Dissolved carbon dioxide (mg/l)	Alkalinity (mg/l)	Total hardness (mg/l)
2010	April	01.04.10	29.5	8.5	8	10	115	125
		15.04.10	30	8	7.8	12	105	120
	May	01.05.10	29	7.5	7.4	13	105	115
		15.05.10	30.5	7.5	7.2	12	100	110
	June	01.06.10	29.5	7	7.5	12	95	105
		15.06.10	30	6.5	7	10	90	105
	July	01.07.10	31	6.5	6.8	9	95	100
		15.07.10	29	6.5	6.5	8	90	95
2011	April	01.04.11	29	8	8	14	110	120
		15.04.11	28	7.5	7.5	12	105	115
	May	01.05.11	30	8	7.4	10	100	110
		15.05.11	29.5	7.5	7.5	10	90	105
	June	01.06.11	29.5	7	7.5	10	90	105
		15.06.11	30	6.5	7	9	85	98
	July	01.07.11	29	7	7.5	9	95	105
		15.07.11	28.5	6.5	7	8	98	95
Mean± SD			29.50± 0.75	7.25± 0.66	7.35± 0.41	10.50± 1.79	98.00± 8.33	108.00± 9.06

#### 4.2.6 Maintenance of the brood fishes

Brood fish maintenance involves caring of the brooders from the time the fish was captured and brought for breeding to the time of spawning, stripping and returned. Brooders could be obtained from the wild or fish pond, Handling and transportation of brood fishes from the wild was carefully done. Brood fishes from the wild may be infected. In that case parasite if any was removed with a formaldehyde bath.

Feeding of brood stock is important. If adequate feed is not administered to the brood stock, cellular modifications in the hypophysis and a reduction of secretions in gonadotropins occur. There is therefore the need for proper feeding prior to breeding. The brood fishes were fed with a supplementary diet composed of fish meal, mustard oil cake, wheat bran, rice bran, vitamin and mineral premix. The food was administered everyday with the proportion of body weight.

#### **4.2.7 Selection of brood fishes for breeding**

Success in an experiment for induced breeding of fish depends largely on proper selection of suitable breeders prior to each experimental trial. The brood fishes were netted out of the pond and sexed on site. Only healthy and disease free individuals were selected.

#### **4.2.8 Sex determination**

Fishes are sexually dimorphic, that is, they appear in two different sexes. Morphological differences are more or less the same in all the species of various genera of fishes, except for the breeding season, when the gravid female becomes obvious by the bulged-out belly. For breeding purposes it is necessary to separate male and female rapidly and accurately through some external characters.

#### **4.2.9 Characteristics of male brood fish**

- i. The male is smaller than female in body length.
- ii. The body colour of male is slightly brown.
- iii. The abdomen of male is creamy, smooth and slender.
- iv. Small black spot present at the dorsal fin and a large black ring is present at the end of dorsal fin.
- v. In case of male the genital opening is located between the anus and the base of the anal fin.
- vi. The urinogenital papilla is an elongated tube like structure and triangular at its base.

vii. Two-thirds portion of genital papilla hangs freely from the body of its posterior, even touching the base of the anal fin.

viii. The sex-ratio of male : female is almost 1 : 1.

#### **4.2.10 Characteristics of female brood fish**

- i. The female is greater than male in body length.
- ii. The body colour is deep gray or more yellowish.
- iii. The abdomen is swollen and more bulky due to ripe ovary and eggs.
- iv. There is no black spot or ring on the dorsal fin.
- v. In case of female the genital opening is located between the anus and the base of the anal fin, but is more close to the anal fin.
- vi. The urinogenital papilla is a rounded fleshy mass with a longitudinal slit at its middle.
- vii. During the breeding season the genital papilla looks red in colour.

#### **4.2.11 Conditioning of brood fishes**

Generally six to eight hours before induced breeding the brood fishes were collected usually in the afternoon. The ripe males and females were acclimatized to the ground water in the holding tank before putting them into spawning tank. The fishes were kept into cemented cistern with hatchery water and all the time showering was continued. The males and females were conditioned in separate tank. In this way the fishes were kept to adjust themselves with new environment to increase their ability of endurance.

#### **4.2.12 Formation of set of breeders**

Just prior to injection of the PG the breeders were caught out of the cistern by a hand net and sets of breeders were formed. Usually a set was formed by one male and one female of same species of nearly equal body weight. In some experiments more than one male was introduced inside the cistern to equalize the weight of their patterns. But in no experiment more than one female was used.

#### 4.2.13 Experimental design

Prior to actual experimentation a number of range finding test were conducted to set the range of PG dose to be used in actual experiment. It was observed that fishes did not respond below the dose 10.00 mg/kg body weight (1<sup>st</sup> injection 5.00 mg/kg body weight and 2<sup>nd</sup> injection 5.00 mg/kg body weight). Therefore, to be safe 15 mg/kg body weight was taken as the lower limit of PG doses to be injected in actual experimental trail.

In the present investigation a number of PG doses were used and each desired experiment was administered in a double injection. In this case a particular dose to be applied to fish was divided into two as primary dose and secondary dose. The purpose of experiment was to find out a dose for *Clarias batrachus* which yields optimum results or best response. On the basis of the results obtained from range finding tests five different doses of pituitary gland extract were selected (dose D<sub>1</sub>, D<sub>2</sub>, D<sub>3</sub>, D<sub>4</sub> and D<sub>5</sub>). Pituitary gland extracts were selected for male and female fishes of *C. batrachus*. Each treatment (dose) had 3 replications i.e. each dose was applied to 3 individual fishes. The male and female ratio was 1:1 for *C. batrachus* and the weight of brood fish (both male and female) was in between 120-150 g. The experimental trials were repeated in different months of the breeding season, viz. April, May, June and July of 2010 and 2011 with a view to find out a specific dose for a specific months (Table 4.2).

**Table 4.2.** Spawning details of PG doses for *C. batrachus* in different breeding months of the year, 2010 and 2011.

Name of doses	Amount in 1 <sup>st</sup> injection (mg/kg)	Amount of 2 <sup>nd</sup> injection (mg/kg)	Total dose (mg/kg)
D <sub>1</sub>	05.00	10.00	15.00
D <sub>2</sub>	10.00	15.00	25.00
D <sub>3</sub>	10.00	20.00	30.00
D <sub>4</sub>	15.00	20.00	35.00
D <sub>5</sub>	15.00	30.00	45.00

In case of HCG it was observed that fishes did not respond below the dose 1 i.u. / 100 g body weight. So for better result 1 i.u/ 100 g body weight was taken as the lower limit of HCG doses to be injected in actual experimental trial.

In the present investigation a number of HCG doses were also used and each desired dose was administered in a single injection. Five different doses (dose D<sub>1</sub>, D<sub>2</sub>, D<sub>3</sub>, D<sub>4</sub> and D<sub>5</sub>) of human chorionic gonadotropin hormone were selected. On the basis of the results obtained from different doses it was tried to find out a dose for *C. batrachus* which yields optimum results or best response. Human chorionic gonadotropin hormone was selected for male and female fishes of *C. batrachus*. Each treatment (dose) had also 3 replications i.e. each dose was applied to 3 individual fishes. The male and female ratio was 1 : 1 for *C. batrachus* and the weight of brood fishes (both male and female) was also in between 120-150 g. The experimental trials were also repeated in different months of the breeding season, viz. April, May, June and July of 2010 and 2011 with a view to finding out a specific dose for specific months (Table 4.3).

**Table 4.3.** Spawning details of HCG doses for *C. batrachus* in different breeding months of the year, 2010 and 2011.

Name of doses	Amount of injection (i.u./100g)
D <sub>1</sub>	1.00
D <sub>2</sub>	2.00
D <sub>3</sub>	3.00
D <sub>4</sub>	4.00
D <sub>5</sub>	5.00

#### 4.2.14 Source of pituitary gland (PG) and human chorionic gonadotropin (HCG) hormone

Carp pituitary gland (PG) extracts and human chorionic gonadotropin (HCG) hormones were used for inducing the fishes for breeding. The PG and HCG

hormones (Sumacch, Infar Pharmaceutical Industries) were procured from local market and the consignment was new. The gland (PG) came in liquid (alcohol) preservatives. Preservation of fish pituitary gland in absolute alcohol was preferred because the alcohol preserved gland can even be stored at room temperature. The HCG was powder like in a vial and was stored in refrigerator.

#### **4.2.15 Preparation of PG extract and HCG solution**

To prepare the extract of PG for injection a required amount of PG was carefully weighted out by an analytical balance. The amount to be weighted out was calculated on the basis of total body weight of all the fishes of a particular treatment to be injected on a particular day, using the well established formula :

weight (mg) of PG (w) =  $\frac{Wb \times Pt}{100}$ , where, Wb represent total of the body

weight of all the fishes, to be injected and Pt represents the rate of mg of PG to be injected per 100g body weight under a particular treatment. The total volume of extract to be prepared was calculated by using the well established formula Vol. of extracts (ml) =  $Wt \times 0.5$ , where 0.5 represents the volume of the extract in milliliter to be injected per kilogram body weight. The weighted PG was homogenized with small amount of distilled water and that was carefully transferred to a centrifuge tube. The clear supernatants was transferred to a vial and made to predetermined volume with distilled water.

The HCG solution was prepared by homogenizing it in a tissue homogenizer and carefully centrifuged by a centrifuge machine. The upper clear fluid was used for injection purpose. The solution was prepared in such a way that a 100 g fish should not be administered with more than 0.5 ml HCG solution (Plate 4.1)



(a)



(b)

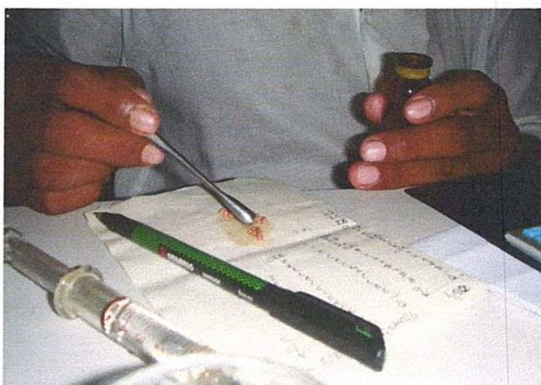

(c)



(d)



(e)



(f)

**Plate 4.1.** (a) Apparatus and equipments for injection for induced breeding  
(b) Preservation of PG glands in jars  
(c) Counting of PG glands  
(d) Grinding of PG for injection  
(e) PG solution and  
(f) Preserved HCG in vials or amples.

#### **4.2.16 Method of injection**

Just prior to injection, the breeders were taken out of cemented cistern by a net and the weight of the selected male and female were taken in g by a pan balance. The fishes were wrapped by wet, soft cloth then the broods were placed for injection. The amount of dose was determined on the basis of the body weight of the broods. The broods were injected intramuscularly at the base of the pectoral fin. In this experiment inducing the fish by PG the first injection was given to both the males and females but the second injection was given only to the females. The second injection was given after six hours of the first injection.

But inducing the fish by HCG in this case all the experimental females were given a single injection and the male fishes were also given HCG injection as a single dose during injection of the female fish (Plate 4.2 and Plate 4.3).

#### **4.2.17 Mode of injection**

Intramuscular injection into the dorsal muscles above the lateral line below the anterior part of the dorsal fin is the commonly used technique. The placement of needle for injection was important and its angle to the base of pectoral fin was recommended as 35°-60° and also the depth of the pushing injection was recommended as 1 to 1.5 cm. While injecting the fishes, one person pressed the head and tail of the breeder against the ground. The second person inserted the needle in the soft region at the base of pectoral fin. Second injection was given in the opposite side of the body where the first injection was administered. This can be done using a graduated syringe ranging from 2 to 5 ml.

#### **4.2.18 Post injection procedure**

After pushing the injections, the male and female brood fishes were placed again in the breeding cistern and water was supplied by shower bath of the tanks, which had inlet and outlet system of water circulation. Then the responses were observed. At this time the breeders showed tremendous



spawning behaviour. Spawning activity of the fishes was observed to start around 12 to 14 hours after the injection of pituitary extract or human chorionic gonadotropin hormone. Until apparently the impulse to mate did not occur, males and females just rested at the bottom of breeding cistern in a standstill position carefully avoiding the lighted zone. From time to time they hurriedly negotiated the water column and came to surface to gulp air. The impulse to mate manifested by apparent restlessness and they started moving around displaying action like chasing or nudging each other with their snouts. Often their snout to snout collision made a feeble thud audible. Generally, females took the lead in mating behaviour and induced the males to participate by nudging with their its snout at their genital region. Now they are ready for spawning. Some males and females responded and they released their eggs and spermatozoa.

#### **4.2.19 Spawning and fertilization**

In the present experiment stripping method was applied. Stripping was carried out within 14 hours after administration of second injection in female. In case of HCG dose application the latency period of 18 hours was allowed after which the female fishes were stripped for eggs. The male fishes were injected and the testes were collected and cut into several pieces with sharp blade and pressed gently by a cloth to collect the milt. The milt was kept in water glass supplemented with 5% dextrose + 3% saline water. Then the eggs and milt solution were mixed thoroughly in a plastic bowl with gentle shake for five minutes (Plate 4.4 and Plate 4.5).

Sperms were then allowed to remain with eggs for another five minutes and excess sperms were removed washing with water. The fertilised eggs were then placed in hatching bed (made of nylon cloth) and submerged in a tray with a continuous water flow. The water temperature of the tray ranged between 27-28°C during the experiment. After spawning the brood fishes were removed immediately from the breeding cistern.



(a)



(b)



(c)

**Plate 4.2.** Adult brood fish (*Clarias batrachus*) and weighing of the brood fishes.



(a)



(b)

**Plate 4.3.** Injection procedure of *Clarias batrachus*.



**Plate 4.4.** Stripping of female *C. batrachus*.



(a)



(b)



(c)

**Plate 4.5.** Showing the dissection of testes of male *C. batrachus*.

#### **4.2.20 Incubation and hatching of fertilized eggs**

Fertilized eggs were incubated in running water on the hatching bed which was made of nylon cloth and submerged in a tray. The trays were filled with clean well-oxygenated water, free from planktonic organisms. The eggs were spread homogenously in one single layer in the incubation tray. These trays were made in such a way that the eggs were continuously oxygenated by water current. Therefore incubation was carried out promptly after fertilization.

Fertilization and hatching were calculated for all these experiments. For fertilization assay, few fertilized eggs were placed in a watch glass. The percentage of eggs fertilized was judged 2 hours after insemination, using a compound microscope. The unfertilized eggs could easily be identified by their whitish opaque colour showed clear signs of developmental stages. The fertilized eggs were bright and shining whereas the unfertilized eggs were opaque and drab. The number of fertilized and unfertilized eggs were recorded. Similarly upon completion of hatching the percentage of hatching was also counted and recorded.

#### **4.2.21 Spawn rearing and assessment of survivability**

Rearing of magur spawn was carried out in a aluminium tray (160 cm × 70 cm × 10 cm water depth) facilitated with continuous water flow for 7 days after hatching under a shade. Few PVC pipe were placed on tray as shelter. After 4 days of hatching when the yolk sac was partly absorbed, the spawns were fed with egg yolk and powder milk at 4<sup>th</sup> interval for 3 days. Fecal wastage and dead larvae were removed before feeding. 7 days after, the fry were counted and survivability was estimated.

#### 4.2.22 Indices for assessing the effectiveness of different PG and HCG doses

The following parameters were taken as indices to evaluate the effectiveness of different PG and HCG doses.

- i. The percentage of ovulation was calculated by the formula:

$$\text{percent ovulation} = \frac{\text{No. of fish ovulated}}{\text{Total no. of fish injected}} \times 100$$

- ii. The fertilization rate was calculated by using formula:

$$\text{percent fertilization} = \frac{\text{No. of fertilized eggs}}{\text{Total number of eggs (fertilized + unfertilized)}} \times 100$$

- iii. The hatching percentage was calculated as:

$$\text{percent hatching} = \frac{\text{No. of spawn obtained}}{\text{No. of fertilized eggs}} \times 100$$

- iv. The survival percentage was estimated :

$$\text{percent survivability} = \frac{\text{No. of fry obtained}}{\text{No. of spawn}} \times 100$$

#### 4.2.23 Analysis of data

The data were initially processed by computer program MS Excel, percentage data were then transformed. One way analysis of variance (ANOVA) was employed to assess the treatment effect of different PG and HCG doses.

### 4.3 Results and observations

The results of induced breeding were obtained through 5 breeding experiments using 5 different doses of PG and HCG. The results documente here demonstrated the effect of PG and HCG doses on egg releases, fertilization, hatching rates of eggs and survivability of *Clarias batrachus*.

One way analysis of variance (ANOVA) on ovulation response (egg release), fertilization, hatching and survivability found a significant difference ( $p < 0.01$ ) among the treatments of different doses for PG and HCG in *Clarias batrachus* (Appendix Table 7-22). Most of the cases it was found that the results are

significant among the treatments of different doses for PG and HCG in *C. batrachus*. In some cases the relation is very significant and insignificant results are also found in a very few cases.

#### **4.3.1 Effect of different PG doses in different months for the breeding of *Clarias batrachus***

Five different doses of PG i.e. D<sub>1</sub>, D<sub>2</sub>, D<sub>3</sub>, D<sub>4</sub> and D<sub>5</sub> were applied to induce the fish. The results of the experiments are as follows:

##### **(a) PG doses in April**

###### **Percentage of egg release**

On studying the different parameters of experiment it was observed that in the month of April the dose (D<sub>1</sub>) of 15 mg/kg body weight (1<sup>st</sup> injection 05 mg/kg body weight and 2<sup>nd</sup> injection 10 mg/kg body weight) did not induce the fishes for egg release. The dose (D<sub>2</sub>) of 25 mg/kg body weight (1<sup>st</sup> injection 10 mg/kg body weight and 2<sup>nd</sup> injection 15 mg/kg body weight) induced the fishes to release the eggs at the rate of 16.67%. On the other hand the 100% egg release response result was recorded by applying the dose (D<sub>3</sub>) 30 mg/kg body weight and other doses above (D<sub>4</sub> and D<sub>5</sub>) of 35 mg/kg and 45 mg/kg body weight.

###### **Percentage of fertilization**

It was observed that fertilization rates varied between 10.14% to 83.99% being highest (83.99%) in the fish injected with PG dose (D<sub>4</sub>) 35 mg/kg body weight (1<sup>st</sup> injection 15 mg/kg of body weight and 2<sup>nd</sup> injection 20 mg/kg body weight). The other doses (D<sub>2</sub>, D<sub>3</sub> and D<sub>5</sub>) of 25 mg/kg, 30 mg/kg and 45 mg/kg body weight resulted in lower fertilization, which were 10.14%, 73.79 and 72.31 respectively.

###### **Percentage of hatching**

The hatching rate was in between 9.05% to 80.19% with the highest (80.19%) at the same dose (D<sub>4</sub>) of 35 mg/kg body weight and lowest at the dose of (D<sub>2</sub>) 25 mg/kg body weight. 67.69% and 65.09% hatching rates were observed at the doses (D<sub>3</sub>) of 30 mg/kg and (D<sub>5</sub>) of 45 mg/kg body weight.



**Percentage of survivability**

The survival rate was observed in between 12.05% to 81.63%. It was noted that the highest survival rate was found at the dose (D<sub>4</sub>) of 35 mg/kg body weight (1<sup>st</sup> injection 15 mg/kg body weight and 2<sup>nd</sup> injection 20 mg/kg body weight). The lowest survival rate was found in the fish treated with PG dose of (D<sub>2</sub>) 25 mg/kg body weight (1<sup>st</sup> injection of 10 mg/kg body weight and 2<sup>nd</sup> injection 15 mg/kg body weight). The dose (D<sub>3</sub>) of 30 mg/kg body weight and dose (D<sub>5</sub>) of 45 mg/kg body weight resulted in 73.69% and 75.50% fertilization rate (Table 4.4 and Fig. 4.1).

**(b) PG doses in May****Percentage of egg release**

The percentage of ovulation response of the fishes varied in between 33.33% to 100% in the month of May. The lowest percentage 33.33% was at the dose (D<sub>1</sub>) of 15 mg/kg body weight. The PG dose (D<sub>2</sub>) of 25 mg/kg body resulted in 66.66% fertilization. PG doses (D<sub>3</sub>) of 30 mg/kg body weight (1<sup>st</sup> injection 10 mg/kg and 2<sup>nd</sup> injection 20 mg/kg body weight) and above resulted in 100% egg release response.

**Percentage of fertilization**

Fertilization rates varied between 8.90% to 86.41% being higher (86.41%) in the fish treated with PG dose (D<sub>4</sub>) 35 mg/kg body weight (1<sup>st</sup> injection 15 mg/kg body weight and 2<sup>nd</sup> injection of 20 mg/kg body weight). The lowest fertilization rate was 8.90% in the fish treated with PG dose (D<sub>1</sub>) 15 mg/kg body weight (1<sup>st</sup> injection 5 mg/kg and 2<sup>nd</sup> injection 10 mg/kg of body weight). The other fertilization rates 41.04%, 75.28% and 72.70% were observed in the fishes treated with PG doses (D<sub>2</sub>, D<sub>3</sub> and D<sub>5</sub>) of 25 mg/kg, 30 mg/kg and 45 mg/kg body weight respectively.

**Percentage of hatching**

The hatching rate was observed in between 5.95% and 81.45%. The highest 81.45% was found at the dose (D<sub>4</sub>) of 35 mg/kg body weight (1<sup>st</sup> dose 15 mg/kg body weight and 2<sup>nd</sup> dose 20 mg/kg body weight). The lowest hatching rate 5.95% was observed in the fishes treated with PG dose (D<sub>1</sub>) 15 mg/kg body weight (1<sup>st</sup> injection 5 mg/kg of body weight and 2<sup>nd</sup> injection 10 mg/kg body weight). The other doses (D<sub>2</sub>, D<sub>3</sub> and D<sub>5</sub>) of 25 mg/kg body weight, 30 mg/kg body weight and 45 mg/kg body weight resulted in 36.08%, 69.39% and 63.47% hatching rates.

**Percentage of survivability**

The survival rate ranged from 22.84% to 82.72%. The highest 82.72% rate was found at the dose (D<sub>4</sub>) of 35 mg/kg body weight (1<sup>st</sup> injection 15 mg/kg body weight and 2<sup>nd</sup> injection 20 mg/kg body weight). The lowest survival rate 22.84% was found in the fishes treated with the PG dose (D<sub>1</sub>) of 15 mg/kg body weight (1<sup>st</sup> injection 5 mg/kg body weight and 2<sup>nd</sup> injection 10 mg/kg body weight). 47.84%, 75.50% and 74.50% survival rates were found in the doses (D<sub>2</sub>, D<sub>3</sub> and D<sub>5</sub>) of 25 mg/kg, 30 mg/kg and 45 mg/kg body weight respectively (Table 4.4 and Fig. 4.2).

**(c) PG doses in June****Percentage of egg release**

During the moth of June it was found that the ovulation response varied in between 66.66% to 100.00%. The PG dose (D<sub>2</sub>) of 25 mg/kg body weight and the above doses (D<sub>3</sub>, D<sub>4</sub> and D<sub>5</sub>) were responsible for the 100% egg release response. The lower egg release response 66.66% was found when the fishes were injected with PG dose (D<sub>1</sub>) of 15 mg/kg body weight (1<sup>st</sup> injection 5 mg/kg and 2<sup>nd</sup> injection 10 mg/kg body weight).

**Percentage of fertilization**

The fertilization rate varied in between 18.74% to 86.96%. The highest was 86.96% due to the PG dose (D<sub>4</sub>) of 35 mg/kg body weight. The lowest 18.74% was found when the fishes were treated with PG dose (D<sub>1</sub>) of 15 mg/kg body weight (1<sup>st</sup> injection 5 mg/kg and 2<sup>nd</sup> injection 10 mg/kg body weight). The fishes injected with PG doses (D<sub>2</sub>, D<sub>3</sub> and D<sub>4</sub>) of 25 mg/kg, 30 mg/kg and 45 mg/kg body weight resulted in 64.44%, 77.18% and 74.56% of fertilization rate respectively.

**Percentage of hatching**

The hatching rate varied in between 12.28% to 81.84%. The highest 81.14% hatching rate was found at the PG dose (D<sub>4</sub>) of 35 mg/kg body weight (1<sup>st</sup> dose 15 mg/kg body weight and 2<sup>nd</sup> dose 20 mg/kg body weight). The lowest was 12.28% at the PG dose (D<sub>1</sub>) of 15 mg/kg body weight. 55.81%, 69.85% and 65.72% of hatching rates were found in the PG doses (D<sub>2</sub>, D<sub>3</sub> and D<sub>5</sub>) of 25 mg/kg, 30 mg/kg and 45 mg/kg body weight respectively.

**Percentage of survivability**

In case of survival rate the highest 83.77% was observed at the PG dose (D<sub>4</sub>) of 35 mg/kg body weight (1<sup>st</sup> injection 15 mg/kg body weight and 2<sup>nd</sup> injection 20 mg/kg body weight). The lowest survival rate was 45.62% at the PG dose (D<sub>1</sub>) of 15 mg/kg body weight. The other PG doses (D<sub>2</sub>, D<sub>3</sub> and D<sub>5</sub>) of 25 mg/kg, 30 mg/kg and 45 mg/kg body weight resulted in lower fertilization rate than the PG dose (D<sub>4</sub>) (Table 4.4 and Fig. 4.3).

**(d) PG doses in July****Percentage of egg release**

During the month of July it was observed that the egg release response was distinctly influenced by different PG doses. The PG dose (D<sub>1</sub>) of 15 mg/kg body weight and dose (D<sub>2</sub>) of 25 mg/kg body weight showed the lower rate (66.66%) of egg release response. Simultaneously the PG dose (D<sub>3</sub>) of 30 mg/kg, dose (D<sub>4</sub>) 35 mg/kg and dose (D<sub>5</sub>) of 45 mg/kg body weight showed 100% egg release response.

**Percentage of fertilization**

Different PG doses highly influenced the fertilization rate also. The highest fertilization rate 84.71% was found at the PG dose (D<sub>4</sub>) of 35 mg/kg body weight (1<sup>st</sup> injection 15 mg/kg body weight and 2<sup>nd</sup> injection 20 mg/kg body weight) and the lowest 17.84% was observed at the PG dose (D<sub>1</sub>) of 15 mg/kg body weight. The doses (D<sub>2</sub>, D<sub>3</sub> and D<sub>5</sub>) of 25, 30 and 45 mg/kg body weight respectively showed the lower fertilization rate than the result of PG dose (D<sub>4</sub>).

**Percentage of hatching**

The hatching rate varied in between 11.82% to 78.86%. It was observed that the highest was at the PG dose (D<sub>4</sub>) of 35 mg/kg body weight and the lowest was at the PG dose (D<sub>1</sub>) of 15 mg/kg body weight. The 43.56%, 68.20% and 62.35% of hatching rates were also observed at the PG doses (D<sub>2</sub>, D<sub>3</sub> and D<sub>5</sub>) of 25 mg/kg, 30 mg/kg and 45 mg/kg body weight respectively.

**Percentage of survivability**

It was found that the survival rate ranged from 45.21% to 80.72%. The highest rate 80.72% was observed when the fishes were injected with the dose (D<sub>4</sub>) of 35 mg/kg body weight (1<sup>st</sup> dose 15 mg/kg body weight and 2<sup>nd</sup> dose 20 mg/kg body weight). The lowest survival rate 45.21% was found in the fishes treated with PG dose (D<sub>1</sub>) of 15 mg/kg body weight (1<sup>st</sup> injection 5 mg/kg body weight and 2<sup>nd</sup> injection 10 mg/kg body weight). The other PG doses (D<sub>2</sub>, D<sub>3</sub> and D<sub>5</sub>) of 25 mg/kg, 30 mg/kg and 45 mg/kg body weight resulted in 57.67%, 73.40% and 73.10% of survival rate respectively (Table 4.4 and Fig. 4.4).

**Table 4.4.** Effect of different doses of PG on egg release response, fertilization, hatching rate and survivability of *Clarias batrachus* in different months during the years of 2010 and 2011 (values are arithmetic mean).

Months	Doses	% of egg release response	% of fertilization	% of hatching	% of survivability
April	D <sub>1</sub>	00.00	00.00	00.00	00.00
	D <sub>2</sub>	16.67	10.14	9.05	12.05
	D <sub>3</sub>	100.00	73.79	67.69	73.69
	D <sub>4</sub>	100.00	83.99	80.19	81.63
	D <sub>5</sub>	100.00	72.31	65.09	75.50
May	D <sub>1</sub>	33.33	8.90	5.95	22.84
	D <sub>2</sub>	66.66	41.04	36.08	47.84
	D <sub>3</sub>	100.00	75.28	69.39	75.50
	D <sub>4</sub>	100.00	86.41	81.45	82.72
	D <sub>5</sub>	100.00	72.70	63.47	74.50
June	D <sub>1</sub>	66.66	18.74	12.28	45.62
	D <sub>2</sub>	100.00	64.44	55.81	71.93
	D <sub>3</sub>	100.00	77.18	69.85	76.29
	D <sub>4</sub>	100.00	86.96	81.84	83.77
	D <sub>5</sub>	100.00	74.56	65.72	72.58
July	D <sub>1</sub>	66.66	17.84	11.82	45.21
	D <sub>2</sub>	66.66	53.47	43.56	57.67
	D <sub>3</sub>	100.00	77.82	68.20	73.40
	D <sub>4</sub>	100.00	84.71	78.86	80.72
	D <sub>5</sub>	100.00	70.69	62.35	73.10

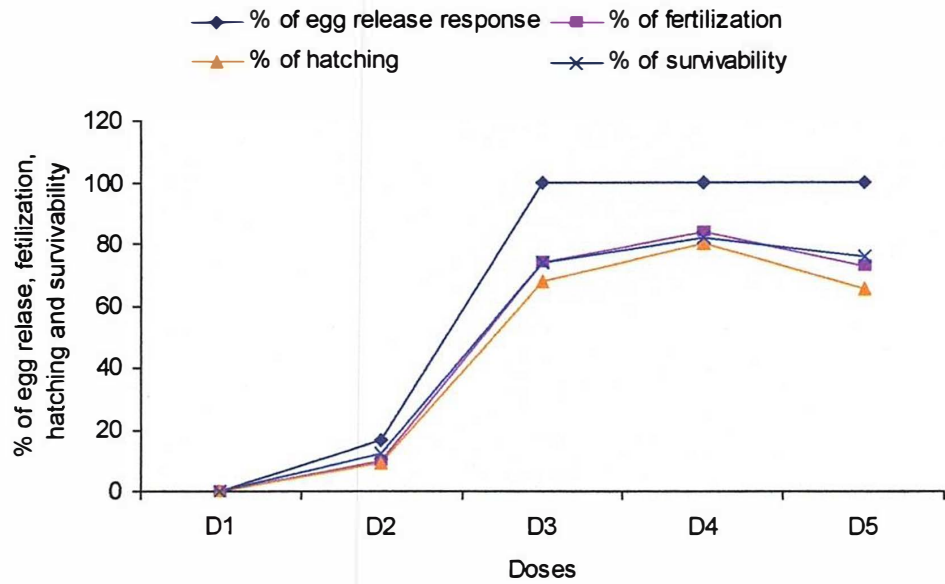

**Fig. 4.1.** Showing the comparative mean value of egg release, fertilization, hatching and survivability of *C. batrachus* using different doses of PG in the month of April (2010 and 2011).

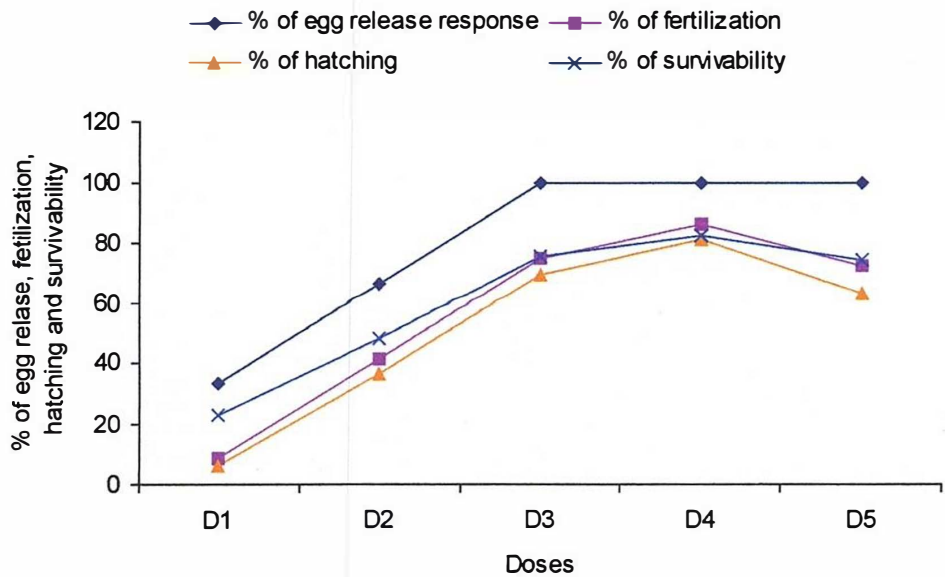

**Fig. 4.2.** Showing the comparative mean value of egg release, fertilization, hatching and survivability of *C. batrachus* using different doses of PG in the month of May (2010 and 2011).

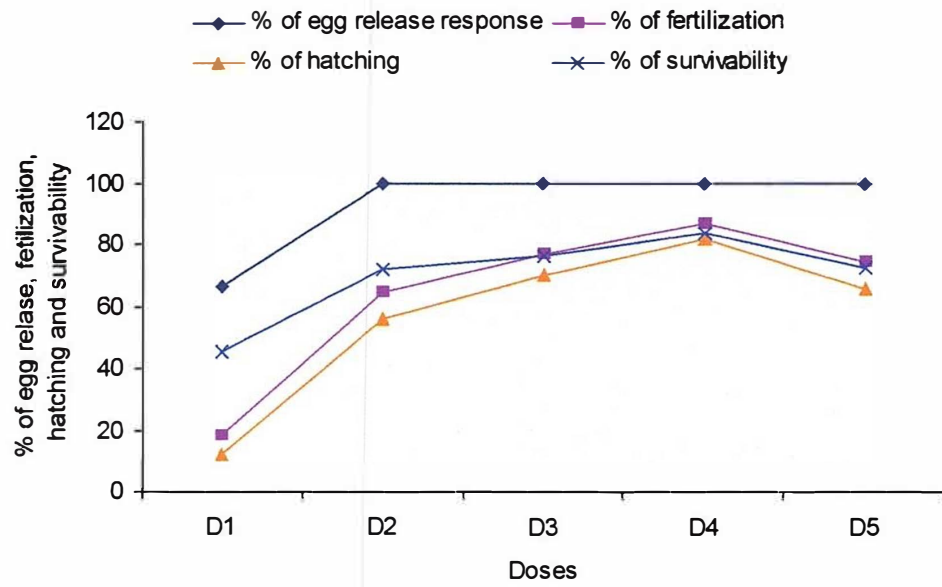

**Fig. 4.3.** Showing the comparative mean value of egg release, fertilization, hatching and survivability of *C. batrachus* using different doses of PG in the month of June (2010 and 2011).

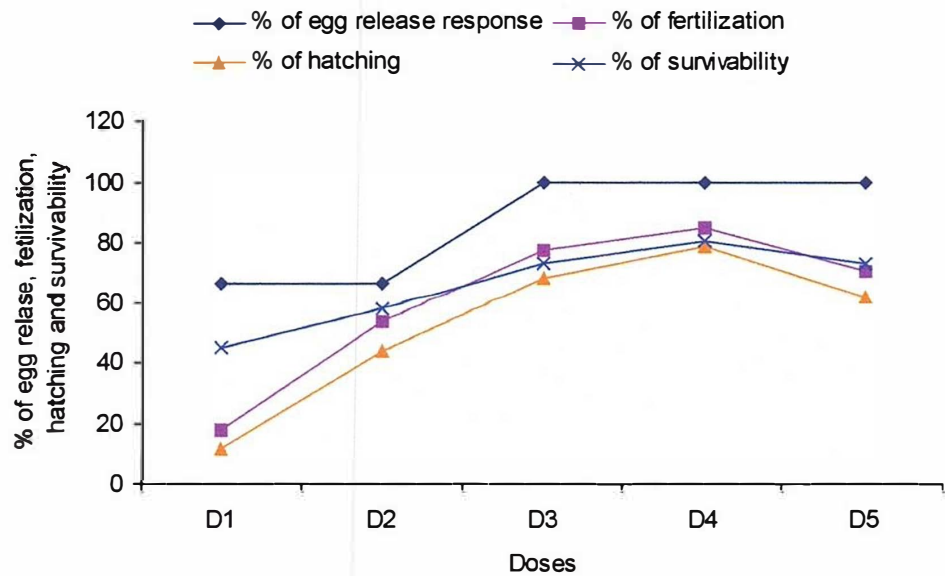

**Fig. 4.4.** Showing the comparative mean value of egg release, fertilization, hatching and survivability of *C. batrachus* using different doses of PG in the month of July (2010 and 2011).

### **4.3.2 Effect of different HCG doses in different months for the breeding of *Clarias batrachus***

Five different doses of HCG (Human chorionic gonadotropin) i.e, the dose D<sub>1</sub>, D<sub>2</sub>, D<sub>3</sub>, D<sub>4</sub> and D<sub>5</sub> were applied to induce the fish *C. batrachus*. The results regarding egg release, fertilization, hatching and survivability of the fishes were recorded, that the result is shown below:

#### **a) HCG doses in April**

##### **Percentage of egg release**

On studying the different parameters of experiments it was observed that in the month of April the egg release percentage varied from 33.33% to 100.00%. The highest percentage 100.00% was observed by applying the doses D<sub>3</sub> and D<sub>4</sub> at the rate of 3 i.u/100 g and 4 i.u/100g body weight of the fish and the lowest percentage of 33.33% was found by the dose D<sub>2</sub> at the rate of 2 i.u/100g body weight of fish. The dose D<sub>5</sub> at the rate of 5 i.u/100g body weight of fish resulted 50% egg release. The dose D<sub>1</sub> at the rate of 1 i.u/100g body weight of fish did not ovulate the fishes for egg release.

##### **Percentage of fertilization**

During the experiment it was observed that in the month of April the fertilization rate varied 13.04% to 81.18%. The highest and the lowest percentage of fertilization 81.8% and 13.04% were observed by applying the doses D<sub>3</sub> and D<sub>2</sub> at the rate of 3 i.u/100g and 2 i.u/100g body weight of fishes respectively. The dose D<sub>4</sub> (4 i.u/100g body weight of fish) and D<sub>5</sub> (5 i.u/100 g body weight of fish) resulted 75.3% and 34.52% fertilization.

##### **Percentage of hatching**

The hatching rate was observed in between 12.29% to 75.82%, during the month of April. The highest rate was obtained by the dose of D<sub>3</sub> and lowest was obtained by D<sub>2</sub> at the rate of 3 i.u/100 g and 2 i.u/100 g body weight of fish respectively. 64.77% and 27.19% hatching rates were found with the doses of D<sub>4</sub> (4 i.u/100 g body weight of fish) and D<sub>5</sub> (5 i.u/100 g body weight of fish).



**Percentage of survivability**

During the month of April the highest survival rate 77.25% was marked by the dose of D<sub>3</sub> (at the rate of 3 i.u/100 g body weight) and lowest survival rate 21.48% was found in dose D<sub>2</sub> (at rate of 2 i.u/100 g body weight). The other doses D<sub>4</sub> and D<sub>5</sub> resulted 71.93% and 33.38% survivability of fishes (Table 4.5 and Fig. 4.5).

**b) HCG doses in May****Percentage of egg release**

The percentage of ovulation response of the fish varied in between 50% to 100% treated with HCG doses in the month of May. The lowest percentage of ovulation 50% was at the dose (D<sub>2</sub>) of 2 i.u/100 g body weight of fish. HCG doses (D<sub>3</sub>) of 3 i.u/100 g body weight and above (D<sub>4</sub> and D<sub>5</sub> at the rate of 4 i.u and 5 i.u/100 g body weight) resulted in 100% egg release response. Egg release response was 0% at the dose of A (1 i.u/100 g body weight).

**Percentage of fertilization**

Fertilization rates varied from 19.79% to 81.71% being higher (81.71%) in the fish treated with HCG dose (D<sub>3</sub>) of 3 i.u/100 g body weight. The lowest fertilization rate was 19.79% in the fish treated with HCG dose (D<sub>2</sub>) of 2 i.u/100 g body weight of fish. After the highest 75.80% and 68.89% fertilization rates were found in dose of D<sub>4</sub> (4 i.u/100 g body weight) and D<sub>5</sub> (5 i.u/100 g body weight).

**Percentage of hatching**

The hatching rate was observed in between 18.56% to 75.75%. The highest 75.75% was found at the dose of D<sub>3</sub> (3 i.u/100 g body weight of fish). The lowest hatching rate 18.56% was observed in the fish treated with dose of D<sub>2</sub> (2 i.u/100 g body weight). The doses D<sub>4</sub> (4 i.u/100 g body weight) and D<sub>5</sub> (5 i.u/100 g body weight) resulted in 65.93% and 53.48% hatching respectively at this experiment.

**Percentage of survivability**

The survival rate ranged in between 31.09% to 78.82%. The highest rate 78.82% was found at the dose of D<sub>3</sub> (3 i.u/100 g body weight). The lowest survival rate 31.09% was found at the dose of D<sub>2</sub> (2 i.u/100 g body weight). 74.22% and 67.98% survivability were found at the dose of D<sub>4</sub> (4 i.u/100 g body weight) and D<sub>5</sub> (5 i.u/100 g body weight) during the experiment (Table 4.5 and Fig. 4.6).

**C) HCG doses in June****Percentage of Egg release**

During the month of June it was found that the ovulation response was in between 66.66% and 100%. The lowest was 66.66% which was found in dose D<sub>2</sub> at the rate of 2 i.u/100 g body weight. 100% ovulation was found in the doses of D<sub>3</sub>, D<sub>4</sub> and D<sub>5</sub> at the rate of 3 i.u/100 g, 4 i.u/100 g and 5 i.u/100 g body weight of fishes. The dose D<sub>1</sub> at the rate of 1 i.u/100 g body weight showed no ovulation response.

**Percentage of fertilization**

Different HCG doses highly influenced the fertilization rate. The highest fertilization rate 83.9% was found at HCG dose D<sub>3</sub> of 3 i.u/100 g body weight. The other doses of HCG like D<sub>2</sub>, D<sub>4</sub> and D<sub>5</sub> of 2 i.u, 4 i.u and 5 i.u/100 g body weight showed the lower fertilization rate i.e. 27.65%, 74.31% and 69.13%.

**Percentage of hatching**

The hatching rate varied from 23.81% to 76.42% during the month of June. In the experiment the highest hatching rate 76.42% was found in the dose D<sub>3</sub> at the rate of 3 i.u/100 g body weight. The lowest rate 23.81% was observed in the dose D<sub>2</sub> at the rate of 2 i.u/100 g body weight. 66.78% and 55.33% hatching rates were observed in the doses D<sub>4</sub> and D<sub>5</sub> at the rate of 4 i.u/100 g and 5 i.u/100 g body weight of fishes respectively.

### **Percentage of survivability**

It was also found that the survival rate ranged in between 41.37% to 75.71% in the experiment. The highest rate 75.71% was observed by applying the HCG dose  $D_3$  at the rate of 3 i.u./100 g body weight. The lowest rate 41.37% was found in dose  $D_2$  at the rate of 2 i.u./100 g body weight. The doses  $D_4$  and  $D_5$  at the rate of 4 i.u./100 g and 5 i.u./100 g body weight showed the lower survival rate 72.95% and 67.96% than the dose of  $D_3$  (Table 4.5 and Fig. 4.7).

### **d) HCG doses in July**

In the month of July it was observed that the egg release response, fertilization hatching and survival rate were distinctly influenced by different HCG doses.

### **Percentage of egg release**

During the experiment the doses  $D_2$  and  $D_5$  at the rate of 2 i.u./100 g and 5 i.u./100 g body weight showed lower rate of egg release responses i.e, 50% and 66.66%. Whereas dose  $D_3$  and  $D_4$  at the rate of 3 i.u./100 g and 4 i.u./100 g body weight marked 100% egg release response in the experiment. The dose  $D_1$  the rate of 1 i.u./100 g body weight gave no egg release response.

### **Percentage of fertilization**

The fertilization rate varied from 20.15% to 80.82%. It was found that the highest 80.82% percentage rate was with the dose of  $D_3$  (3 i.u./100 g body weight) and the lowest 20.15% was at the dose of  $D_2$  (2 i.u./100 g body weight). 73.05% and 44.91% of hatching rates were found with the doses of  $D_4$  (4 i.u./100 g body weight) and  $D_5$  (5 i.u./100 g body weight).

### **Percentage of hatching**

The hatching rate varied in between 15.16% to 75.03% during the month of June. The highest 75.03% hatching rate was found at the HCG dose ( $D_3$ ) of 3 i.u./100 g body weight of fish and the lowest 15.16% hatching rate was obtained at the HCG dose ( $D_2$ ) of 2 i.u./100 g body weight of fish. The other doses of  $D_4$  (at the rate of 4 i.u./100 g body weight) and  $D_5$  (at the rate of 5 i.u./100 g body weight) resulted in 65.92% and 37.45% hatching rate which were lower than the percentage of dose  $D_3$ .

### Percentage of survivability

In case of survival rate the highest (76.02%) percentage was observed by applying the dose D<sub>3</sub> at the rate of 3 i.u/100 g body weight of fish and in same way the lowest (31.48%) percentage was found by applying the dose D<sub>2</sub> at the rate of 2 i.u/100 g body weight of fish. The doses D<sub>4</sub> and D<sub>5</sub> accounted for the percentage of survival rate 71.43% and 43.82% respectively (Table 4.5 and Fig. 4.8).

**Table 4.5.** Effect of different doses of HCG on egg release response, fertilization, hatching rate and survivability of *Clarias batrachus* in different months during the year of 2010 and 2011 (values are arithmetic mean).

Months	Doses	% of egg release response	% of fertilization	% of hatching	% of survivability
April	D <sub>1</sub>	00.00	00.00	00.00	00.00
	D <sub>2</sub>	33.33	13.04	12.29	21.48
	D <sub>3</sub>	100.00	81.18	75.82	77.25
	D <sub>4</sub>	100.00	75.30	64.77	71.93
	D <sub>5</sub>	50.00	35.52	27.19	33.98
May	D <sub>1</sub>	00.00	00.00	00.00	00.00
	D <sub>2</sub>	50.00	19.79	18.56	31.09
	D <sub>3</sub>	100.00	81.71	75.75	78.82
	D <sub>4</sub>	100.00	75.80	65.93	74.22
	D <sub>5</sub>	100.00	68.89	53.48	67.98
June	D <sub>1</sub>	00.00	00.00	00.00	00.00
	D <sub>2</sub>	66.66	27.65	23.81	41.37
	D <sub>3</sub>	100.00	83.90	76.42	75.71
	D <sub>4</sub>	100.00	74.31	66.78	72.95
	D <sub>5</sub>	100.00	69.13	55.33	67.96
July	D <sub>1</sub>	00.00	00.00	00.00	00.00
	D <sub>2</sub>	50.00	20.15	15.16	31.48
	D <sub>3</sub>	100.00	80.82	75.03	76.02
	D <sub>4</sub>	100.00	73.05	65.92	71.43
	D <sub>5</sub>	66.66	44.91	37.45	43.82

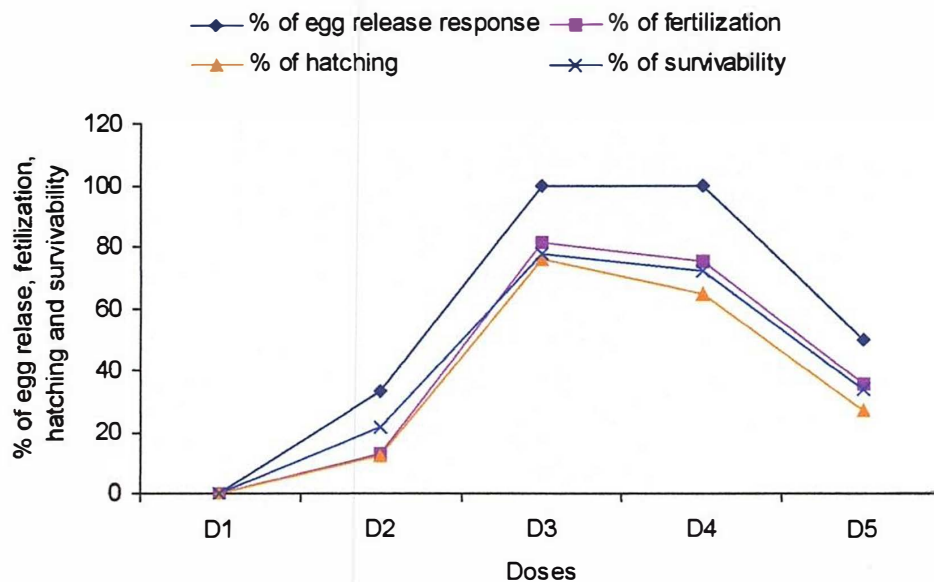

**Fig. 4.5.** Comparative mean value of egg release, fertilization, hatching and survivability of *C. batrachus* using different doses of HCG in the month of April (2010 and 2011).

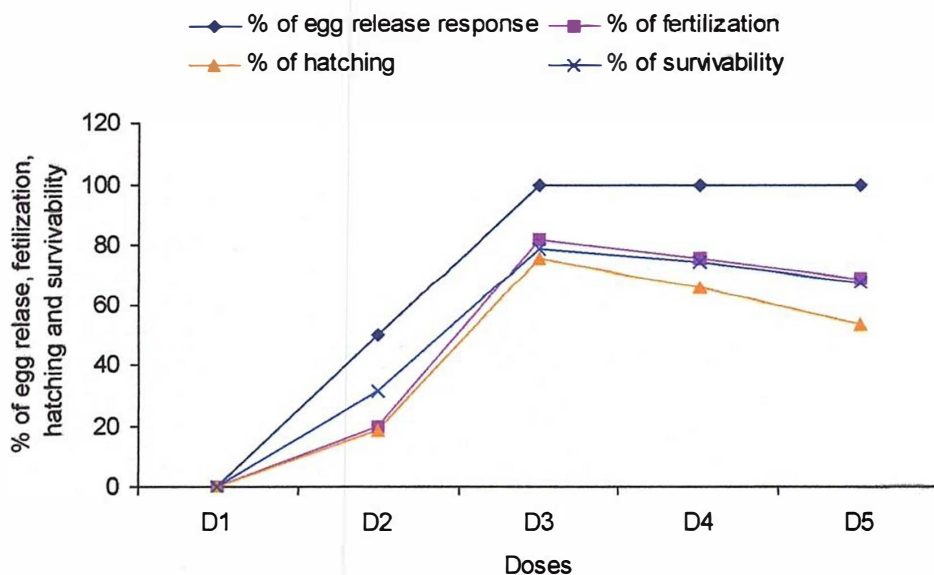

**Fig. 4.6.** Comparative mean value of egg release, fertilization, hatching and survivability of *C. batrachus* using different doses of HCG in the month of May (2010 and 2011).

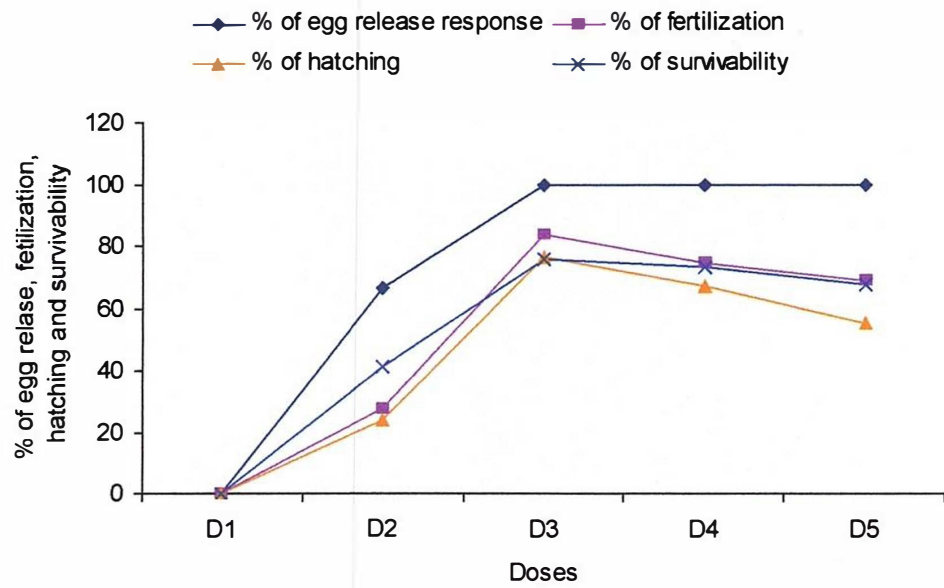

**Fig. 4.7.** Comparative mean value of egg release, fertilization, hatching and survivability of *C. batrachus* using different doses of HCG in the month of June (2010 and 2011).

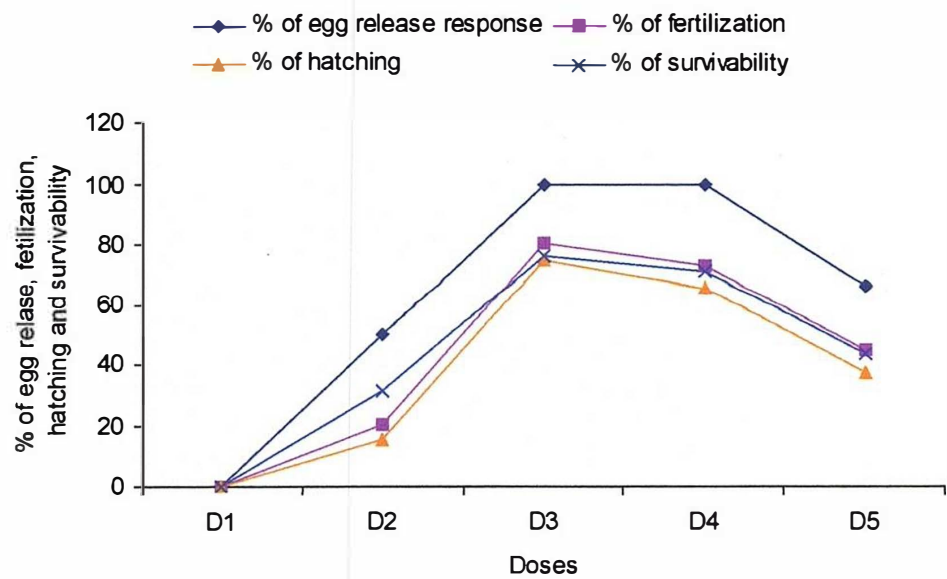

**Fig. 4.8.** Comparative mean value of egg release, fertilization, hatching and survivability of *C. batrachus* using different doses of HCG in the month of July (2010 and 2011).

#### 4.4 Discussion

In the present study pituitary gland (PG) extract and human chorionic gonadotropin (HCG) hormones were used as the inducing agents for breeding of *C. batrachus*. The effectiveness of these hormones PG and HCG in breeding of different teleost fishes specially in cat fish *C. batrachus* are discussed below:

##### 4.4.1 For PG doses

The PG was used in the experiment as it is cheap, easily available and used by most hatchery operators in Bangladesh. Fish pituitaries in general have been found to be most effective in artificial fish breeding practice (Chaudhury, 1969). Effectiveness of carp pituitary extract in artificial breeding of fishes have been supported by Harvey and Hoar (1979), Davy and Chouinard (1980), Rothbard (1981), Alam and Bhuiyan (1999), Sharma and Singh (2002) and Bhuiyan *et al.* (2008). It was therefore decided to use PG for induced breeding of the cat fish.

As stated in the results that PG dose (D<sub>1</sub>) of 15.00 mg/kg body weight (1<sup>st</sup> injection 5.00 mg/kg and 2<sup>nd</sup> injection 10.00 mg/kg body weight) and PG dose (D<sub>2</sub>) of 25.00 mg/kg body weight (1<sup>st</sup> injection 10.00 mg/kg and 2<sup>nd</sup> injection 15.00 mg/kg body weight) resulted in partial egg release response. PG doses (D<sub>3</sub>) of 30.00 mg/kg (1<sup>st</sup> injection 10.00 mg/kg and 2<sup>nd</sup> injection 20.00 mg/kg body weight) and above dose (D<sub>4</sub> and D<sub>5</sub>) resulted in a 100% ovulation response (Table-4.4).

Many authors made attempts to standardize the PG doses for breeding fishes. But there exists some ambiguities in the results reported by them and are also in variance with the findings of the present study. Thakur (1976) used 80 to 130 mg/kg body weight of PG to breed the fish *C. batrachus* and observed their spawning behaviour. Harvey and Hoar (1979), referred a total of 80-90 mg/kg body weight of Indian carp pituitaries for inducing the catfish, *Clarias batrachus*. Rahmatullah *et al.* (1983) suggested a first dose of 70-75 mg/kg body weight for both males and females and a second dose, just double the

1<sup>st</sup> dose of PG to induce the fish *C. batrachus*. In all the above cases it was found that the amount of PG doses used for inducing the fish was more than the present study ranging from 15-45 mg/kg body weight. But Hossain *et al.* (2006) reported that artificial breeding was successfully done in *C. batrachus* with PG 10.0 mg/kg body weight in first dose and 45.0 mg/kg body weight in second dose which is more or less similar to the most optimum dose of the present findings (15 mg/kg body weight as a first dose and 20 mg/kg body weight as a second dose) with a slight variance.

Rao and Janakiram (1991) showed that female *Clarias batrachus* could be readily spawned even when administered a much lower dose of Indian major carp pituitary extract 30 mg/kg body weight. The males did not require to be hypophysectomized at all. Tripathi (1996) also referred 30 mg/kg body weight of PG as a single dose for female in *C. batrachus* for induced spawning. Sharma *et al.* (2010) though used another type of hormone ovotide at the rate of 1ml/kg body weight to induce the fish *Clarias batrachus* and found that about 82% of females were ovulated. In the present study the PG dose (D<sub>4</sub>) of 35 mg/kg body weight (15 mg/kg body weight as a first injection and 20 mg/kg body weight as a second injection) was found most effective for ovulation in the fishes.

Mahmood *et al.* (2003) compared two hormone actions on the induced breeding of *Clarias batrachus* and found that two doses of PG at the rate 15 mg/100g body weight ovulated the fish completely. In this case the amount of PG doses administered for ovulation were more or less same of present findings (optimum dose D<sub>4</sub> of 35 mg/kg body weight in total) with a slight variance.

Several workers worked on the induced breeding of different fishes other than *C. batrachus*. Kohinoor *et al.* (1991) suggested that *Anabas testudineus* could be induced with the single injection of 8-12 mg PG/kg body weight and ovulation occurred in all the injected females. The males were injected with only 4mg PG/kg body weight. In African catfish *Clarias gariepinus*,



Brzuska (2003) used carp pituitary at the rate of 4 mg/kg body weight and observed 100% ovulation. Mahmood (2003) used several PG doses at the rate of 8-16 mg/100g body weight for the breeding of *Anabas testudineus* and all the cases more or less 100% ovulation was found. Rahman *et al.* (2005) induced the long whiskered catfish, *Sperata aor* and giant river catfish, *Sperata seenghala* with the PG hormone at rate of 12-20 mg/kg body weight as an initial and 16-24 mg/kg body weight as a resolving dose and found the females were partially ovulated.

The differences in the results of various studies may be attributed to a number of factors, including (a) readiness of brood fish, (b) age and physiological state of brood fish, (c) seasonal variations, (d) environmental factors and (e) source, age and maturity of donor fish etc. To overcome this problem it is important to mention that in the present study several experimental trials were conducted in each month during the breeding season of the fish and this provided an opportunity to establish optimum doses specific to different months.

As evident from the results of the present study dose (D<sub>1</sub>) of 15.00 mg/kg body weight (1<sup>st</sup> injection 5.00 mg/kg and 2<sup>nd</sup> injection 10.00 mg/kg body weight) and dose (D<sub>2</sub>) of 25.00 mg/kg body weight (1<sup>st</sup> injection 10.00 mg/kg and 2<sup>nd</sup> injection 15.00 mg/kg body weight) resulted in lower rate of ovulation in the *C. batrachus*. But dose (D<sub>3</sub>) of 30.00 mg/kg body weight (1<sup>st</sup> injection 10.00 mg/kg and 2<sup>nd</sup> injection 20.00 mg/kg body weight) and above doses (D<sub>4</sub> and D<sub>5</sub>) resulted in 100% ovulation response in different months of the breeding season. In all the experimental trials, microscopic studies revealed that the eggs produced by the PG doses (D<sub>1</sub> and D<sub>2</sub>) of 15.00 mg/kg and 25.00 mg/kg body weight were mostly unripe and less hydrated and thus probably resulted in the lower rates of fertilization and subsequent hatching. The small fraction of eggs which eventually became fertilized exhibited abnormal development and thus explains why hatching rates were so poor in the fish treated with low level of PG. In case of PG dose (D<sub>3</sub>) of 30.00 mg/kg (1<sup>st</sup> injection 10.00 mg/kg and

2<sup>nd</sup> injection 20.00 mg/kg body weight) and above doses (D<sub>4</sub> and D<sub>5</sub>) of 35.00 mg/kg and 45.00 mg/kg body weight treated all females spawned and average fertilization, hatching and survival rates were comparatively higher than those treated with doses (D<sub>1</sub> and D<sub>2</sub>) of 15.00 mg/kg and 25.00 mg/kg body weight. In these cases, most eggs were found ripe and more hydrated and thus probably resulted in the higher fertilization and hatching success. The reason for this variation in ovulation rates might be due to the fact that in case of lower dose of PG adequate levels of follicle stimulating hormone (FSH), leutinizing hormone (LH) were not achieved in blood and there some fishes remained unspawned in spite of PG treatment. Further, the fish which responded under lower doses the process of ovulation might have been incomplete. Similar observation in induced breeding experiments were also observed by Woynarovich and Horvarth (1980).

In the present study it was observed that the highest corresponding fertilization rates with optimum dose of D<sub>4</sub> (total 35.00 mg/kg body weight, 1<sup>st</sup> injection 15.00 mg/kg and 2<sup>nd</sup> injection 20.00 mg/kg body weight) were found 83.99%, 86.41%, 86.99% and 84.17% respectively, in *Clarias batrachus* during the breeding season of 2010 and 2011 (Table-4.4). More or less similar observation was found by several workers. Cheah *et al.* (1990) also observed highest 81% fertilization when they induced *C. batrachus* with the carp pituitary gland. Mahmood *et al.* (2003) found highest 72.35% fertilization rate in same fish when they compared two hormones PG (at the rate of 15.00 mg/100g body weight as double dose) and HCG (at the rate of 400 i.u/100g body weight) for breeding purposes. Hossain *et al.* (2006) also observed 88.33% fertilization rate for wild in 2001 and 94.00% fertilization rate for F<sub>1</sub> generation in 2002 with the optimum dose of 55.00 mg/kg body weight (1<sup>st</sup> injection 10.00 mg/kg and 2<sup>nd</sup> injection 45.00 mg/kg body weight) in *C. batrachus*. Sharma *et al.* (2010) reported highest  $82.3 \pm 0.80\%$  fertilization rate in *C. batrachus* induced by hormone ovotide at the rate of 1.0 ml/kg body weight.

In the present study the highest corresponding hatching rates 80.19%, 81.45%, 81.84% and 78.86% were found with the optimum dose of D<sub>4</sub> (total 35.00 mg/kg body weight, as 1<sup>st</sup> dose 15.00 mg/kg and 2<sup>nd</sup> dose 20.00 mg/kg body weight) in *C. batrachus* during the breeding season of 2010 and 2011 (Table-4.4). The results can be compared with the findings of Hossain *et al.* (2006). He observed the highest hatching rate for wild in 2001 was 84.33% and for F<sub>1</sub> generation in 2002 was 89.67%, when the fish *C. batrachus* was induced by PG at the rate of 55.00 mg/kg body weight (1<sup>st</sup> injection was 10.00 mg/kg and 2<sup>nd</sup> injection was 45.00 mg/kg body weight). This is more or less very similar with the present findings.

Cheah *et al.* (1990) found the highest 67% hatching rate in *C. batrachus* treated with the carp pituitary hormone. Obviously this hatching rate is lower than the results of present findings treated with the PG dose of D<sub>4</sub>. But nearly similar to other corresponding hatching rates 67.69%, 69.39%, 69.85% and 68.20% respectively which were observed by the PG dose of D<sub>3</sub> (total 30.00 mg/kg body weight as 1<sup>st</sup> dose 10.00 mg/kg and 2<sup>nd</sup> dose 20.00 mg/kg body weight) in *C. batrachus* during breeding season of 2010 and 2011.

Sharma *et al.* (2010) also found less hatching rate 55.3±1.54% than the present findings in *C. batrachus* treated with ovatide hormone at the rate of 1.0 ml/kg body weight. The lower hatching rate 60.10 ± 3.21% than the present study was also found in *C. batrachus* induced with double PG doses at the rate of 15.00 mg/100g body weight by Mahmood *et al.* (2003).

During the experiment the corresponding survival rate with optimum PG dose of D<sub>4</sub> (total 35.00 mg/kg body weight as 1<sup>st</sup> dose 15.00 mg/kg and 2<sup>nd</sup> dose 20.00 mg/kg body weight) were 81.63% 82.72%, 83.77% and 80.72% respectively (Table-4.4). Similar work was done by Thakur *et al.* (1974). They observed the similar results. The rate of survival of hatchling in *C. batrachus* from hatchling upto 5<sup>th</sup> day was 60-84.71%. Rahmatullah *et al.* (1983)

observed the highest 84.71% survivability in *C. batrachus* when induced the fish with PG hormone. Hossain *et al.* in 2006, observed 99.67%, 98.67% and 96.67% survivability in different groups of *C. batrachus* treated with PG hormone.

From the above discussion it can be said that the different doses of PG hormone D<sub>1</sub>, D<sub>2</sub>, D<sub>3</sub>, D<sub>4</sub> and D<sub>5</sub> resulted different rates of ovulation, fertilization, hatching and survivability in *C. batrachus* during the breeding season of 2010 and 2011 but the dose of PG (D<sub>4</sub>) showed most effectiveness in all respect than other doses to breed the fish *C. batrachus*.

#### 4.4.2 For HCG doses

In general, artificial breeding with the help of hormones is a common practice nowadays. Different hormone preparations are used for artificial breeding purposes including Human Chorionic Gonadotropin (HCG) hormone. During the past decade, HCG was used successfully in fish breeding. Recently scientists have started to breed the fish artificially by using HCG. Khan and Mukhopadhyay (1975), Ahmed *et al.* (1981), Ahmed *et al.* (1985), Thakur and Das (1985), Mustafa *et al.* (1986) and Marte (1989) provided basic information on induced breeding of *C. batrachus* with a view to mass production of seeds. Therefore HCG was selected with an objective to determine the optimum dose for artificial breeding of the fish.

From the results obtained in the experiment it was found that the HCG dose D<sub>1</sub> at the rate of 1.00 i.u/100g body weight did not induce the fish to release the eggs. Dose D<sub>2</sub> at the rate of 2.00 i.u/100g body weight and dose D<sub>5</sub> at the rate of 5.00 i.u/100g body weight resulted in partial (33.33% to 66.66%) ovulation in different months of the breeding season. But dose D<sub>3</sub> at the rate of 3.00 i.u/100g body weight and dose D<sub>4</sub> at the rate of 4.00 i.u/100g body weight made 100% ovulation in all along the months of breeding season (Table-4.5). The similar results can be found in the observations of Mahmood and Shahadat (2003). They found 100% ovulation in *Clarias batrachus* treated with HCG at

the rate of 3.00, 4.00 and 5.00 i.u/100g body weight of the fish. Naser *et al.* (1990) used HCG dose at the rate of 4000 i.u/kg body weight for both the male and female to induce the fish *C. batrachus* and 100% ovulation occurred. Mahmood *et al.* (2003) compared two hormones in the breeding of *C. batrachus* and used HCG at the rate of 400 i.u/100g body weight as double dose, 100% ovulation was reported in that experiment. Sharma *et al.*, (2010) used another type of hormone ovotide at the rate of 1.0 ml/kg body weight and found  $81.9 \pm 0.19\%$  ovulation rate in the fish *C. batrachus*. Marte (1989) prescribed HCG dose 3000-4000 i.u/kg body weight for *C. macrocephalus* and 75-90% spawning response was observed. Shehadeh (1976) cited doses of HCG at the rate of 250-375 i.u/fish for spawning *C. batrachus*. In southern China 500-800 i.u/kg HCG and a combination of 500 i.u/kg HCG + 1mg/kg carp pituitary was commonly used for spawning the *C. batrachus* (Wembiao, *et al.* 1988).

Khan and Mukhopadhyay (1975) observed successful spawning of *C. batrachus* using HCG injection. Ahmed *et al.*, (1985) studied artificial breeding of *C. batrachus* under HCG induction and reported higher ovulation (100%). Thakur and Das (1985) stated that HCG is an effective inducing substance for *C. batrachus*; according to the authors HCG results in reasonable ovulation, fertilization and hatching.

During the experiments in *C. batrachus* it was observed that the HCG dose D<sub>3</sub> at the rate of 3.00 i.u/100g body weight resulted in the highest 80.82% to 83.90% fertilization rate in different months of the breeding season of 2011 and 2012. The lowest fertilization rate 13.04% to 27.65% was also found by applying the HCG dose D<sub>2</sub> at the rate of 2.00 i.u/100g body weight (Table-4.5).

Different workers observed the breeding parameters of *Clarias batrachus* and more or less found similar findings with the present study. Mahmood and Shahadat (2003) observed  $85.89 \pm 3.45\%$  fertilization rate in *C. batrachus*

treating with the HCG dose at the rate of 3.00 i.u/100g body weight. Mahmood *et al.*, (2003) found  $80.07 \pm 2.58\%$  fertilization rate in the same fish by applying the hormone HCG as double dose at the rate of 400 i.u/100g body weight. Das *et al.* (1992) applied HCG at 4500 i.u/kg body weight in *C. batrachus* and obtained 85% fertilization rate. Naser *et al.* (1990) induced *C. batrachus* with HCG in a single dose experiment at the rate of 4000 i.u/kg body weight and observed  $81.81 \pm 10.12\%$  fertilization rate.

Besides, several workers observed breeding performance of other catfishes than *C. batrachus*. Marx and Chakraborty (2007) induced another type of catfish *Heteropneustes fossilis* by inducing agent ovatide at the rate of 0.5 ml/kg body weight and observed satisfactory (highest 96.00%) rate of fertilization. Haniffa and Sridhar (2002) found highest 75.00% fertilization rate treated with HCG at the rate 2000 i.u/100g body weight in *H. fossilis*. Padmakumar *et al.* (2011) induced the endemic catfish *Horabagrus brachyosoma* by ovaprim at the rate of 1 ml/kg body weight and observed more than 90% fertilization rate.

In the present study though five different type of HCG doses, i.e. D<sub>1</sub>, D<sub>2</sub>, D<sub>3</sub>, D<sub>4</sub> and D<sub>5</sub> were applied but the dose (D<sub>3</sub>) at the rate of 3.00 i.u/100g body weight showed better performance than other doses regarding fertilization in *C. batrachus*.

During the experiment it was found that the HCG dose D<sub>3</sub> at the rate of 3.00 i.u/100g body weight resulted in highest 75.03% to 76.42% hatching rate and the lowest 12.29% to 23.81% hatching rate was observed in HCG dose D<sub>2</sub> at the rate of 2.00 i.u/100g body weight (Table-4.5). The similar results was also observed by Mahmood and Shahadat (2003) using the HCG dose at the rate of 3.00 i.u/100g body weight to induce the fish *C. batrachus* and recorded  $75.79 \pm 1.00\%$  hatching rate. Das *et al.* (1992) induced the catfish *C. batrachus* with HCG at 4500 i.u/kg body weight and observed fertilization and hatching rate.

The rate of hatching was 70.64% for the instantly obtained sperms and the percentage was nearly similar to the present findings. Ahmed *et al.* (1985) observed the hatching rate which varied from 20% to 75% in *C. batrachus* inducing the fish with HCG as a single dose for male and double dose for female at the rate of 1 i.u/g and 2-3 i.u/g of the body weight for male and female, respectively. Mahmood *et al.* (2003) compared two hormone preparations on the reproductive performance of air breathing catfish *C. batrachus*. They found  $70.45 \pm 3.60\%$  hatching rate treated with HCG dose at the rate 400 i.u/100g body weight. Naser *et al.* (1990) recorded lower hatching rate ( $66.4 \pm 9.32\%$ ) than the present findings working on the induced breeding of *C. batrachus* with the HCG at the rate of 4,000 i.u/kg body weight in a single dose method for both male and female. Haniffa and Sridhar (2002) observed 60.0% hatching rate in *Heteropneustes fossilis* treated with HCG at the rate of 3000 i.u/kg body weight. Mollah and Karim (1990) induced the African magur *Clarias gariepinus* with a mixture of 500 i.u HCG and 2 cPGE/kg body weight and found 60% to 75% hatching rate.

In the present study the survival rate of hatchling was also observed and recorded. The results obtained from five different doses of HCG i.e. D<sub>1</sub>, D<sub>2</sub>, D<sub>3</sub>, D<sub>4</sub> and D<sub>5</sub>, it was found that the highest survival rate achieved 75.71% to 78.42% during the different months of the breeding season with the HCG dose D<sub>3</sub> at the rate of 3.00 i.u/100g body weight and the lowest survival rate 21.48% to 41.37% was found with the HCG dose D<sub>2</sub> at the rate of 2.00 i.u/100g body weight (Table-4.5). The other doses of D<sub>4</sub> and D<sub>5</sub>. resulted in lower percentage of survivability than the result of dose D<sub>3</sub>. Similar result was also recorded by Das *et al.* (1992). They induced the fish *C. batrachus* with HCG dose at the rate of 4500 i.u/kg body weight and reared the fry in the tray with different stocking densities for fifteen days. The survival rate was more or less 78% to 80%

for different stocking densities. Sharma *et al.* (2010) found satisfactory rate of survivability (98.52%) in *C. batrachus* but they used ovatide as a inducing agent at the rate of 1 ml/kg body weight. Mollah *et al.* (1991) induced the *C. batrachus* by hormone and reared the hatchling in different trays upto 14 days. The survival rate was recorded 64.3% which is lower than the present findings.

From the above discussion it can be said that as an inducing agent HCG is very effective in the induced breeding of *Clarias batrachus*. From the results obtained in the present study it has been proved that the HCG dose  $D_3$  at the rate of 3.00 i.u/100g body weight is the most effective among the five doses i.e,  $D_1$ ,  $D_2$ ,  $D_3$ ,  $D_4$  and  $D_5$  applied for the induced breeding of *Clarias batrachus*.





# **CHAPTER 5**

## *Summary and Conclusion*

## CHAPTER 5

### SUMMARY AND CONCLUSION

#### Summary

##### **Hatcheries and Hatchery Management**

A survey of the fish hatcheries was conducted in the Rajshahi district during the period of January to December of 2010 and 2011. The overall objective of this study was to know the present status of the hatchery owners, to investigate the management practices followed by them, establishment year of hatcheries, hatchery standard, production of hatchlings, fry and price analysis, stocking and management of brood fishes, cost and profit analysis, problems of fish hatcheries etc. All the information were collected by questionnaire proforma during the time of frequent visits. Based on the findings of the survey the following summary could be drawn.

During the period of 1991-95, the highest 27.77% hatchery were established in the surveyed area. Basically the hatchery owners have been categorized in to two types, i.e., only hatchery business and hatchery + others. It was found that comparatively more educated people are involved in fish farming. Regarding training status it was observed that most of the hatchery owners (88.89%) received training from home or abroad. About 38.89% owners had funds for seed productions from their own sources. Bank, money lenders, relatives also provided fund to establish the fish hatcheries in the surveyed area.

During the survey period it was found that about 55.56% hatcheries were constructed in own land. Some farms were also established in leased property. For transportation of brood fishes and spawns in many cases the non-mechanized vehicles, vans and mechanized vehicles motorcycles, tempo were used. About 55.55% hatchery owners were satisfied with existing communication facilities, because most of the hatcheries are situated in road side and nearly urban areas, while only 16.67% were unsatisfied with existing

communication facilities. Employees of hatcheries were employed on the temporary and permanent basis. Employees were both skilled and unskilled. The specialists employed in the hatcheries are locally known as fish doctor.

Majority of the fish hatcheries were in between 06-10 decimals. But they had sufficient land around the hatchery complex. Every fish hatchery had brood stock pond which ranged from 2-8. The physicochemical and biological characteristics of the ponds were satisfactory. Water temperature, DO, pH, DCO<sub>2</sub>, alkalinity and hardness were normal in range. Maximum (83.37%) hatchery owners reported about seldom attack of fish disease in their hatcheries. In the surveyed area most of the hatchery owners reported that they used only underground water for hatchery purpose. They had overhead tank, circular breeding tanks, circular hatching tanks, houses or cisterns, jars or bottles in their farms for breeding purposes. Most of the owners were satisfied with water and soil qualities of the ponds.

Different chemicals such as potash, bleaching powder, detergent powder, formalin, copper sulphate, methyl blue, lime etc. were used to clear or hygiene the hatchery establishment. Most of the hatchery owners collected brood fishes for breeding purposes from their own source. They had provision of stocking the brood fishes in own care. For this there were separate brood fish stocking and rearing ponds in the hatcheries. Majority of the fish farms used supplementary feeds and fertilizers for the better production. 5 native carps, i.e. rui, catla, mrigel, calibaush and bata and 5 exotic carps i.e silver carp, bighead carp, grass carp, common carp and raj puti were stocked and reared for breeding purposes.

Maximum hatchery owners strictly followed the conditioning of brood fishes. The maximum conditioning time was 12 hours and minimum time was 6 hours. During the investigation it was observed that 50% hatchery owners collected eggs from brood fishes twice in the breeding season. Mainly they used pituitary gland extract (PG) and human chorionic gonadotropin (HCG) hormone as inducing agents.

The production capacity and annual production of 18 surveyed hatcheries under the Rajshahi district varied due to different causes. The total fry production of 18 hatcheries was 8200 kg in 2010 and 8380 kg in 2011. To the question of the demand of hatchlings maximum hatchery owners answered rui as the best species (33.33%), followed by silver carp (27.78%), bata (22.22%), common carp (11.11%) and mrigel (05.56%). From the investigation it was observed that most of the hatchery owners (50.00%) supplied their hatchlings within the local area.

Prices of inputs and outputs were almost same among the surveyed fish hatcheries. Maximum sale price of spawn was highest 3000/- Tk. at the start of the season and was lowest 100/- Tk at the end of the season. From the investigation it was found that fish seed production is the profitable business in the surveyed area. The hatchling production time of different species was not the same. Normally it starts from late March and ends in September.

The present study recorded some problems and constraints connected with hatchery operation. These were listed under four headings such as technical, economical, social and natural. Among the problems, lack of technical knowledge, failure of electricity supply, insufficient water in dry season, lack of credit, lack of marketing facilities were the important ones. To get lease of ponds was the major ones as claimed by the hatchery owners.

Besides, inbreeding and hybridization were the major problems of the study area. Inbreeding decreased the rate of growth, survival, fertility, reproduction performance, resistance power etc. and unplanned hybridization is naturally decomposed of originality of different species.

From this study it can be concluded that fish seed farm business was accepted by the owners as a profitable one. To ensure an increase in seed production and also to increase its profitability the hatchery operators should be given facilities on training program and input availabilities, they should also be provided with

credit facilities. Simultaneously the problems and constraints which were identified by the hatchery owners should be solved by the concerned authorities.

### **Induced breeding of *Clarias batrachus***

The second part of the present study deals with the induced breeding of *Clarias batrachus*. The study was carried out during two breeding seasons of 2010 and 2011. In *C. batrachus* the breeding season generally starts from April and ends in August. In the present investigation different doses of PG and HCG were applied in different months and the effect of doses were observed on egg release response, fertilization, hatching, survivability etc. Finally the optimum dose was selected for different months. The findings of the present investigation are summarized bellow.

Before the induce breeding work, mature male and female brood fishes were selected according to their external sex characters. Then the brood fishes were kept in separate cemented tanks with hatchery water under continuous water showering. The conditioning period was six to eight hours. This was done to acclimatize the fishes in the new hatchery condition.

Prior to actual experimentation a number of range finding tests were conducted to set the range of PG dose to be used in actual experiment. On the basis of the results obtained from range finding tests five different doses (D<sub>1</sub>, D<sub>2</sub>, D<sub>3</sub>, D<sub>4</sub> and D<sub>5</sub>) were selected for the experiment. In case of HCG it was observed that fishes did not respond below the dose 1 i.u./100g body weight. So, for better result 1 i.u./100g body weight was taken as the lower limit of HCG doses to be injected in actual experimental trial. In the present investigation five different doses (D<sub>1</sub>, D<sub>2</sub>, D<sub>3</sub>, D<sub>4</sub> and D<sub>5</sub>) of human chorionic gonadotropin hormone were selected.

The broods were injected intramuscularly at the base of the pectoral fin. Inducing the fish by PG the first injection was given to both males and females but the second injection was given only to the females. But inducing the fishes by HCG all the experimental males and females were given a single injection.

In the month of April the PG dose D<sub>4</sub> (1<sup>st</sup> injection 15.00 mg/kg and 2<sup>nd</sup> injection 20.00 mg/kg body weight) resulted in the highest percentage of egg release, fertilization, hatching and survival rate i.e. 100%, 83.99%, 80.19% and 81.63% respectively and was selected as the optimum dose.

In the month of May the highest percentage of ovulation, fertilization, hatching and survival rate i.e. 100%, 86.41%, 81.45% and 82.72% were found by the PG dose D<sub>4</sub> and was treated as the most optimum dose in this month.

In the month of June the highest results regarding ovulation, fertilization, hatching and survival was also observed by PG dose D<sub>4</sub> and that was 100%, 86.96%, 81.84% and 83.77% respectively. So the dose D<sub>4</sub> is recommended as the optimum dose for *C. batrachus* in this months.

In the month of July the ovulation, fertilization, hatching and survival rates were 100%, 84.71%, 78.86% and 80.72% respectively and it resulted from the PG dose of D<sub>4</sub>. So PG dose D<sub>4</sub> was selected as the optimum dose.

Among the five different HCG doses i.e. D<sub>1</sub>, D<sub>2</sub>, D<sub>3</sub>, D<sub>4</sub> and D<sub>5</sub> at the rate of 1.00 i.u/100g, 2.00 i.u/100g, 3.00 i.u/100g, 4.00 i.u/100g and 5.00 i.u/100g body weight respectively, the dose D<sub>3</sub> at the rate of 3.00 i.u/100g body weight was found to be the most optimum dose in *C. batrachus* for all the breeding parameters like ovulation, fertilization, hatching and survival of hatchling.

During the experimental period it was observed that the HCG dose D<sub>3</sub> at the rate of 3.00 i.u/100g body weight showed the highest rate of ovulation, fertilization, hatching and survival in *C. batrachus* all the months of April, May, June and July of 2010 and 2011.

## Conclusion

On the basis of the present investigation and findings the following remarks and recommendations are made.

- i) Present level of institutional credit of fisheries farm is not sufficient to meet the demand for credit of the owners of fish hatcheries. Since these hatcheries are profitable, financial institutions should come forward to provide required credit to the genuine farmers for establishing new fish hatcheries.
- ii) In order to meet the demand for brood fishes for induced breeding, production of brood fishes through scientific management should be increased.
- iii) For overcoming the inbreeding problem, the hatchery owners can exchange brood fishes among their hatcheries. It is advisable to set up "brood bank" for successful hatchery operation in terms of quality seeds.
- iv) Government should take positive steps to train up the concerned interested farmers on modern methods of brood fish rearing, induced breeding, hatchery and nursery management.
- v) More emphasis should be given on nursery pond management.
- vi) For induced breeding, supply of various types of inputs should be ensured at low cost and government should control and check the quality of inputs.
- vii) For better seed production appropriate dosage of hormone should be administered.
- viii) Poor quality fish seeds due to inbreeding depression in the private hatcheries must be stopped.
- ix) An effective mechanism for information exchange between the farmers and researchers has to be developed and maintained.

Apart from some adverse socio-economic condition and impacts fish hatcheries present in this region can contribute a remarkable part of inland fish production in Bangladesh. As the fisheries sector plays a vital role in the socio-economic development, opportunity for employment, poverty alleviation of large number of population, all adverse impacts of aquaculture for sustainable growth in the future should be reduced. The NGOs and government should provide all the modern facilities in connection with the quality fish seeds production in Bangladesh.





*References*

## REFERENCES

- Abraham, T.J., Sil, S.K. and Vineetha, P. 2010. A comparative study of the aquaculture practices adopted by fish farmers in Andhra Pradesh and West Bengal. *Indian J. Fish.* **57(3)**: 41-48.
- Ahmed, A.T.A., Mustafa, G., Islam, K.R. and Hai, A. 1981. Observation on the induced spawning of *Clarias batrachus*. *Bangladesh J. Agri.* **6(1)**: 1-6.
- Ahmed, K., Mustafa, G., Ali, S. and Shajahan, M. 1985. Induced spawning of magur fish, *Clarias batrachus* (L.) by stripping method in a plastic bowl hatchery. *Bangladesh J. Zool.* **13(1)**: 19-24.
- Ahmed, K.K. and Chowdhury, M.A.K. 1998. Evaluation on propagation of common carp (*Cyprinus carpio* Lin.) with hormonal and natural stimuli. *Bangladesh J. Fish Res.* **2(1)**: 1-8.
- Ahmed, M.K. 1983. Induced breeding of major carps, Chinese carps and catfish. Freshwater fish Res. Sta. Chandpur, Bangladesh. 44-52.
- Akankali, J.A., Seiyaboh, E.I. and Abowei, J.F.N., 2011. Fish hatchery management in Nigeria. *Adv. J. Food Sci. Technol.* **3(2)**: 144-154.
- Akhteruzzaman, M., Kohinoor, A.H.M., Hussain, M.G. and Shah, M.S. 1991. Observation on the induced breeding of *Mystus cavasius* (Hamilton) in Bangladesh. *Bangladesh J. Fish.* **14(1-2)**: 101-105.
- Alam, A.K.M.A. 1983. Low cost hatchery. *Adam news.* **10(1)**: 27-33.
- Alam, A.K.M.N., Islam, M.A., Mollah, M.F.A., Haq, M.S. and Rahman, M.S. 1985. Growth of silver carp, *Hypophthalmichthys molitrix* (Val.) with reference to some limnological parameters of rearing ponds. *Bangladesh J. Fish.* **8(1-2)**: 9-15.
- Alam, M.J., Begum, M., Islam, M.A. and Pal, H.K. 2006. Spawning behaviour and induced breeding of an estuarine catfish, *Mystus gulio* (Ham.), *Bangladesh J. Fish. Res.* **10(2)**: 101-109.

- Alam, M.J., Begum, M., Pal, H.K., Islam, M.A. and Mamun, A.A. 2008. Preliminary success on hormone induced captive breeding of goldspot mullet, *Liza parsia* (Ham). *Bangladesh J. Fish. Res.* **12(2)**: 151-156.
- Alam, M.M. and Bhuiyan, A.S. 1999. Determination of optimum PG dose for induced spawning of *Labeo rohita* (Hamilton, 1822). *Unvi. J. Zool. Rajshahi Univ.* **18**: 103-108.
- Ali, M.H. 1967. Induced breeding of major carps in ponds by pituitary hormone injection. *Agric. Inform. Serv.* Dhaka 3p.
- Ali, M.H., Akbar, M.A. and M.H. Rahman, 1982. Utilization of fish ponds in Mymensingh district. *Bangladesh J. Agrical. Econ.* **5(1-2)**: 103-114.
- Ali, M.L. 1998. Fishery resources development and management technique. *Fish Week 98 Compendium*, Department of Fisheries. Ministry of Fisheries and Livestock. Dhaka, Bangladesh. 1-10 pp.
- Ali, M.Y. 1967. Induced spawning of major carps, Chinese carps and catfish-A manual for extension. Freshwater fish Res. Sta. Chandpur, Comilla, Bangladesh.
- Alikunhi, K.H., Vijayalakshmanan, M.A. and Ibrahim, K.H. 1957. Preliminary observations on the spawning of Indian carps, induced by injection of pituitary hormones. *Indian J. Fish.* **7(1)**: 1-19.
- Amin, M.N. 2005. Status of fish brood stock management and seed production in Bangladesh. *Bangladesh J. Fish Res.* **9(1)**: 15-16.
- Anonymous, 1999. *Annual Report*. Department of Fisheries, Dhaka, Bangladesh. 1-152.
- Banik, R.C.K and Humayun, N. 1998. Fishery resources statistics, *Fish week, 1998 Compendium*, Department of Fisheries, Bangladesh, Dhaka. 100-102 pp.

- BBS, 2007. Various issues, Statistical yearbook of Bangladesh. Bangladesh Bureau of statistics, Ministry of Planning, Government of Peoples Republic of Bangladesh, Dhaka.
- Bhowmick, R.M., Kowtal, G.V., Jana, R.K. and Gupta, S.D. 1978. Large scale production of the seed of *Catla catla* (Ham.) by hypophysation. *J. Inland Fish. Soc. India*. **10**: 3.
- Bhuiyan, A.L. 1964. Fishes of Dacca, *Asiatic Soc. of Pakistan*. Pub. No. **13**: P-148.
- Bhuiyan, A.S. 1996. Small indigenous fish biodiversity and the present status of fishery resources in the north-western region of Bangladesh. *Proceeding on national workshop on small indigenous fish culture in Bangladesh. IFADEP-2 and Dept. of Zoology, R.U.* 65-70.
- Bhuiyan, A.S., Islam, M. Khairul and Zaman, T., 2006. Induced spawning of *Puntius gonionotus* (Bleeker). *J. Bio-sci.* **14**: 121-125.
- Bhuiyan, A.S., Islam, M.N. and Hossain, M.T. 1992. A check list of the fishes of Rajshahi. *The Rajshahi Unive. Studies*. Part-B (**20**): 287-306.
- Bhuiyan, A.S. and Rahman, M. 1989. Effects of six different supplementary feeds on the growth of the hatchlings of fish *Cirrhina reba*. *Environ. Ecol.* **7(4)**: 975-977.
- Bhuiyan, A.S., Musa, A.S.M. and Islam, M.K. 2008a. Hatchery management in Bangladesh. *Univ. J. Zool. Raj. Univ.* **12**: 20-23.
- Bhuiyan, A.S., Musa, A.S.M. and Islam, M.K. 2008b. Hatchery management in Bangladesh. *Aquaculture Asia Magazine, Genetics and Biodiversity*, **April-June**: 20-24.
- Bhuiyan, A.S., Musa, A.S.M. and Islam, M.K. 2008. Some observations on the induced spawning of *Labeo rohita* (Hamilton, 1822) by pituitary hormone injection. *Bangladesh J. Life Sci.* **20(1)**: 89-94.

- Bhuiyan, A.S., Nessa, Q. and Begum, M. 1998. Breeding season of the fresh water barb, *Puntius gonionotus* (Bleeker) (Cyprinidae : Cypriniformes). *Rajshahi University Studies, Part-B* **26**: 115-117.
- Blaylock, G.G. and Griffith, N.A. 1971. A laboratory technique for spawning carp. *Progr. Fish. Cult.* **33(1)**: 45-50.
- Brzuska, E. 2003. Artificial propagation of African catfish (*Clarias gariepinus*): differences between reproduction effects after stimulation of ovulation with carp pituitary homogenate or GnRH-a and dopaminergic inhibitor. *Czech J. Anim. Sci.*, **48(5)**: 181-190.
- Brzuska, E., 2001. Artificial spawning of carp (*Cyprinus carpio* L.): the use of aquaspawn and carp pituitary to induce ovulation in females of Lithuanian line B. *Aquaculture Research*, **32**: 357-364.
- \*Cardoso, D.M. 1934. Relacao-genito hipofisaria a reproducao nos peixes (in Spanish). *Arch. Inst. Biol. S. Paulo.* **5**: 133-136.
- \*Chaubey, A.K. 1995. Performance of hatchery and field evaluation of Indian major carps. New Agriculturist, Biol. Research and Communication Centre. **6(1)**: 63-66.
- Chaudhuri, H. 1960. Experiments on induced spawning of Indian carps with pituitary injections. *Indian J. Fish.* **7(1)**: 20-48.
- Chaudhuri, H. 1969. Breeding habits of cultivated fishes. FAO/UNDP Regional seminar on induced breeding of cultivated fishes, Calcutta, Cuttack and Bombay, July 15-August 18: 1969. 13p.
- Chaudhuri, H. and Alikunhi, K.H. 1957. Observations on the spawning in Indian carps by hormone injection. *Current science, No. 12.* **26(12)**: 381-382.
- Chaudhuri, S.N. 2001. Brief development of fisheries, Department of Fisheries, Ministry of Fisheries and Livestock, Bangladesh. 45p.

- \*Cheah, S.H., Siraj, S.S. and Ang, K.J. 1990. A preliminary study on induced spawning of the catfish *Clarias batrachus* (Linnaeus) in Malaysia. *Pertanika* **13(1)**: 63-66.
- Das, B. 1997. *Fish and Fisheries management*. Bangla Academy, Dhaka, Bangladesh. 362 pp.
- Das, M., Islam, A.M. and Mughal, G.U. 1992. Induced breeding and fry rearing of catfish, *Clarias batrachus* (Linn.), *Bangladesh J. Zool.* **20(1)**: 87-95.
- Das, S.K. 2002. Seed production of magur (*Clarias batrachus*) using a rural model portable hatchery in Assam, India – A farmer proven technology. *Aquaculture Asia*. **7(2)**: 19-21.
- Davy, F.B. and Chouinard, A. 1980. Induced fish breeding in South-east Asia, reports of a workshop held in Singapore, 25-28 November, 1980. IDRC-1780, Canada, 48.
- Day F. 1958. The fishes of India, William, Dawson and Sons. Ltd. London. **1**: 486-487.
- Dewan, S., Hossain, M.S., Islam, M.S. and Hossain, S.M.A. 1988. Exploration of pond fish production under village condition. *Bangladesh J. Fish.* **11(2)**: 101-104.
- DoF, 2002a. Fish Culture Manual (Bengali), Matshaw Pakkah, 10-24<sup>th</sup> August, Directorate of Fisheries, Bangladesh. 66-80 pp.
- DoF, 2002b. Soronika, Matshaw Pakkha, 10-24<sup>th</sup> August, Directorate of Fisheries, Bangladesh, 44-70 pp.
- DoF, 2008. Sonkolon, *Matshow sampad unnoin avijan*, 23-30<sup>rd</sup> August, Directorate of Fisheries, Bangladesh. 34-36pp.
- DoF, 2009. Sonkolon, Jatio Matshaw Saptah, 30<sup>th</sup> July - 05<sup>th</sup> August, Directorate of Fisheries, Bangladesh. 105-111 pp.
- DoF, 2010. Sonkolon, Jatio Matshaw Saptah, 21-27<sup>th</sup> July, Directorate of Fisheries, Bangladesh, 102-108 pp.

- DoF, 2011. Sonkolon, Jatio Matshaw Saptah, 20-26<sup>th</sup> July, Directorate of Fisheries, Bangladesh, 117-124 pp.
- FAO, 2000. The state of world fisheries and aquaculture 2000, Rome, 142p.
- Fijan, N. 1975. Induced spawning, larval rearing and nursery operations of *Silurus glanis*. Workshop on controlled reproduction of cultivated fishes. EIFAC / T25: 130-138.
- FLID, 1992. *Extensive fish culture manual and year calendar (3<sup>rd</sup> ed.,) 1993*. Fisheries and Livestock Information Department, Bangladesh, 2-20pp.
- FRSS, 2010. Fishery Statistical Yearbook of Bangladesh, 2008-2009. Fisheries resources survey system (FRSS), Directorate of Fisheries, Bangladesh. Vol. **26** No. **1**.
- FRSS, 2011. Fishery Statistical Yearbook of Bangladesh 2009-2010. Fisheries resources survey system (FRSS), Directorate of Fisheries, Bangladesh. Vol. **27**.
- \*Gerking, S.O. 1967. The biological basis of fresh water fish production. *Blawell Scientific Publication*, Oxford Edinburgh. 120-122 pp.
- Gill, G.J. and Motahar, S.A. 1982. Social factors affecting prospects for intensified fish farming in Bangladesh. *Bangladesh J. Agriculture Economy*, **5(1-2)**:1-24.
- Haniffa, M.A.K. and Sridhar, S. 2002. Induced spawning of spotted murrel (*Channa punctatus*) and catfish (*Heteropneustes fossilis*) using human chorionic gonadotropin and synthetic hormone (Ovaprim). *Veterinarski Arhiv*. **72(1)**: 51-56.
- Haque, K.A. 1975. Some observations on the induced spawning of major carps by pituitary hormone injection. Freshwater fish Res. Sta. Chandpur. Bull. No. **1**: 19-33.

- Haque, M.M., Kabir, H., Rahman, M.H. and Sarwer, R.H., 2003. An empirical study on income and efficiency of pond fish and nursery fish production in some selected areas of Pabna, Bangladesh. *Bangladesh J. Fish Res.*, **7(1)**: 93-100.
- Haque, M.T. and Ahmed, A.T.A. 1993. Spawning periodicity of two Indian major carps, *Labeo rohita* (Ham.) and *Cirrhina mrigala* (Ham.). *Bangladesh J. Zool.* **21(2)**: 9-26.
- Haque, M.Z., Kohinoor, A.H.M., Mahata, S.C. and Mazid, M.A. 1996. The spawning success and egg quality of major carps under varied hormone doses. *J. Asiat. Soc. Bangladesh. Sci.* **22(1)**: 79-84.
- Haque, M.Z., Kohinoor, A.H.M., Rahman, M.A. and Mazid, M.A. 1995. Egg quality of Chinese carps under different hormone doses. *J. Asiat. Soc. Bangladesh. Sci.* **21(1)**: 209-216.
- Haroon, A.K.Y., Alam, M. and Mazid, M.A., 1994. Experimental study of paddy-cum-fish/prawn farming in Bangladesh III. Effect of supplemental feed on giant fresh-water prawn and trials with silver barb and tilapia. *Bangladesh J. Zool.* **22(1)**: 89-95.
- \*Harvey, B.J. and Hoar, W.S., 1979. The theory and practice of induced breeding in fish. IDRC publication, Ottawa, Ont. IDRC. pp. 48.
- Hasan, M.R. and Ahmed, G.U. 2002. Issues in carp hatcheries and nurseries in Bangladesh, with special reference to health management, FAO, Fisheries Tech. Paper, Dept. Aquaculture. Bangladesh Agril. Univ. Mymensingh 2002 (406): 147-164.
- Hoque, M.T. and Ahmed. A.T.A. 1991. A preliminary observation in induced breeding of rohu. *Labeo rohita* (Ham.) in stagnat water. *J. Asiat. Soc. Bangladesh Sci.* **17(2)**: 93-98.
- Hossain, D.G. and Siddiqui., A.B. 2009. Present status of hatcheries and fish production of Rajshahi, BSS, Rajshahi, Bangladesh. 2 p.



- Hossain, M.K., Latifa, G.A. and Rahman, M.M. 2008. Observation on induced breeding of snake-head murrel, *Channa striatus* (Bloch, 1793). *Int. J. Sustain, Crop Prod.* **3(5)**: 65-68.
- Hossain, Q.Z. 2001. Induced breeding of the fish *Cirrhinus reba* by pituitary gland extract and survival of spawn in nursery ponds. *J. Asiat. Soc. Bangladesh Sci.* **27(2)**: 205-213.
- Hossain, Q.Z., Hossain, M.A. and Parween. S. 2006. Artificial breeding and nursery practices of *Clarias batrachus* (Linnaeus, 1758). *Scientific World.* **4(4)**: 32-37.
- Hussain, M.G., Obaidullah, M., Rahman, M.N., Akteruzzaman, M. and Perschbacher, P. 1987. Hormone-induced ovulation and spawning of *Puntius gonionotus* (Bleeker). *Bangladesh J. Fish.* **10(1)**: 1-4.
- Islam M. Khairul, 2006. Reproductive biology and induced spawning of *Labeo rohita* (Hamilton) and *Puntius gonionotus* (Bleeker) with reference to the hatchery management in south-western region of Bangladesh. Ph.D. Thesis (Awarded). IBSc, Rajshahi University, Rajshahi.
- Islam, A. 1983. A report on aquatic culture in Bangladesh. *Bgd. Fish. Inf. Bull.* **1(2)**: 28 p.
- Islam, M.A. and Collis, W.J. 1998. Final report, volume-4. Fresh water aquaculture, Preparatory phase of national fisheries sector development program, 4<sup>th</sup> Fisheries project. Directorate of Fisheries, Bangladesh. 12-18 pp.
- Islam, M.A., Chowdhury, M.Y. and Karim, R. 1978. A comparative study of some physico-chemical factors and growth of major carps in ponds. *Bangladesh J. Aqua.* **1(1)**: 64-78.
- Islam, M.N. and Bhuiyan, A.S. 1990. Effects of some supplementary feeds on the growth of hatchlings of *Cirrhina mrigala*. *Univ. J. Zool, Rajshahi Univ.*, **9**: 11-16.

- Islam, M.S. and Dewan, S. 1986. Economics of pond fish culture in some selected areas of Bangladesh. *Bangladesh J. Aquaculture*. **8(1)**: 57-61.
- Islam, M.S. and Dewan, S. 1988. Status and economic efficiency of fish seed multiplication farms in Bangladesh. *Bangladesh J. Agril. Econ*. **9(1)**: 69-79.
- Islam, M.S., Mustafa Kamal, A.H.M., Wahab, M.A. and Dewan, S., 2004. Water quality parameters of coastal shrimp farm from southwest and southeast region of Bangladesh. *Bangladesh J. Fish Res.*, **8(1)**: 53-60.
- Islam, M.S., Rahman, M.S. and Mazid, M.A. 1997. Effect of fertilizers on the growth and survival of black carp (*Mylopharyngodon piceus*) hatchlings in nursery ponds. *Univ. J. Zool. Rajshahi Univ.* **16**: 7-10.
- Islam, M.S., Shofiquzzoha, A.F.M., Rahman, M.S. and Shah, M.S. 1996. Preliminary understanding of different hormonal regimes of induced breeding of Black carp (*Mylopharyngodon piceus*), *Univ. J. Zool. Rajshahi Univ.* **14&15**: 41-46.
- Islam, Z. and Chowdhury, A.Q. 1976. Induced spawning of major carp for commercial production and fry in the fish seed farm, *Bangladesh J. Zool.* **4(2)**: 51-61.
- Islam. M.N., Chawdhury, M.F.R. and Mohsin, A.B.M. 2002. Role of hatchery in the fish culture development of Rajshahi district in Bangladesh. *Univ. J. Zool. Rajshahi Univ.* **21**: 73-76.
- Jewel, M.A.S., Rahman, M.M. and Islam, M.N., 2006. Study of genetic variation in different hatchery populations of common carp (*Cyprinus carpio*) of Mymensingh district in Bangladesh using microsaellite DNA markers. *J. Bio-Sci.* **14**: 113-120.
- Jhingran, V.G. 1968. Synopsis on biological data on *Catla catla* (Ham.). *FAO Fisheries Synophsis*, No. **32**: Rev. 1, Rome.

- Jhingran, V.G. and Pullin, R.S.V. 1985. A hatchery manual for the common Chinese and Indian major carps. *Centre for living Aquatic Resource Management*, Manila, Philippines, 166pp.
- Kabir, M.H., Malek, M.A. and Serajul Islam, M. 2001. Resource productivity and economic performance of production fish seeds in government and private farms in Bangladesh. *Bangladesh J. Fish Res.* **5(1)**: 85-94.
- Khaleq, M.A. 2002. Fishery resources of Rajshahi division (in Bengali). *Matshaw Pokkho Sonkolon 2002*. Directorate of Fisheries, Bangladesh. 10-14 pp.
- \*Khan, H.A. 1938. Ovulation in fish (effect of administration of anterior lobe of pituitary gland). *Curr. Sci.* **7(5)**: 233-234.
- Khan, H.A. 1944. Observations on the spawning behaviour of crap in Panjab. *Proc. Nat. Inst. Sci. India.* **11(3)**: 315-320.
- Khan, H.A. 1972. Induced breeding of air breathing fishes. *Indian Farming.* **22**: 44-45.
- Khan, H.A. and Mukhopadhyay, S.K. 1975. Production of stocking material of some air breathing fishes by hypophysation. *J. Inland Fish. Soc. India,* **7**: 156-161.
- Knud-Hansen, C.F., Batterson, T.R., McNabb, C.D., Hadiroseyani, Y., Dana, D. and Muhammed Eidman, H. 1990. Hatchery techniques for egg and fry production of *Clarias batrachus* (Linnaeus), *Aquaculture*, **89**: 9-19. Elsevier Science Publishers B.V. Amsterdam.
- Kohinoor, A.H.M., Akhteruzzaman, M., Hussain, M.G. and Shah, M.S. 1991. Observation on the induced breeding of koi fish, *Anabas testudineus* (Bloch) in Bangladesh. *Bangladesh J. Fish.* **14(1-2)**: 73-77.
- Kohinoor, A.H.M., Haque, M.Z., Hussain, M.G., Gupta, M.V. and Mazid, M.A. 1995. Induced breeding of *Puntius sarana* Hamilton and *P. gonionotus* Bleeker. *J. Asiat. Soc. Bangladesh Sci.* **21(2)**: 139-144.

- \*Lin, S.Y. 1965. Induced spawning of Chinese carps by pituitary injection in Taiwan, *JCRR Fish Ser.* **5**: 1-31.
- Linhart, O., Gela, D., Rodina, M. and Kocour, M. 2004. Optimization of artificial propagation in European catfish, *Silurus glanis* L. *Aquaculture*, **235**: 619-632.
- Madu, C.T., 1984. Potentials for marine fish hatchery production in Nigeria. *National Institute for Freshwater Fisheries Research, P.M.B. 6006, New Bussa, Nigeria.* pp. 290-293.
- Mahmood, S.U. 2003. Effects of pituitary gland extract doses on the breeding performance of Koifish *Anabas testudineus* (Bloch 1792). *Bangladesh J. Zool.* **31(2)**: 195-201.
- Mahmood, S.U. and Shahadat Ali, M. 2003. Effects of different doses of Human Chorionic Gonadotropin (HCG) on breeding performance of walking catfish, *Clarias batrachus* (Linn.). *J. Asiat. Soc. Bangladesh Sci.* **29(2)**: 91-98.
- Mahmood, S.U., Ahmed, K., Ali, M.S. and Hoque, M.E., 2003. Comparison of two hormone preparations on the reproductive performance of air breathing catfish *Clarias batrachus* (Lin.). *Bangladesh J. Fish. Res.* **7(1)**: 21-26.
- Mahmood, S.U. and Shahadat Ali, M. 2004. Effects of different doses of pituitary gland extract on breeding the Goldfish *Carassius auratus*. *Bangladesh J. Zool.* **32(1)**: 1-6.
- Mannan A. 1997. Nutritional aspects of marine fishes and fisheries products, National marine fisheries seminar, 1977. Chittagong.
- Marimuthu. K., Haniffa, M.A. and Rahman, M.A., 2009. Spawning performance of native threatened spotted snake-head fish, *Channa punctatus* (Actinopterygii: Channidae: Perciformes), induced with ovatide. *Acta Ichthyologica Et Piscatoria.* **39(1)**: 1-5.

- Marte, C.L., 1989. Hormone-induced spawning of cultured tropical finfishes. *Advances in tropical aquaculture*, Tahite, February 20 – March 4. *Aquacop Ifremer Actes de Colloque*. **9**: 519-539 pp.
- Marx Karal, K. and Chakraborty, R. 2007. A comparative study on the induced breeding and *in vitro* fertilization performance by various inducing agents in catfish, *Heteropneustes fossilis* (Bloch). *Bangladesh J. Fish Res.* **11(1)**: 01-05.
- Menon, K.K.G. 1991. Basic approach for higher aquaculture productivity. In *aquaculture productivity*. Oxford and IBH publishing Co. Pvt. 418-428 pp.
- Miah, H., Tofazzal, M., Siddique, S., Sarwer, R.H. and Mazid, M.A. 2002. Investment in fish seed multiplication farms in Bangladesh: Evidence of an attractive business. *Bangladesh J. Fish. Res.* **6(1)**: 99-106.
- Miah, M.I., Bhuiyan, N.I. and Dewan, S. 1981. A comparative study on the rate of growth of major carps in relation to physico-chemical and biological factors. *Proc. 3<sup>rd</sup>. Nat. Zool. Conf. Banglaesh, Dhaka*. 215-224 pp.
- Miah, M.S., Uddin, M.S. and Shah, M.S. 1998. Effect of fertilizers on the growth of fishes under carp polyculture system. *Bangladesh J. Fish.* **21(2)**: 89-92.
- Mohsin, A.B.M., 2000. Present status on post stocking management and maintenance of improved traditional carp culture at Rajshahi and Natore area. *Univ. J. Zool. Rajshahi Univ.* **19**: 17-20.
- Molla, A.R., Chowdhury, S.N.I. and Habib, M.A.B., 1999. Input-output relations in fish production under various pond sizes, ownership pattern and constraints. *Bangladesh J. Training and Development*, **3(2)**: 87-101.
- Mollah, M.F.A. and Karim, M. 1990. First record of induced breeding of African catfish *Clarias gariepinus* (Burchell) in Bangladesh. *J. Inland Fish. Soc. India*, **22(1&2)**: 52-54.

- Mollah, M.F.A. and Khan, M.H.K. 1999. Observations on induced breeding of *Pangasius pangasius* (Hamilton). *Bangladesh J. Fish.* **22(1)**: 125-128.
- Mollah, M.F.A., Karim, M and Khatun, F. 1991. Comparison of larval growth rates and survival of three *Clarias* species. *J. Inland Fish. Soc. India*, **23(1)**: 42-44.
- Mondol, M.M.R., Sarker, M. Al-Amin and Hossain, M.A. 2006. Present fisheries status of Sariakandi fish pass, Sariakandi, Bogra. *J. Bio. Sci.* **14**: 137.
- Mortezavizadeh, S.A., Feshalami, M.Y. and Kahkesh, F.B. 2010. Effect of GnRH $\alpha$  (D-Ala $^6$ , des-Gly 10m GnRH $\alpha$ ), LHRH-a (des-Gly 10, [D-Ala $^6$ ] LH-RH Ethylamid) and carp pituitary in artificial propagation of Gattan, *Barbus xanthopetrus* (heckel, 1843). *World Journal of Fish and Marine Sciences.* **2(4)**: 280-284.
- Moula, S.M.S. 2011. India's Farakka dam strangulated the Ganges devastating fertile Bangladesh to a desert. <http://www.savebd.com/articles/india%E2%80%99s-farakka-dam-strangulated-the-ganges-devastating-fertile-bangladesh-to-a-desert>, 5 April 2011.
- Muniruzzaman, M., Zahura, U.A. and Chowdhury, M.B.R. 2002. Occurrence of Ichthyophthirias in carp nursery ponds and its chemotherapy. *Bangladesh Veterinarian*, Dept. Aquaculture, Faculty of Fisheries, *Agril. Univ. Mymensingh.* **19(1)**: 48-53.
- Musa, A.S.M. 2008. Effects of pituitary gland extract on the breeding performance of Gulsha tengra, *Mystus bleekeri* (Day). *Bangladesh J. Life Sci.* **20(1)**: 57-60.
- Musa, A.S.M. and Bhuiyan, A.S. 2007. Development of fish culture: Role of hatcheries of Admdighi Upazila of Bogra district. *Fishing Chimes. India.* **27(1)**: 131-133.

- Mustafa, G., Ahmed, K. and Shajahan, M. 1986. Effect of HCG (Human Chorionic Gonadotropin) and PG (Pituitary Gland) on induced spawning of the catfish, *Clarias batrachus* (Linn.), *Dhaka University Studies*, **34(2)**: 159-165.
- Naser, M.N. and Mozumder, P.K. 2004. Effects of transportation stress on growth, survival and feeding of carp hatchlings in nursery ponds transported in oxygenated bag and aluminium pitcher. *Banglaesh J. Fish.* **27**: 19-20.
- Naser, M.N., Shafi, M., Shah, M.S. and Barua, G., 1990. Development of a new methodology on the artificial propagation of catfish *Clarias batrachus* (L.) by influencing some physico-chemical parameters of the water. *Bangladesh J. Zool.* **8(1)**: 23-31.
- Naser, M.N., Shafi, M., Shah, M.S. and Barua, G., 1991. On the productivity of catfish, *Clarias batrachus* (L.) fry-rearing ponds at Mymensingh, Bangladesh. *Bangladesh J. Zool.* **19(2)**: 229-235.
- Nuruzzaman, A.K.M. 1989. Socio-economic consideration of fish seed production in Bangladesh. Proceedings of the SAARC Workshop on Fish Seed Production, FRI, Mymensingh, Bangladesh. 60-70 pp.
- Padmakumar, K.G., Bindu, L., Sreerexha, P.S., Gopalakrishnan, A., Basheer, V.S., Nitta Joseph, Manu, P.S. and Anuradha Krishnan, 2011, Breeding of endemic catfish, *Horabagrus brachysoma* in captive conditions. *Current Science.* **100(8)**: 1232-1236.
- Parameswaran, S., Selvaraj, C. and Radhakrishnan, S. 1970. Observation on the maturation and breeding season of carps in Assam. *J. Inland Fish Soc. India.* **2**: 16-29.
- Parvin, S., Akteruzzaman, M., Akthar, P. and Alam, J., 2004 & 2005. Profitability and inequality of income from fish based farming systems in some areas of Mymensingh district. *Bangladesh J. Agri.* **29 & 30**: 91-95.

- Penman, D.J. and McAndrew, B.W. 1998. Practical aspects of selection and fitness of stocked fish. FAO-Fisheries Technical Paper No. 374: 223-233 pp.
- Pheleps, R.P. 2010. Recent Advances in Fish Hatchery Management. *R. Bras. Zootec.* **39**: 95-101.
- Puvaneswari, S., Marimuthu, K., Karuppasamy, R. and Haniffa, M.A.K. 2009. Early embryonic and larval development of Indian catfish, *Heteropnustes fossilis*. *Eur Asia J. Biosci.* **3**: 84-96.
- Quddus, M.A., 2007. Socio-economic study of pond fish production in selected areas of Bangladesh. *Bangladesh J. Agri.* **32(1)**: 63-69.
- Rahman, M.A. 1986. Socio-economic of aquaculture development, country paper Bangladesh. Paper presented at the workshop on socio-economic of aquaculture development, 28-31, October, Bangkok, Thailand.
- Rahman, M.A., Dewan, S., Rahmatullah, S.M. and Das Nityananda, 1985. Experiment on induced breeding of indigenous major carps by pituitary hormone injection. *Bangladesh J. Aquaculture.* **6-7(1)**: 51-57.
- Rahman, M.A., Uddin, K.M.A. and Zaher, M., 2005. Development of artificial breeding techniques for long whiskered catfish, *Sperata aor* and giant river catfish, *Sperata seenghala* of Bangladesh. *Bangladesh J. Fish. Res.* **9(1)**: 11-12.
- Rahman, M.F., Monoranjan, D., Somen, D. and Habib, A.B.M. 1988. Induced breeding of silver carp (*Hypophthalmichthys molitrix*). *Bangladesh J. Aquaculture*, **10(1)**: 35-41.
- Rahman, M.H., Hossain, M.A., Kawai, K. and Hossain, M.A. 1997. Morphometric characteristics and reproductive periodicity of freshwater fish, *Lepidocephalus guntea* (Hamilton). *Bull. Mar. Sci. Fish. Kochi Univ. Japan.* **No. 17**: 141-147.



- Rahman, S.S., Perschbacher, P., Hussain, M.G., Rahman, M. and Shah, M.S., 1987. A baseline survey of spawn buyers at the Freshwater Aquaculture Research Station hatchery, Mymensingh. *Bangladesh J. Fish.*, **10(1)**: 29-35.
- Rahmatullah, S.M., Islam, M.A., Hossain, M.M., Ali, M.M. and Islam, A.K.M.N. 1983. Experiment on the induced breeding of *Clarias batrachus* (Linn) by pituitary hormone injection. *Bangladesh J. Aq. Cult.* **2-5(1)**: 63-68.
- Rahmatullah, S.M., Rahman, M.M. and Ahmed, G.U., 2005. Reproductive biology, artificial propagation and larval rearing of two fresh water eels, *Monopterus couchia* and *Mastacembellus armatus*. *Bangladesh J. Fish. Res.* **9(1)**: 13-14.
- Ramaswami, L.S. and Sundararaj, B.I. 1957. Induced spawning of the catfish, *Clarias batrachus*, *Naturiss.* 44-48.
- Rao, G.R.M. and Janakiram, K. 1991. An effective dose of pituitary for breeding *Clarias* sp. *J. Aquac. Trop.* **6**: 207-210.
- Rashid, A.H.A., Rahman, M.S., Khan, M.M., Mian, S. and Rahman, T. 2009. Study on fish hatchery and nurseries in Mymensingh, Bangladesh. *Bangladesh J. Fish. Res.* **13(2)**: 147-152.
- Rothbard, S. 1981. Induced reproduction in cultivated cyprinids. The common carp and the group of chinese carps : Techniques of induction spawning and hatching. *Bamidgh.* **4**: 103-119.
- Royce, W.F. 1972. Introduction to the fishery science, Academic press, New York, San Francisco, London. P. 251.
- Rubbi, S.F., Rahman, M.M. and Jahan, A.K. 1987. Studies on proximate composition and quality of some commercial species of freshwater fish. *Bangladesh J. Sci. Res.* **5(1)**: 1-20.

- Saha, N.C., Alam, J., Al-Imran, M. and Islam, M.S. 2004. Comparative economic analysis of pond fish production in Mymensingh and Jessore districts, Bangladesh. *Bangladesh J. Fish. Res.* **8(2)**: 151-156.
- Sahoo, S.K., Giri, S.S., Chendra, S. and Mohapatra, B.C. 2008. Evaluation of breeding performance of Asian Catfish *Clarias batrachus* at different dose of HCG and latency period combinations. *Turkish Journal of Fisheries and Aquatic Sciences.* **8**: 249-251.
- Saidapur, S.K., Baharul Hoque and Pancharatna, K., 1997. Effect of pregnant mare serum gonadotrophin (PMSG), human chorionic gonadotrophin (HCG) and estradiol-17 $\beta$  (E<sub>2</sub>) on the oocyte recruitment and development in the sexually immature bull frog *Rana tigrina*. *J. Asiat. Soc. Bangladesh Sci.* **23(2)**: 297-304.
- Samad, R.A. 1968. Amadar Khadya drabbe pushti upadan (Nutrients in our diets), Text in Bengali, *Purogami Biggan* (P.C.S.I.R.Lb). **4(3)**: 323-334.
- Sardar, A.S., Azam, M.R. and Hossain, M.A. 2002. Private hatchery owner's prospective on hatchery management in Bangladesh. 77-81pp,
- Sarkar, M.R.U., Khan, S. and Haque, M.M. 2005. Production and economic return in pangasiid catfish (*Pangasius hypophthalmus*) monoculture and polyculture with silver carp (*Hypophthalmichthys molitrix*) in farmer's, ponds. *Bangladesh J. Fish. Res.*, **9(2)**, 111-126.
- Sarkar, U.K., Patiyal, R.S. and Srivastava, S.M. 2001. Successful induced spawning and hatching of hill stream carp, *Labeo dyocheilus* (McClelland) in kosi river. *Indian J. Fish.* **48(4)**: 413-416.
- Shahidullah, M. 1978. Preservation and transportation of fishes in Bangladesh. Fisheries Technological Research Station, Chandpur, Bangladesh 81-85 pp.
- Sharma, A.P. and Singh, V.K. 2002. Induced breeding responses of Indian major carps, viz. *Labeo rohita*, *Catla catla* and *Cirrhina mrigala* using ovaprim and carp pituitary extract. *Indian J. Animal Sci.* **72(4)**: 351-354.

- Sharma, K., Yadava, N.R. and Jindal, M. 2010. Effect of different doses of ovatide on the breeding performance of *Clarias batrachus* (Linn), *Livestock Research for Rural Development*. **22(4)**: 1-8.
- Shehadeh, Z.H. 1976. Induced breeding techniques-a review of progress and problems. Tech. Pap. 5, Workshop on Controlled Reproduction of Cultivated Fishes, Hamburg, 1973, 72-88.
- Siddique, K. and Chaudhuri, S. 1996. Fish culture Manuel. Published by National Institution of Local Govt. Agargaon, Dhaka, Bangladesh. 45p.
- Singh, R.K., Vartak, R., Vivek Balange, K. Amjad and G. Bhughuskar, M. Manoj. 2004. Water quality management during transportation of fry of Indian major carps, *Catla Catla* (Hamilton), *Labeo rohita* (Hamilton) and *Cirrhina mrigala* (Hamilton). *Aquaculture*, **235**: 297-302.
- Sinha, V.R.P. 1971. Induced spawning in carp with fractioned fish pituitary extract. *J. Fish. Biol. Lond.* **3**: 263-272.
- Sinha, V.R.P., Jhingran, V.G. and Ganapati, S.V. 1974. A review on spawning of the Indian major carps. *Arch. Hydrobiol.* **73**: 518-536.
- Steeby, J. and Avery, J. 2005. Channel catfish broodfish and hatchery management, *SRAC Publication No. 1803*. Southern Region Aquaculture.
- Stevens, R.E. 1966. Hormone-induced spawning of striped bass for reservoir stocking. *Prog. Fish. Cult.* **28**: 19-28.
- Talwar P.K. and Jhingran A.G. 1991. Inland fishes of India and Adjacent Countries, Oxford and IBH Publishing Co. Pvt. Ltd. Vol. **11**.
- Tang, Y.A., Hwang, Y.W. and Liu, C.K. 1963. Preliminary report on injection of pituitary hormone to induce spawning of Chinese carps. *Occ. Pap. Indo. Pacific Fish Coun.* **14**: 71pp.
- Thakur, N.K. 1976. On the spawning behaviour of *Clarias batrachus*. *Japanese Journal of Ichthyology*. **23(3)**: 178-180.

- Thakur, N.K. and Das, P. 1985. Synopsis on biological data on magur, *Clarias batrachus* (Linnaeus, 1758). Bull. No. 41, CIFRI, Barrackpore, India, 1-82.
- Thakur, N.K., Pal, R.N. and Khan, H.A. 1974. Embryonic and larval development of *Heteropneustes fossilis* (blotch). *J. Inland. Fish, Soc. India.* **6**: 33-44.
- Thirsted, S.H., Roos, N. and Hasan, N. 1997. The role of small indigenous fish species in food and nutrition security in Bangladesh. NAGA Newsletter, July-Dec. 13p.
- Tripathi, S.D. 1996. Present status of breeding and culture of catfishes in South Asia. *Aquat Living Resour.* **9**: 219-228.
- Uddin, M.S., Gupta, M.V. and Barua, G. 1988. Effects of fertilizers on the growth and survival of rohu (*Labeo rohita*) spawn in nursery ponds. *Bangladesh J. Fish.* **11(1)**: 83-88.
- Warner, G.F. and Domainieski, J.C.J. 1993. Fish farming and the environment. *Biologist*, London, **4&5**: 202-205.
- Wembiao Z., P. Jionghua and L. Wensheng, 1988. Culture of catfish in China. *Aquaculture*, **75**: 35-44.
- Woynarovich, E. and Horvath, L. 1980. The artificial propagation of warm water fin fishes A-manual for extension, *FAO Fish Tech. Pap. 1*: 183p.
- Zaman, T., Jewel, M.A.S. and Bhuiyan, A.S. 2006. Present status of pond fishery resources and livelihood of the fish farmers of Mohanpur Upazila in Rajshahi District. *Univ. J. Zool. Rajshahi Univ.* **25**: 31-35.

\* Not seen in original.

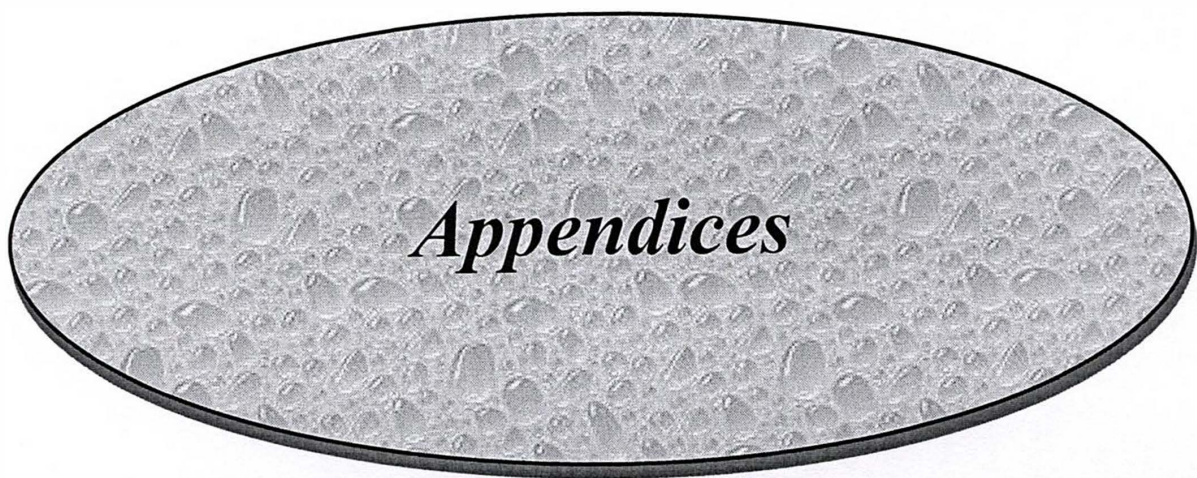

*Appendices*

### Appendix Table 1. Questionnaire for survey of fish hatcheries.

1. Name of the Hatchery:
2. Name of owner/owners:
3. Type of hatchery:  Govt.  Private  NGO
4. Address: Village: P.O.:  
Thana/Upazilla: District:
5. Occupation:  Hatchery Business  
 Hatchery Business & Others
6. Educational Status:  Illiterate  Primary School  
 High School  SSC  HSC  
 Graduate  Post-graduate
7. Training Status:  No training  Short term training  
 Consulting with UFO/DFO
8. Name of the Training:  In country  Abroad
9. Year of Establishment:
10. Source of fund:  Relatives  Money lender  
 Self  Self + Relatives  
 Bank loan  Mohazoni loan  
 Self + Relatives + Friends
11. Have you any transport?  Yes  No

#### 12. Employees of hatcheries:

Category	No.	Experience	Educational qualification	Temporary	Permanent	Training	Monthly salary	Daily salary
Officer								
Specialist								
Skilled								
Unskilled								

#### 13. Area of hatchery/hatcheries:

14. Number of ponds in the hatcheries:  Nursery  Rearing pond  
 Stocking pond

#### Depth of ponds:

#### 15. Physicochemical and biological characters of pond:

- Water Quality:  pH  CO<sub>2</sub>  
 DO

- Soil quality:  pH  Hardness  Alkalinity

- Diseases:  No disease  Seldom attack  
 Every year attack  Frequent attack

16. Category of land ownership:  Own  Leased  Both

17. Source of water supply:  Surface water  Underground water

#### 18. No. of overhead tank in the hatchery:

- Volume of overhead tank:  Length  Wide  Height

- Water capacity of overhead tank:

#### 19. No. of circular tank:

- Volume of circular tank:  Radius  Depth

20. No. of breeding tank:  Radius  Depth
21. No. of cistern/house:  
 Volume of house:  Length  Wide  Height
22. No. of Jars:  
 Volume of jars:  Radius  Depth
23. Chemical used for washing tank/house/bottles:
24. Source of brood fishes:
25. Supplementary feed used for brood fishes:  Rui  Catla  Mrigel  
 Silver carp  Grass carp  Punti  
 Bighead carp  Common carp  Bata  
 Calibaush
26. Stocking density of Brood fishes per decimal:  Rui  Catla  Mrigel  
 Silver carp  Grass carp  Punti  
 Bighead carp  Common carp  Bata  
 Calibaush
27. How many times the eggs are collected from the brood fishes:  Rui  Catla  Mrigel  
 Silver carp  Grass carp  Punti  
 Bighead carp  Common carp  Bata  
 Calibaush
28. Duration of conditioning of brood fishes:
29. What type of injection material is used:  PG  HCG  
 Ovaprim  LH

30. Quantity of spawn production:

Species	Spawn/kg	Species	Spawn/kg	Species	Spawn/kg
Rui		Silver carp		Pangus	
Catla		Common carp		Magur	
Mrigel		Mirror carp			
Calbaush		Grass carp			
Bata		Bighead carp			
Puti		Black carp			

31. Which is the most demandable species:  Spawn/Fry
32. Which species of fish fry you begin to produce and from which month?

Species	Starting (Month)	Peak Period	Ending (Month)
Rui			
Catla			
Mrigel			
Silver carp			
Grass carp			
Common carp			
Sarputi			
Thi-Pangas			
Calbasu			
Bighead carp			
Mirror carp			
Bata			

33. Marketing system:  Hatchery side  Local market  
 Country wide
34. Market price per kg:
35. Total income from spawn/fry:
36. Total expenditure:
37. Net total income:
38. Problems and constraints
- Faced by the owner kinds of problems:  Lack of technical knowledge  
 Insufficient water in dry season  
 Lack of fertilizer and chemical  
 Unavailability of feed  
 Disease  
 Lack of marketing facilities  
 Lack of credit  
 Leasing problem  
 Theft of fish  
 Poisoning in pond as enmity  
 Toll collection by terrorist  
 Joint partnership  
 Flood  
 Other natural calamity  
 Electricity



**Appendix Table 2.** Number, volume and water capacity of overhead tanks.

Sl. no. of hatcheries	No. of overhead tanks	Volume of overhead tank (m <sup>3</sup> )	Capacity (L)
1.	01	61.22	61,217.89
2.	01	73.47	73,474.87
3.	01	54.19	54,193.62
4.	01	34.33	34,330.80
5.	01	27.53	27,527.96
6.	01	30.01	30,006.14
7.	01	13.62	13,618.86
8.	01	49.03	49,027.90
9.	01	25.51	25,507.46
10.	01	13.25	13,249.81
11.	01	32.31	32,309.45
12.	01	46.26	46,259.48
13.	01	40.17	40,172.16
14.	01	35.67	35,665.79
15.	01	35.15	35,149.54
16.	01	27.95	27,945.81
17.	01	45.79	45,785.14
18	01	22.62	22,623.68
<b>Total</b>	<b>18</b>	<b>668.08</b>	<b>668066.36</b>
<b>Mean ± SD</b>	<b>1.00±0.00</b>	<b>37.12±15.78</b>	<b>37114.80±15782.35</b>

**Appendix Table 3.** Number, volume and water capacity of circular breeding tanks.

Sl. no. of hatcheries	No. of circular breeding tanks	Volume of circular breeding tanks (m <sup>3</sup> )	Capacity circular breeding tanks (L)
1	01	12.812	12811.90
6	01	6.673	6672.86
8	01	4.504	4504.18
14	01	3.270	3269.70
<b>Total</b>	<b>04</b>	<b>27.259</b>	<b>272583.64</b>
<b>Mean±SD</b>		<b>6.81±4.24</b>	<b>6814.66±4238.40</b>

**Appendix Table 4.** Number, volume and water capacity of circular hatching tanks.

Sl. No. of hatcheries	No. of circular tanks	Volume of each circular tank (m <sup>3</sup> )	Total volume (m <sup>3</sup> )	Water carrying capacity of each circular tank (L)	Total water carrying capacity (L)
1	03	10.767	32.301	10675.560	32301
2	03	11.210	33.630	11210.410	33630
4	01	4.504	4.504	4504.180	4504
6	02	3.270	6.540	3269.700	6540
9	01	9.609	9.609	9608.930	9609
12	03	6.673	20.019	6672.860	20019
15	01	5.694	5.694	5694.180	5694
18	02	3.559	7.118	3558.860	7118
<b>Total</b>	<b>16</b>	<b>55.286</b>	<b>119.415</b>	<b>55194.68</b>	<b>119415</b>
<b>Mean±SD</b>	<b>2.00±0.93</b>	<b>6.91±3.22</b>	<b>14.93±12.14</b>	<b>6899.34±3201.80</b>	<b>14926.88±12136.59</b>

**Appendix Table 5.** Number, volume, total volume and water capacity of houses or cisterns.

SL. No. of hatcheries	No. of cisterns	Volume of each cistern (m <sup>3</sup> )	Total volume of cistern (m <sup>3</sup> )	Total water carrying capacity (L)
1	05	3.38	16.90	16,875.05
2	08	2.82	22.56	22,549.52
3	06	2.82	16.92	16,912.14
4	05	3.38	16.90	16,875.05
5	05	2.36	11.80	11,823.05
6	06	2.88	17.28	17,252.52
7	06	3.12	18.72	18,692.34
8	06	3.12	18.72	18,692.34
9	03	3.38	10.14	10,125.03
10	04	4.06	16.24	16,253.32
11	12	3.38	40.56	40,500.12
12	08	3.50	28.00	27,987.44
13	04	3.81	15.24	15,243.16
14	06	3.36	20.16	20,188.38
15	13	3.38	43.94	43,940.00
16	07	3.52	24.64	24,640.00
17	06	1.73	10.38	10,392.72
18	06	2.26	13.56	13,574.22
<b>Total</b>	<b>116</b>	<b>56.26</b>	<b>362.66</b>	<b>362516.40</b>
<b>Mean ± SD</b>	<b>6.44±2.55</b>	<b>3.13±0.57</b>	<b>20.15±9.27</b>	<b>20139.80±9265.87</b>

**Appendix Table 6.** The number, volume, total volume, capacity of each jar and total water carrying capacity of jar/bottles.

SL. No. of hatcheries	No. of jars	Volume of each jar (m <sup>3</sup> )	Total volume of jars (m <sup>3</sup> )	Water carrying capacity of each jar (L)	Total water carrying capacity of jars (L)
1	10	0.556	5.560	556.07	5560.70
2	13	0.556	7.228	556.07	7228.91
3	11	0.487	5.357	486.56	5352.16
4	09	0.556	5.004	556.07	5004.63
5	08	0.801	6.408	800.74	6405.92
6	19	0.424	8.056	423.85	8053.15
7	13	0.556	7.228	556.07	7228.91
8	12	0.356	4.272	355.89	4270.68
9	08	0.484	3.872	484.40	3875.20
10	04	0.323	1.292	322.93	1291.72
11	13	0.424	5.512	423.85	5510.05
12	10	0.487	4.870	486.56	4865.60
13	08	0.487	3.896	486.56	3892.48
14	08	0.323	2.584	322.93	2583.44
15	12	0.556	6.672	556.07	6672.84
16	10	0.556	5.560	556.07	5560.70
17	09	0.487	4.383	486.56	4389.04
18	12	0.500	6.000	500.46	6005.52
<b>Total</b>	<b>189</b>	<b>8.919</b>	<b>93.754</b>	<b>8917.71</b>	<b>93751.65</b>
<b>Mean ± SD</b>	<b>10.50± 3.17</b>	<b>0.50± 0.11</b>	<b>5.21± 1.69</b>	<b>495.43 ± 109.80</b>	<b>5208.43 ± 1685.25</b>

**Appendix Table 7.** ANOVA table for egg release of *C. batrachus* under different doses of PG in the month of April, 2010.

Source of Variation	SS	df	MS	F	P-value	F crit
Rows	26666.67	4	6666.667	10**	0.003344	3.837853
Columns	1333.333	2	666.6667	1	0.4096	4.45897
Error	5333.333	8	666.6667			
Total	33333.33	14				

**Appendix Table 8.** ANOVA table for egg release of *C. batrachus* under different doses of PG in the month of May, 2010 .

Source of Variation	SS	df	MS	F	P-value	F crit
Rows	4000	4	1000	1**	0.460905	3.837853
Columns	5333.333	2	2666.667	2.666667	0.1296	4.45897
Error	8000	8	1000			
Total	17333.33	14				

**Appendix Table 9.** ANOVA table for egg release of *C. batrachus* under different doses of PG in the month of June, 2010.

Source of Variation	SS	df	MS	F	P-value	F crit
Rows	2666.667	4	666.6667	1**	0.460905	3.837853
Columns	1333.333	2	666.6667	1	0.4096	4.45897
Error	5333.333	8	666.6667			
Total	9333.333	14				

**Appendix Table 10.** ANOVA table for egg release of *C. batrachus* under different doses of PG in the month of July, 2010.

Source of Variation	SS	df	MS	F	P-value	F crit
Rows	4000	4	1000	1**	0.460905	3.837853
Columns	5333.333	2	2666.667	2.666667	0.1296	4.45897
Error	8000	8	1000			
Total	17333.33	14				

\*\*\* = very significant; \*\* = significant; \* = insignificant

**Appendix Table 11.** ANOVA table for fertilization of *C. batrachus* under different doses of PG in the month of April, 2010.

Source of Variation	SS	df	MS	F	P-value	F crit
Rows	17136.85	4	4284.213	17.35031**	0.000523	3.837853
Columns	489.2838	2	244.6419	0.990756	0.412643	4.45897
Error	1975.395	8	246.9244			
Total	19601.53	14				

**Appendix Table 12.** ANOVA table for fertilization of *C. batrachus* under different doses of PG in the month of May, 2010 .

Source of Variation	SS	df	MS	F	P-value	F crit
Rows	12392.56	4	3098.141	11.63332**	0.002044	3.837853
Columns	793.5633	2	396.7816	1.48989	0.281829	4.45897
Error	2130.528	8	266.316			
Total	15316.65	14				

**Appendix Table 13.** ANOVA table for fertilization of *C. batrachus* under different doses of PG in the month of June, 2010.

Source of Variation	SS	df	MS	F	P-value	F crit
Rows	8768.375	4	2192.094	41.32278***	2.19E-05	3.837853
Columns	115.1837	2	57.59186	1.085654	0.382695	4.45897
Error	424.3845	8	53.04807			
Total	9307.943	14				

**Appendix Table 14.** ANOVA table for fertilization of *C. batrachus* under different doses of PG in the month of July, 2010.

Source of Variation	SS	df	MS	F	P-value	F crit
Rows	9229.058	4	2307.264	8.609802**	0.005361	3.837853
Columns	1166.508	2	583.2542	2.176475	0.175905	4.45897
Error	2143.849	8	267.9811			
Total	12539.41	14				

\*\*\* = very significant; \*\* = significant; \* = insignificant

**Appendix Table 15.** ANOVA table for hatching of *C. batrachus* under different doses of PG in the month of April, 2010.

Source of Variation	SS	df	MS	F	P-value	F crit
Rows	14853.77	4	3713.442	18.59525**	0.00041	3.837853
Columns	366.1503	2	183.0752	0.916758	0.438051	4.45897
Error	1597.588	8	199.6985			
Total	16817.51	14				

**Appendix Table 16.** ANOVA table for hatching of *C. batrachus* under different doses of PG in the month of May, 2010 .

Source of Variation	SS	df	MS	F	P-value	F crit
Rows	11041.93	4	2760.484	12.92141**	0.001441	3.837853
Columns	604.8145	2	302.4073	1.415523	0.297631	4.45897
Error	1709.091	8	213.6364			
Total	13355.84	14				

**Appendix Table 17.** ANOVA table for hatching of *C. batrachus* under different doses of PG in the month of June, 2010.

Source of Variation	SS	df	MS	F	P-value	F crit
Rows	8561.847	4	2140.462	88.71811***	1.16E-06	3.837853
Columns	47.64916	2	23.82458	0.987484	0.413727	4.45897
Error	193.0124	8	24.12655			
Total	8802.508	14				

**Appendix Table 18.** ANOVA table for hatching of *C. batrachus* under different doses of PG in the month of July, 2010.

Source of Variation	SS	df	MS	F	P-value	F crit
Rows	9178.673	4	2294.668	12.72769**	0.001516	3.837853
Columns	671.8214	2	335.9107	1.863175	0.216625	4.45897
Error	1442.315	8	180.2894			
Total	11292.81	14				

\*\*\* = very significant; \*\* = significant; \* = insignificant

**Appendix Table 19.** ANOVA table for survivability of *C. batrachus* under different doses of PG in the month of April, 2010.

Source of Variation	SS	df	MS	F	P-value	F crit
Rows	16555.05	4	4138.762	11.85947**	0.001918	3.837853
Columns	693.4336	2	346.7168	0.993505	0.411735	4.45897
Error	2791.869	8	348.9836			
Total	20040.35	14				

**Appendix Table 20.** ANOVA table for survivability of *C. batrachus* under different doses of PG in the month of May, 2010 .

Source of Variation	SS	df	MS	F	P-value	F crit
Rows	7548.197	4	1887.049	3.156953**	0.078019	3.837853
Columns	1992.469	2	996.2345	1.666658	0.248274	4.45897
Error	4781.951	8	597.7438			
Total	14322.62	14				

**Appendix Table 21.** ANOVA table for survivability of *C. batrachus* under different doses of PG in the month of June, 2010.

Source of Variation	SS	df	MS	F	P-value	F crit
Rows	2461.478	4	615.3695	2.001357**	0.187288	3.837853
Columns	743.8834	2	371.9417	1.209661	0.347538	4.45897
Error	2459.809	8	307.4761			
Total	5665.17	14				

**Appendix Table 22.** ANOVA table for survivability of *C. batrachus* under different doses of PG in the month of July, 2010.

Source of Variation	SS	df	MS	F	P-value	F crit
Rows	3350.712	4	837.6781	1.680814**	0.246379	3.837853
Columns	2485.541	2	1242.77	2.493637	0.143975	4.45897
Error	3987.012	8	498.3766			
Total	9823.266	14				

\*\*\* = very significant; \*\* = significant; \* = insignificant



**Appendix Table 23.** ANOVA table for egg release of *C. batrachus* under different doses of PG in the month of April, 2011.

Source of Variation	SS	df	MS	F	P-value	F crit
Rows	26666.67	4	6666.667	10**	0.003344	3.837853
Columns	1333.333	2	666.6667	1	0.4096	4.45897
Error	5333.333	8	666.6667			
Total	33333.33	14				

**Appendix Table 24.** ANOVA table for egg release of *C. batrachus* under different doses of PG in the month of May, 2011.

Source of Variation	SS	df	MS	F	P-value	F crit
Rows	10666.67	4	2666.667	2.285714**	0.148605	3.837853
Columns	4000	2	2000	1.714286	0.2401	4.45897
Error	9333.333	8	1166.667			
Total	24000	14				

**Appendix Table 25.** ANOVA table for egg release of *C. batrachus* under different doses of PG in the month of June, 2011.

Source of Variation	SS	df	MS	F	P-value	F crit
Rows	2666.667	4	666.6667	1**	0.460905	3.837853
Columns	1333.333	2	666.6667	1	0.4096	4.45897
Error	5333.333	8	666.6667			
Total	9333.333	14				

**Appendix Table 26.** ANOVA table for egg release of *C. batrachus* under different doses of PG in the month of July, 2011.

Source of Variation	SS	df	MS	F	P-value	F crit
Rows	2666.667	4	666.6667	1	0.460905	3.837853
Columns	1333.333	2	666.6667	1	0.4096	4.45897
Error	5333.333	8	666.6667			
Total	9333.333	14				

\*\*\* = very significant; \*\* = significant; \* = insignificant

**Appendix Table 27.** ANOVA table for fertilization of *C. batrachus* under different doses of PG in the month of April, 2011.

Source of Variation	SS	df	MS	F	P-value	F crit
Rows	21047.64	4	5261.909	706.8862***	3.16E-10	3.837853
Columns	28.55092	2	14.27546	1.917769	0.208741	4.45897
Error	59.55028	8	7.443785			
Total	21135.74	14				

**Appendix Table 28.** ANOVA table for fertilization of *C. batrachus* under different doses of PG in the month of May, 2011.

Source of Variation	SS	df	MS	F	P-value	F crit
Rows	11686.71	4	2921.677	9.690016**	0.003697	3.837853
Columns	701.3658	2	350.6829	1.163073	0.360252	4.45897
Error	2412.113	8	301.5141			
Total	14800.19	14				

**Appendix Table 29.** ANOVA table for fertilization of *C. batrachus* under different doses of PG in the month of June, 2011.

Source of Variation	SS	df	MS	F	P-value	F crit
Rows	17136.85	4	4284.213	17.35031**	0.000523	3.837853
Columns	489.2838	2	244.6419	0.990756	0.412643	4.45897
Error	1975.395	8	246.9244			
Total	19601.53	14				

**Appendix Table 30.** ANOVA table for fertilization of *C. batrachus* under different doses of PG in the month of July, 2011.

Source of Variation	SS	df	MS	F	P-value	F crit
Rows	8450.466	4	2112.617	40.4603***	2.37E-05	3.837853
Columns	68.55652	2	34.27826	0.656489	0.54451	4.45897
Error	417.7165	8	52.21456			
Total	8936.739	14				

\*\*\* = very significant; \*\* = significant; \* = insignificant

**Appendix Table 31.** ANOVA table for hatching of *C. batrachus* under different doses of PG in the month of April, 2011.

Source of Variation	SS	df	MS	F	P-value	F crit
Rows	18356.55	4	4589.137	669.3594***	3.93E-10	3.837853
Columns	3.192893	2	1.596447	0.232853	0.797457	4.45897
Error	54.84811	8	6.856013			
Total	18414.59	14				

**Appendix Table 32.** ANOVA table for hatching of *C. batrachus* under different doses of PG in the month of May, 2011.

Source of Variation	SS	df	MS	F	P-value	F crit
Rows	10804.26	4	2701.066	14.18059**	0.001052	3.837853
Columns	780.1191	2	390.0595	2.047812	0.191358	4.45897
Error	1523.81	8	190.4762			
Total	13108.19	14				

**Appendix Table 33.** ANOVA table for hatching of *C. batrachus* under different doses of PG in the month of June, 2011.

Source of Variation	SS	df	MS	F	P-value	F crit
Rows	8599.237	4	2149.809	79.4349***	1.78E-06	3.837853
Columns	80.68249	2	40.34125	1.490599	0.281683	4.45897
Error	216.5103	8	27.06379			
Total	8896.43	14				

**Appendix Table 34.** ANOVA table for hatching of *C. batrachus* under different doses of PG in the month of July, 2011.

Source of Variation	SS	df	MS	F	P-value	F crit
Rows	7828.682	4	1957.17	84.30105***	1.42E-06	3.837853
Columns	59.45125	2	29.72563	1.28037	0.329293	4.45897
Error	185.7315	8	23.21644			
Total	8073.865	14				

\*\*\* = very significant; \*\* = significant; \* = insignificant

**Appendix Table 35.** ANOVA table for survivability of *C. batrachus* under different doses of PG in the month of April, 2011.

Source of Variation	SS	df	MS	F	P-value	F crit
Rows	20918.94	4	5229.736	773.0795***	2.21E-10	3.837853
Columns	11.06965	2	5.534827	0.818179	0.475016	4.45897
Error	54.11848	8	6.76481			
Total	20984.13	14				

**Appendix Table 36.** ANOVA table for survivability of *C. batrachus* under different doses of PG in the month of May, 2011.

Source of Variation	SS	df	MS	F	P-value	F crit
Rows	7408.039	4	1852.01	3.331408**	0.069303	3.837853
Columns	1932.14	2	966.0699	1.737773	0.236193	4.45897
Error	4447.392	8	555.924			
Total	13787.57	14				

**Appendix Table 37.** ANOVA table for survivability of *C. batrachus* under different doses of PG in the month of June, 2011.

Source of Variation	SS	df	MS	F	P-value	F crit
Rows	1423.615	4	355.9036	0.765205*	0.576575	3.837853
Columns	1272.018	2	636.0091	1.367441	0.30844	4.45897
Error	3720.871	8	465.1089			
Total	6416.504	14				

**Appendix Table 38.** ANOVA table for survivability of *C. batrachus* under different doses of PG in the month of July, 2011.

Source of Variation	SS	df	MS	F	P-value	F crit
Rows	2113.372	4	528.3429	1.662476**	0.250383	3.837853
Columns	599.0861	2	299.543	0.942538	0.428983	4.45897
Error	2542.438	8	317.8048			
Total	5254.896	14				

\*\*\* = very significant; \*\* = significant; \* = insignificant

**Appendix Table 39.** ANOVA table for egg release of *C. batrachus* under different doses of HCG in the month of April, 2010.

Source of Variation	SS	df	MS	F	P-value	F crit
Rows	22666.67	4	5666.667	4.857143**	0.027741	3.837853
Columns	4000	2	2000	1.714286	0.2401	4.45897
Error	9333.333	8	1166.667			
Total	36000	14				

**Appendix Table 40.** ANOVA table for egg release of *C. batrachus* under different doses of HCG in the month of May, 2010.

Source of Variation	SS	df	MS	F	P-value	F crit
Rows	26666.67	4	6666.667	10**	0.003344	3.837853
Columns	1333.333	2	666.6667	1	0.4096	4.45897
Error	5333.333	8	666.6667			
Total	33333.33	14				

**Appendix Table 41.** ANOVA table for egg release of *C. batrachus* under different doses of HCG in the month of June, 2010.

Source of Variation	SS	df	MS	F	P-value	F crit
Rows	22666.67	4	5666.667	8.5**	0.005579	3.837853
Columns	1333.333	2	666.6667	1	0.4096	4.45897
Error	5333.333	8	666.6667			
Total	29333.33	14				

**Appendix Table 42.** ANOVA table for egg release of *C. batrachus* under different doses of HCG in the month of July, 2010.

Source of Variation	SS	df	MS	F	P-value	F crit
Rows	22666.67	4	5666.667	4.857143**	0.027741	3.837853
Columns	4000	2	2000	1.714286	0.2401	4.45897
Error	9333.333	8	1166.667			
Total	36000	14				

\*\*\* = very significant; \*\* = significant; \* = insignificant

**Appendix Table 43.** ANOVA table for fertilization of *C. batrachus* under different doses of HCG in the month of April, 2010.

Source of Variation	SS	df	MS	F	P-value	F crit
Rows	15485.8	4	3871.45	10.10095**	0.003238	3.837853
Columns	1257.786	2	628.893	1.640836	0.252852	4.45897
Error	3066.208	8	383.2759			
Total	19809.79	14				

**Appendix Table 44.** ANOVA table for fertilization of *C. batrachus* under different doses of HCG in the month of May, 2010.

Source of Variation	SS	df	MS	F	P-value	F crit
Rows	17247.3	4	4311.825	37.28645***	3.22E-05	3.837853
Columns	175.2822	2	87.64109	0.757875	0.49956	4.45897
Error	925.1243	8	115.6405			
Total	18347.71	14				

**Appendix Table 45.** ANOVA table for fertilization of *C. batrachus* under different doses of HCG in the month of June, 2010.

Source of Variation	SS	df	MS	F	P-value	F crit
Rows	15481.23	4	3870.307	36.11029***	3.63E-05	3.837853
Columns	268.324	2	134.162	1.251743	0.336532	4.45897
Error	857.4413	8	107.1802			
Total	16606.99	14				

**Appendix Table 46.** ANOVA table for fertilization of *C. batrachus* under different doses of HCG in the month of July, 2010.

Source of Variation	SS	df	MS	F	P-value	F crit
Rows	15475.53	4	3868.883	9.962108**	0.003385	3.837853
Columns	1144.871	2	572.4357	1.473982	0.285119	4.45897
Error	3106.879	8	388.3599			
Total	19727.28	14				

\*\*\* = very significant; \*\* = significant; \* = insignificant

**Appendix Table 47.** ANOVA table for hatching of *C. batrachus* under different doses of HCG in the month of April, 2010.

Source of Variation	SS	df	MS	F	P-value	F crit
Rows	12692.73	4	3173.182	11.86522**	0.001915	3.837853
Columns	796.7946	2	398.3973	1.489695	0.281869	4.45897
Error	2139.484	8	267.4355			
Total	15629.01	14				

**Appendix Table 48.** ANOVA table for hatching of *C. batrachus* under different doses of HCG in the month of May, 2010.

Source of Variation	SS	df	MS	F	P-value	F crit
Rows	13594.57	4	3398.643	41.02009***	2.25E-05	3.837853
Columns	229.3502	2	114.6751	1.384077	0.304646	4.45897
Error	662.825	8	82.85312			
Total	14486.75	14				

**Appendix Table 49.** ANOVA table for hatching of *C. batrachus* under different doses of HCG in the month of June, 2010.

Source of Variation	SS	df	MS	F	P-value	F crit
Rows	12062.36	4	3015.59	35.4987***	3.87E-05	3.837853
Columns	183.3308	2	91.66538	1.07906	0.384686	4.45897
Error	679.5944	8	84.9493			
Total	12925.28	14				

**Appendix Table 50.** ANOVA table for hatching of *C. batrachus* under different doses of HCG in the month of July, 2010.

Source of Variation	SS	df	MS	F	P-value	F crit
Rows	13027.58	4	3256.894	12.53033**	0.001597	3.837853
Columns	782.8532	2	391.4266	1.505945	0.278556	4.45897
Error	2079.367	8	259.9208			
Total	15889.8	14				

\*\*\* = very significant; \*\* = significant; \* = insignificant

**Appendix Table 51.** ANOVA table for survivability of *C. batrachus* under different doses of HCG in the month of April, 2010.

Source of Variation	SS	df	MS	F	P-value	F crit
Rows	12619.04	4	3154.76	6.229619**	0.01405	3.837853
Columns	1869.848	2	934.9242	1.84617	0.219156	4.45897
Error	4051.304	8	506.413			
Total	18540.19	14				

**Appendix Table 52.** ANOVA table for survivability of *C. batrachus* under different doses of HCG in the month of May, 2010.

Source of Variation	SS	df	MS	F	P-value	F crit
Rows	15088.6	4	3772.15	14.06018**	0.001083	3.837853
Columns	456.8723	2	228.4362	0.851465	0.462113	4.45897
Error	2146.288	8	268.286			
Total	17691.76	14				

**Appendix Table 53.** ANOVA table for survivability of *C. batrachus* under different doses of HCG in the month of June, 2010.

Source of Variation	SS	df	MS	F	P-value	F crit
Rows	12694.34	4	3173.586	11.97583**	0.001857	3.837853
Columns	442.0719	2	221.0359	0.8341	0.468789	4.45897
Error	2119.994	8	264.9993			
Total	15256.41	14				

**Appendix Table 54.** ANOVA table for survivability of *C. batrachus* under different doses of HCG in the month of July, 2010.

Source of Variation	SS	df	MS	F	P-value	F crit
Rows	12785.19	4	3196.297	6.643395**	0.01168	3.837853
Columns	1933.799	2	966.8995	2.009668	0.196263	4.45897
Error	3848.992	8	481.124			
Total	18567.98	14				

\*\*\* = very significant; \*\* = significant; \* = insignificant



**Appendix Table 55.** ANOVA table for egg release of *C. batrachus* under different doses of HCG in the month of April, 2011.

Source of Variation	SS	df	MS	F	P-value	F crit
Rows	24000	4	6000	6**	0.015625	3.837853
Columns	5333.333	2	2666.667	2.666667	0.1296	4.45897
Error	8000	8	1000			
Total	37333.33	14				

**Appendix Table 56.** ANOVA table for egg release of *C. batrachus* under different doses of HCG in the month of May, 2011.

Source of Variation	SS	df	MS	F	P-value	F crit
Rows	22666.67	4	5666.667	8.5**	0.005579	3.837853
Columns	1333.333	2	666.6667	1	0.4096	4.45897
Error	5333.333	8	666.6667			
Total	29333.33	14				

**Appendix Table 57.** ANOVA table for egg release of *C. batrachus* under different doses of HCG in the month of June, 2011.

Source of Variation	SS	df	MS	F	P-value	F crit
Rows	22666.67	4	5666.667	8.5**	0.005579	3.837853
Columns	1333.333	2	666.6667	1	0.4096	4.45897
Error	5333.333	8	666.6667			
Total	29333.33	14				

**Appendix Table 58.** ANOVA table for egg release of *C. batrachus* under different doses of HCG in the month of July, 2011.

Source of Variation	SS	df	MS	F	P-value	F crit
Rows	20000	4	5000	3.333333**	0.069214	3.837853
Columns	1333.333	2	666.6667	0.444444	0.6561	4.45897
Error	12000	8	1500			
Total	33333.33	14				

\*\*\* = very significant; \*\* = significant; \* = insignificant

**Appendix Table 59.** ANOVA table for fertilization of *C. batrachus* under different doses of HCG in the month of April, 2011.

Source of Variation	SS	df	MS	F	P-value	F crit
Rows	16997.61	4	4249.401	13.50336**	0.001242	3.837853
Columns	1500.179	2	750.0895	2.383566	0.154165	4.45897
Error	2517.538	8	314.6922			
Total	21015.32	14				

**Appendix Table 60.** ANOVA table for fertilization of *C. batrachus* under different doses of HCG in the month of May, 2011.

Source of Variation	SS	df	MS	F	P-value	F crit
Rows	15433.47	4	3858.367	36.03088***	3.66E-05	3.837853
Columns	206.1155	2	103.0577	0.962392	0.422159	4.45897
Error	856.68	8	107.085			
Total	16496.26	14				

**Appendix Table 61.** ANOVA table for fertilization of *C. batrachus* under different doses of HCG in the month of June, 2011.

Source of Variation	SS	df	MS	F	P-value	F crit
Rows	14943.02	4	3735.755	26.11884**	0.000121	3.837853
Columns	135.8453	2	67.92266	0.474887	0.638428	4.45897
Error	1144.233	8	143.0291			
Total	16223.1	14				

**Appendix Table 62.** ANOVA table for fertilization of *C. batrachus* under different doses of HCG in the month of July, 2011.

Source of Variation	SS	df	MS	F	P-value	F crit
Rows	13000.06	4	3250.014	7.563855**	0.007962	3.837853
Columns	590.7514	2	295.3757	0.687437	0.530271	4.45897
Error	3437.415	8	429.6769			
Total	17028.22	14				

\*\*\* = very significant; \*\* = significant; \* = insignificant

**Appendix Table 63.** ANOVA table for hatching of *C. batrachus* under different doses of HCG in the month of April, 2011.

Source of Variation	SS	df	MS	F	P-value	F crit
Rows	13763.56	4	3440.89	16.65733**	0.000604	3.837853
Columns	1254.961	2	627.4803	3.037628	0.10436	4.45897
Error	1652.553	8	206.5692			
Total	16671.07	14				

**Appendix Table 64.** ANOVA table for hatching of *C. batrachus* under different doses of HCG in the month of May, 2011.

Source of Variation	SS	df	MS	F	P-value	F crit
Rows	11535.57	4	2883.893	26.31475**	0.000117	3.837853
Columns	120.7753	2	60.38765	0.551021	0.596767	4.45897
Error	876.7381	8	109.5923			
Total	12533.08	14				

**Appendix Table 65.** ANOVA table for hatching of *C. batrachus* under different doses of HCG in the month of June, 2011.

Source of Variation	SS	df	MS	F	P-value	F crit
Rows	12187.34	4	3046.835	33.69244***	4.71E-05	3.837853
Columns	225.1566	2	112.5783	1.244911	0.338289	4.45897
Error	723.4466	8	90.43082			
Total	13135.94	14				

**Appendix Table 66.** ANOVA table for hatching of *C. batrachus* under different doses of HCG in the month of July, 2011.

Source of Variation	SS	df	MS	F	P-value	F crit
Rows	11777.82	4	2944.456	10.43801**	0.002913	3.837853
Columns	394.3988	2	197.1994	0.699066	0.525042	4.45897
Error	2256.719	8	282.0898			
Total	14428.94	14				

\*\*\* = very significant; \*\* = significant; \* = insignificant

**Appendix Table 67.** ANOVA table for survivability of *C. batrachus* under different doses of HCG in the month of April, 2011.

Source of Variation	SS	df	MS	F	P-value	F crit
Rows	14307.82	4	3576.955	8.046749**	0.006602	3.837853
Columns	2311.593	2	1155.797	2.60009	0.134909	4.45897
Error	3556.174	8	444.5217			
Total	20175.59	14				

**Appendix Table 68.** ANOVA table for survivability of *C. batrachus* under different doses of HCG in the month of May, 2011.

Source of Variation	SS	df	MS	F	P-value	F crit
Rows	14127.84	4	3531.959	11.88661**	0.001903	3.837853
Columns	373.6907	2	186.8454	0.628818	0.557647	4.45897
Error	2377.1	8	297.1375			
Total	16878.63	14				

**Appendix Table 69.** ANOVA table for survivability of *C. batrachus* under different doses of HCG in the month of June, 2011.

Source of Variation	SS	df	MS	F	P-value	F crit
Rows	11760.45	4	2940.113	10.07035**	0.003269	3.837853
Columns	372.5516	2	186.2758	0.638024	0.553233	4.45897
Error	2335.66	8	291.9575			
Total	14468.66	14				

**Appendix Table 70.** ANOVA table for survivability of *C. batrachus* under different doses of HCG in the month of July, 2011.

Source of Variation	SS	df	MS	F	P-value	F crit
Rows	10947.26	4	2736.815	4.45172**	0.034722	3.837853
Columns	495.2763	2	247.6381	0.40281	0.681272	4.45897
Error	4918.214	8	614.7768			
Total	16360.75	14				

\*\*\* = very significant; \*\* = significant; \* = insignificant

Rajshahi University Library

Accession No.: D-3628

Date: 14/9/2014

Price: Gist

Source: COE, R.U.