

University of Rajshahi

Rajshahi-6205

Bangladesh.

RUCL Institutional Repository

<http://rulrepository.ru.ac.bd>

Institute of Biological Sciences (IBSc)

PhD Thesis

2013

Diagnostic laboratory tests for visceral leishmaniasis and exploration of genotype and genetic diversity of *Leishmania donovani* isolates from kalaazar patients

Salam, Md. Abdus

University of Rajshahi

<http://rulrepository.ru.ac.bd/handle/123456789/631>

Copyright to the University of Rajshahi. All rights reserved. Downloaded from RUCL Institutional Repository.

PhD
Thesis

**DIAGNOSTIC LABORATORY TESTS FOR VISCERAL
LEISHMANIASIS AND EXPLORATION OF GENOTYPE
AND GENETIC DIVERSITY OF THE *LEISHMANIA
DONOVANI* ISOLATES FROM KALA AZAR PATIENTS**

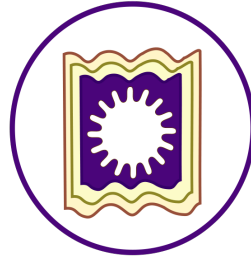

THESIS SUBMITTED FOR THE DEGREE
OF
DOCTOR OF PHILOSOPHY
IN THE
INSTITUTE OF BIOLOGICAL SCIENCES
UNIVERSITY OF RAJSHAHI, RAJSHAHI-6205
BANGLADESH

By

Md. Abdus Salam

MBBS, MSc, MPhil

July, 2013

**July
2013**

**Parasitology Laboratory,
International Centre for Diarrhoeal
Disease Research (ICDDR,B), Dhaka,
Bangladesh**

**Institute of Biological Sciences
University of Rajshahi
Rajshahi-6205
Bangladesh**

**DIAGNOSTIC LABORATORY TESTS FOR VISCERAL
LEISHMANIASIS AND EXPLORATION OF GENOTYPE
AND GENETIC DIVERSITY OF THE *LEISHMANIA
DONOVANI* ISOLATES FROM KALA AZAR PATIENTS**

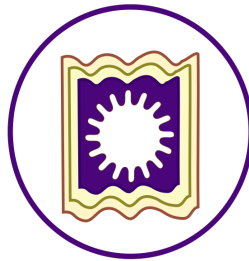

THESIS SUBMITTED FOR THE DEGREE
OF
DOCTOR OF PHILOSOPHY
IN THE
INSTITUTE OF BIOLOGICAL SCIENCES
UNIVERSITY OF RAJSHAHI, RAJSHAHI-6205
BANGLADESH

By

Md. Abdus Salam

MBBS, MSc, MPhil

July, 2013

**Parasitology Laboratory,
International Centre for Diarrhoeal
Disease Research (ICDDR,B), Dhaka,
Bangladesh**

**Institute of Biological Sciences
University of Rajshahi
Rajshahi-6205
Bangladesh**

DECLARATION

I the undersigned hereby solemnly declare that the entire works submitted in the thesis titled “**Diagnostic laboratory tests for visceral leishmaniasis and exploration of genotype and genetic diversity of *Leishmania donovani* isolates from kala azar patients**” to the Institute of Biological Sciences (IBSc), University of Rajshahi, Bangladesh for the degree of Doctor of Philosophy is the result of the original investigation carried out by me. This work was supervised by Professor M. Khalequzzaman, Department of Zoology, University of Rajshahi and co-supervised by Dr. Dinesh Mondal, Senior Scientist, Parasitology Laboratory of ICDDR,B, Dhaka, Bangladesh. Protocol of this research was approved by the Institutional Animal, Medical Ethics, Biosafety and Biosecurity Committee (IAMEBBC) of IBSc and rigorous ethical practices were followed all through for protection of human rights and standard laboratory practices. I further declare that this thesis has not been submitted elsewhere for any other degree.

July, 2013
Rajshahi

Md. Abdus Salam

CERTIFICATE

This is to certify that **Md. Abdus Salam**, is the sole author of the thesis entitled **“Diagnostic laboratory tests for visceral leishmaniasis and exploration of genotype and genetic diversity of *Leishmania donovani* isolates from kala azar patients”**. This thesis or part thereof has not been previously submitted for the award of any degree, diploma, or associateship of any other similar title.

I am forwarding this thesis to be examined for the degree of Doctor of Philosophy (PhD) to the Institute of Biological Sciences (IBSc), the University of Rajshahi, Bangladesh. Md. Abdus Salam has fulfilled all the requirements according to the rules of the University of Rajshahi for submission of a thesis for PhD degree.

Supervisor

July, 2013
Rajshahi

Professor Dr. M. Khalequzzaman
Professor
Department of Zoology
University of Rajshahi
Rajshahi-6205
Bangladesh

***DEDICATED
TO
MY PARENTS & FAMILY***

ACKNOWLEDGEMENTS

I would like to express my deepest sense of gratitude and respect to my supervisor Prof. Dr. M. Khalequzzaman, Professor, Department of Zoology and former Director, Institute of Biological Sciences (IBSc), University of Rajshahi for his constant supervision, active cooperation and constructive criticism in carrying out this work successfully.

I convey my sincere appreciation and indebtedness to my Co-supervisor, Dr. Dinesh Mondal, Senior Scientist, Parasitology Laboratory, International Centre for Diarrhoeal Disease Research (ICDDR,B), Dhaka, Bangladesh for his constant guidance, making necessary arrangements for performing molecular diagnostic tests, statistical analysis and for all out cooperation in connection with accomplishment of this work.

I gratefully acknowledge the cooperation of Dr. Rashidul Haque, Head of Parasitology Lab of ICDDR,B. It's my great pleasure to acknowledge Md. Gulam Musawwir Khan, former Research Investigator, Khondaker Rifat Hasan Bhaskar, former Research Officer, Md. Mamun Huda, Assistant Scientist and Md. Abdul Alim of Parasitology Laboratory, ICDDR,B for their whole hearted collaboration and cooperation in connection with the laboratory works and statistical analysis of data.

My sincere thanks go to Prof. Tanzima Yeasmin, honorable Director, Institute of Biological Sciences for her generous cooperation. I would like to extend my gratitude to Prof. Pervez Hassan and all other respected members of academic staff, office staffs and supporting staffs of IBSc for their kind cooperation.

I am grateful to Prof. ABM Abdul Hannan, former Principal of Rajshahi Medical College for his kind cooperation at the beginning of this research work. I would like to extend my sincere thanks and gratitude to Professor Dr. ARM Saifuddin Ekram, former Head, Department of Medicine, Dr. Md. Azizul Haque, Associate Professor of Medicine, Prof. Md. Iqbal Bari, Head, Department of Paediatrics, Dr. Md. Asgar Hossain, Associate Professor of

Paediatrics of Rajshahi Medical College for their kind referral of kala-azar patients and disease controls included in this study.

I gratefully acknowledge Prof. Iftikhar Ahmed, former Head, Department of Microbiology, Prof. Dr. Md. Abdullah Siddique, Head, Department of Microbiology, Dr. Khandker Md. Faisal Alam, Assistant Professor of Microbiology, Prof. Shah Md. Badruddoza, Head, Department of Pathology, Dr. Shahanara Begum, former Assistant Professor of Microbiology, Dr. Md. Obaidur Rahman Chowdhury, former Assistant Professor of Oral Surgery and Dr. SM Asafudullah, Associate Professor of Pathology of Rajshahi Medical College for their valuable suggestions and constant encouragement through out this research work.

My heartfelt thanks go to all doctors and staff nurses of different Medical and Paediatric units of Rajshahi Medical College Hospital for their wholehearted support in connection with sample collection. My special regards to all teaching staffs and the postgraduate students of the Department of Microbiology of Rajshahi Medical College for their moral support. I am much indebted to Mr. Golam Mostofa and Mr. Abu Sadat Md. Sayem, Medical Technologists (Lab), Department of Microbiology for their assistance in performing laboratory tests. I am grateful to all supporting staffs of the Department of Microbiology, Rajshahi Medical College.

I acknowledge with great empathy the enormous contributions provided by my respected brother-in-law, Dr. Md. Badrul Islam, Professor of Geology and Mining, University of Rajshahi. My passion and love go to my wife Dr. Irine Banu Lucy, Professor of Physics, University of Rajshahi, who is around me all the time sharing the pain and pleasure of this research work. I find no suitable words to compliment my loving children, Moushumi, Sakib and Sarah who have been constant source of inspiration for me. Finally, I express my regards to all study population.

CONTENTS

	Page No.
Acknowledgements	
Abbreviations	i
Abstract	vi
List of illustrations	x
Chapter 1 INTRODUCTION	1-16
1.1 Introduction	1
1.2 Kala-azar in Bangladesh: Historical perspective	10
1.3 Justification of the study	13
1.4 Aims and Objectives	16
1.4.1 General Objective	16
1.4.2 Specific Objectives	16
Chapter 2 REVIEW OF LITERATURE	17-57
2.1 Leishmaniasis: global magnitude	17
2.2 Prevalence of kala-azar in Bangladesh	18
2.3 Visceral leishmaniasis	22
2.3.1 Definition	22
2.3.2 Aetiology	23
2.3.3 Parasite morphology	24
2.3.4 Life cycle of <i>L. donovani</i>	25
2.4 Vector	26
2.5 Modes of transmission	26
2.6 Pathogenesis	27
2.7 Host parasite relationship	29
2.8 Clinical manifestations of kala-azar	32
2.9 Post kala-azar dermal leishmaniasis (PKDL)	32
2.10 Laboratory diagnosis of visceral leishmaniasis	33
2.10.1 Parasitological diagnosis	34
Microscopy	34
Culture	36
2.10.2 DNA-based molecular diagnosis	36
2.10.3 Loop-mediated isothermal amplification (LAMP)	38
2.10.4 Immunodiagnosis	39
Antigen detection	39
Antibody detection	39
2.11 HIV-leishmania coinfection	45
2.12 Genotyping of Leishmania	46
2.12.1 Background	46

2.12.2	Molecular epidemiology and molecular markers for Leishmaniasis	48
2.12.3	Molecular markers for Leishmania at species level	49
2.12.4	Molecular markers used for differentiating Leishmania at strain level	52
2.12.5	Targets for genotyping and DNA sequencing	53
	Internal transcribed spacer (ITS) sequence	53
	Mini-exon sequences	55
2.13	VL Elimination programme in Bangladesh	56
 Chapter 3 MATERIALS AND METHODS		 58-81
3.1	Ethical statement	58
3.2	Sample size and study population	58
3.2.1	Study Population	59
3.2.2	Eligibility criteria for suspected kala-azar case	60
3.2.3	Inclusion criteria and clinical evaluation of kala-azar patient	60
3.2.4	Exclusion criteria of kala-azar patient	61
3.3	Data management	61
3.4	Study type and place	61
3.5	Study period	62
3.6	Sample collection	62
3.7	Laboratory methods	62
3.7.1	Parasitological diagnosis	62
	Splenic aspiration	62
	Splenic smear microscopy	62
	Collection of blood	63
	Preparation and utilization of buffy coat	63
	Buffy coat smear microscopy	64
3.7.2	Serological diagnosis	64
	Utilization of Plasma	64
	Immunochromatographic test for kala-azar	65
	Procedural notes for rK39 ELISA	67
	Procedural notes for rK28 ELISA	68
3.7.3	Molecular diagnosis	69
	Buffy coat DNA extraction for PCR	69
	Leishmania nested PCR (Ln-PCR)	70
	Gel detection of Ln-PCR products	73
	Loop Mediated Isothermal Amplification (LAMP)	73
	Mini-exon PCR	76
	ITS1 and ITS2 PCR	77
3.8	Genotyping of Leishmania by ITS1-RFLP analysis	79
3.9	Genetic diversity analysis by DNA sequencing	80

3.9.1	Methodology	80
3.9.2	DNA sequencing data analysis	80
3.10	Statistical analysis	81
3.10.1	Factor analysis for evaluation of VL diagnostic tools	81
 Chapter 4 RESULTS		 82-129
4.1	Demographic and clinical characteristics of kala-azar patients	82
4.2	Demographic, clinical and laboratory findings of endemic and non-endemic controls	90
4.3	Demographic, clinical and laboratory findings of disease controls	92
4.4	Spleen smear microscopy	94
4.5	Results of serological tests	95
4.6	Results of Buffy coat smear microscopy	98
4.7	Results of different PCR methods	98
4.8	Results of Loop-mediated isothermal amplification (LAMP)	103
4.9	Diagnostic indices of different tools for kala-azar	105
4.10	Correlations	107
4.10.1	Spearman correlations of tools against spleen smear	107
4.10.2	Spearman correlations of different serodiagnostic tools	108
4.11	McNemar pair test of diagnostic tools against spleen smear	109
4.12	Comparison of performance of diagnostic tools in respect to spleen smear parasite load	111
4.13	ROC analysis of diagnostic tools for sensitivity and specificity	113
4.13.1	ROC comparison of molecular tools against gold standard (spleen smear)	113
4.13.2	ROC comparison of serological tools and buffy coat smear against gold standard (spleen smear)	116
4.14	Index analysis of diagnostic tools for evaluation of ranking	119
4.15	Proposed diagnostic algorithm for kala-azar in Bangladesh	122
4.16	Leishmania genotyping results	125
 Chapter 5 DISCUSSION		 130-149
5.1	Discussion	130
5.2	Conclusion	147
4.3	Recommendations	149
 REFERENCES		 150-183
 APPENDIX		 184-224

LIST OF ABBREVIATIONS

AIDS	: Acquired immunodeficiency syndrome
ALL	: Acute lymphoblastic leukaemia
AmBisome	: Amphotericin B liposomal
AML	: Acute myeloblastic leukaemia
AT	: Aldehyde test
AUC	: Area under curve
BC	: Buffy coat
BCC	: Behavior communication change
BMI	: Body mass index
BSA	: Bovine serum albumin
BT	: Bleeding time
CD	: Cluster of differentiation
CDC	: Centre for disease control/Communicable disease control
CFT	: Complement fixation test
CI	: Confidence interval
CL	: Cutaneous leishmaniasis
CLD	: Chronic liver disease
CML	: Chronic myeloblastic leukaemia
cpB	: Cysteine protease B
CSA	: Crude soluble antigen
CT	: Clotting time
DAT	: Direct agglutination test
DDT	: Dichloro diphenyl trichloroethane
DDW	: Deionized distilled water
°C	: Degree Celsius
DGHS	: Directorate General of Health Services
dL	: Deci liter
DNDi	: Drugs for neglected diseases initiative
DNA	: Deoxyribo nucleic acid
DPP	: Dual path platform

DTH	: Delayed type of hypersensitivity
EDTA	: Ethylene diamine tetra acetic acid
ELISA	: Enzyme linked immunosorbent assay
ESR	: Erythrocyte sedimentation rate
ETS	: External transcribed sequence
≥	: Equal or more than
FA	: Factor analysis
FAST	: Fast agglutination screening test
FDA	: Food and drug administration
F/H	: Family history
g	: Gram
GLP	: Good laboratory practice
gp63	: Glycoprotein 63
Hae III	: Haemophilus aegyptius restriction endonuclease III
HASPB1	: Histone 1 (H1) and hydrophilic acylated surface protein B1
Hb	: Haemoglobin
HIV	: Human immunodeficiency virus
HRM	: High-resolution melt
hsp70	: Heat shock protein 70
IAMEBBC	: Institutional Animal, Medical Ethics, Biosafety and Biosecurity Committee
ICT	: Immunochromatographic test
ICDDR,B	: International centre for diarrhoeal disease research, Bangladesh
ID	: Identification
IEDCR	: Institute of epidemiology, disease control & research
IFA	: Immunofluorescent antibody
IFAT	: Indirect fluorescent antibody test
IFN	: Interferon
IgG	: Immunoglobulin G
IgM	: Immunoglobulin M
IGS	: Intergenic spacer
IL	: Interleukin

IP	: Interferon-gamma inducible protein
IRS	: Indoor residual spraying
IS	: Index score
ITS	: Internal transcribed spacer
IU	: International unit
IVM	: Integrated vector management
JICA	: Japan International cooperation agency
KA	: Kala-azar
KAtex	: Kala-azar latex agglutination test
kDNA	: Kinetoplast deoxyribo nucleic acid
kb	: Kilobase pair
kDa	: Kilo dalton
L	: Liter
LAMP	: Loop mediated isothermal amplification
LD	: Leishman Donovan
<	: Less than
Ln-PCR	: Leishmania nested polymerase chain reaction
LPS	: Lipopolysaccharide
MCL	: Mucocutaneous leishmaniasis
medRNA	: Mini-exon derived RNA
MEGA	: Molecular evolutionary genetics analysis
MEP	: Malaria eradication programme
µg	: Microgram
MHC	: Major histocompatibility complex
min	: Minute
ml	: Milliliter
µL	: Microliter
MLEE	: Multilocus enzyme electrophoresis
MLST	: Multilocus sequence typing
MLMT	: Multilocus microsatellite typing
mm	: Millimeter
µm	: Micrometer

mRNA	: Messenger RNA
MS	: Microsoft
MSF	: Medecins Sans Frontieres
N	: Normal/Number
ng	: Nano gram
NK	: Natural killer cell
nm	: Nano meter
NRAMP	: Natural resistance associated macrophage protein
NTS	: Non-transcribed spacer
OD	: Optical density
P	: Probability
PBS	: Phosphate buffer solution
PCR	: Polymerase chain reaction
P/H	: Past history
PKDL	: Post kala-azar dermal leishmaniasis
pmol	: Pico mol
PT	: Prothrombin time
PTB	: Pulmonary tuberculosis
PUO	: Pyrexia of unknown origin
QT-NASBA	: Quantitative nucleic acid sequence-based amplification
Raj	: Rajshahi
RAPD	: Randomly amplified polymorphic DNA
RBC	: Red blood cell
rDNA	: Ribosomal DNA
RDT	: Rapid diagnostic test
RFLP	: Restriction fragment length polymorphism
rK9	: Recombinant kinesin-related protein 9
rK26	: Recombinant kinesin-related protein 26
rK28	: Recombinant kinesin-related protein 28
rK39	: Recombinant kinesin-related protein 39
rKRP42	: Recombinant kinesin-related protein 42
RLB	: Reverse line blot hybridization
RMC	: Rajshahi Medical College

RMCH	: Rajshahi Medical College Hospital
RNA	: Ribonucleic acid
ROC	: Receiver operator characteristic
rpm	: Revolution per minute
rRNA	: Ribosomal RNA
SAG	: Sodium antimony gluconate
SD	: Standard deviation
SDS-PAGE	: Sodium dodecyl sulfate polyacrylamide gel electrophoresis
SE	: Standard error
sec	: Second
SL	: Spliced leader
SPSS	: Statistical package for social science
SSU rDNA	: Small subunit ribosomal DNA
SSU rRNA	: Small subunit ribosomal RNA
TCA	: Tri cyclic acid
TDR	: Tropical disease research
Th	: T-helper lymphocyte
THC	: Thana Health Complex
Tk.	: Taka
TMB	: Tetramethyl benzidine
TNF	: Tumour necrosis factor
UV	: Ultraviolet
VL	: Visceral leishmaniasis
WBC	: White blood cell
WHO	: World Health Organization

ABSTRACT

Visceral leishmaniasis (VL) or kala-azar is a neglected chronic systemic illness caused by *Leishmania donovani*. Clinical diagnosis of VL is inaccurate even in patients meeting the clinical case definition, so laboratory confirmation is essential. Current diagnostic tests include parasitological, immunological and PCR-based molecular methods. Except serology all other methods are not suitable as point-of-care test in remote endemic areas. Serological test by rK39 antigen is being used in the Indian subcontinent with very high sensitivity but it lacks discriminatory power between active VL and past or asymptomatic cases. So, always there is search for new diagnostic innovation which will be highly accurate, cheap, simple and rapid for successful VL management and to achieve the goal of current elimination programme. The present study was designed to formulate an applicable diagnostic algorithm based on comparative evaluation of available VL diagnostic tests aiming to facilitate more case detection from different levels of health care facilities in our country. The work also focused on exploration of genotype and genetic diversity of *Leishmania* strain for its taxonomical status.

Study population comprised of 200 subjects including 100 confirmed VL patients (spleen smear positive for LD body) admitted in the Rajshahi Medical College Hospital (RMCH), Bangladesh and 100 controls (30 endemic, 30 non-endemic and 40 disease controls) from July, 2010 to January, 2013. Parasitological (spleen and buffy coat smear microscopy), serological (RDT and ELISA against both rK39 & rK28) and molecular diagnostic tests like Loop-mediated isothermal amplification (LAMP) and different PCR (Ln-PCR, Mini-exon, ITS1 and ITS2) methods were carried. Buffy coat was separated by concentration gradient separation technique to be utilized for smear preparation and DNA extraction. Parasite load in spleen smear was graded from 1+ to 6+ and performances of tools other than serology were compared with parasitic load. Diagnostic sensitivity, specificity and accuracy were calculated using online clinical calculator. Performances of different diagnostic tools against

gold standard (spleen smear) were compared by McNemar's test and correlations between tools were done by Spearman correlation. The kappa value of different tools against spleen smear was used to construct a receiver-operator characteristic (ROC) curve. Diagnostic tools were ranked (1 to 10) based on kappa value, cost, interpretation, availability, user friendliness, test type and potential for field use. Diagnostic algorithm for VL in Bangladesh was formulated based on the diagnostic indices and index scoring of tools. Genotyping by ITS1-RFLP and DNA sequence analysis of ITS1 and ITS2 PCR products was done for polymorphism. Phylogenetic tree was constructed using maximum parsimony by the MEGA (Molecular Evolutionary Genetics Analysis) computer program, Version 5.05 and compared with reference strains.

Parasitic load was demonstrated as grade 1+ (8%), 2+ (41%), 3+ (34%), 4+ (10%), 5+ (6%) and 6+ (1%). Diagnostic sensitivity, specificity and accuracy at 95% CI respectively of rK39 ICT (99%, 96%, 95%), rK39 ELISA (98%, 97%, 95%), rK28 ICT (99%, 90%, 89%), rK28 ELISA (98%, 94%, 92%), Buffy coat smear (93%, 100%, 93%), Ln-PCR (94%, 99%, 93%), LAMP (89%, 100%, 89%), Mini-exon PCR (86%, 100%, 86%), ITS1 PCR (85%, 100%, 85%) and ITS2 PCR (80%, 100%, 80%) were noted. All diagnostic tools correlated significantly ($P=0.0001$) with gold standard. Correlation between rK39 and rK28 ICT was 0.942 ($P=0.0001$) and between rK39 and rK28 ELISA was 0.930 ($P=0.0001$). Pair-wise comparison of Buffy coat smear, Ln-PCR, LAMP, Mini-exon, ITS1 and ITS2 PCR against gold standard was found significant ($P<0.05$). Different PCR methods were also found significantly ($P<0.05$) comparable to Ln-PCR. Buffy coat smears was found 100% positive among grades $\geq 3+$ parasite load cases but other tools did not show significant correlation with parasite load. ROC analysis in respect to gold standard revealed AUC (at 95% CI) of 0.965 (SE=0.0129), 0.945 (SE=0.0157), 0.930 (SE=0.0174), 0.925 (SE=0.0179) and 0.900 (SE=0.0201) respectively for Ln-PCR, LAMP, Mini-exon, ITS1 and ITS2 PCR. While, AUC (at 95% CI) of rK39 ICT, rK39 ELISA, rK28 ICT, rK28 ELISA and buffy coat smear was 0.975 (SE=0.0110), 0.975 (SE=0.0111), 0.945 (SE=0.0159), 0.960

(SE=0.0139), and 0.965 (SE=0.0128) respectively. Index score (IS) of diagnostic tools showed rK39 ICT as the best diagnostic option (Rank=1, IS=1.65335) followed by rK28 ICT (Rank=2, IS=1.48776), Buffy coat smear (Rank=3, IS=0.50764), rK39 ELISA (Rank=4, IS=0.2963), rK28 ELISA (Rank=5, IS=0.2963), Ln-PCR (Rank=6, IS= -0.7158), LAMP (Rank=7, IS= -0.88139), Mini-exon PCR (Rank=8, IS= -0.88139) ITS1 PCR (Rank=9, IS= -0.88139), and ITS2 PCR (Rank=10, IS= -0.88139) for kala-azar. In the diagnostic algorithm, RDT (rK39 or rK28) was proposed as the most preferred test. Genotyping revealed *L. donovani* as the sole agent for kala-azar and DNA sequencing explored no polymorphism. All 14 Bangladeshi strains including 4 from present study (Raj 21, Raj 64, Raj 68 and Raj 85) were found exactly identical to strain ID, DON 39, with Zymodeme MON-2, isolated from Indian VL patient (gene accession No. AJ634376). Kala-azar patients' characteristics showed male to female ratio of 2.13:1 with mean age, monthly income and duration of fever as 20.66±15.863 years, Tk. 4005±2631.871 and 20.61±12.518 weeks respectively. Patients had splenomegaly (98%), hepatomegaly (76%), anaemia (99%), wasting (100%), blackening (96%), weight loss (100%), family history of VL (18%), past history of VL (13%), jaundice (2%), bleeding (9%) and pancytopenia (40%) as presenting features.

All diagnostic tests showed good to excellent sensitivity (80% to 99%) and specificity (90% to 100%). rK39 ICT ranked #1 and was proposed as the most preferred diagnostic test in the diagnostic algorithm. Buffy coat smear may be suitable alternative to conventional invasive procedures and is preferred parasitological confirmation for asymptomatic, treatment failure, relapse or immunodeficient VL patients. Ln-PCR or LAMP can be good adjunct for confirmation of kala-azar. Genotyping revealed *L. donovani* as the agent of kala-azar in Bangladesh, identical to Indian strain (DON 39, Zymodeme MON-2) and there is no strain polymorphism.

LIST OF ILLUSTRATIONS
Tables

Table No.	Title	Page No.
Table 3.1	First set of primers for Ln-PCR	71
Table 3.2	PCR master mix for first amplification in Ln-PCR	71
Table 3.3	Protocol for first amplification in Ln-PCR	71
Table 3.4	Second set of primers for Ln-PCR	72
Table 3.5	PCR master mix for second amplification in Ln-PCR	72
Table 3.6	Protocol for second amplification in Ln-PCR	72
Table 3.7	Primers for LAMP	75
Table 3.8	PCR master mix for LAMP	76
Table 3.9	Primers for Mini-exon PCR	76
Table 3.10	PCR master mix for Mini-exon PCR	77
Table 3.11	Protocol for Mini-exon PCR	77
Table 3.12	Primers for ITS1 PCR	78
Table 3.13	Primers for ITS2 PCR	78
Table 3.14	PCR master mix for ITS1 and ITS2 PCR	78
Table 3.15	Protocol for ITS1 and ITS2 PCR	79
Table 4.1	Demographic and clinical characteristics of kala-azar patients	84
Table 4.2	Demographic, clinical and laboratory findings of endemic and non-endemic controls	91
Table 4.3	Demographic, clinical and laboratory findings of disease controls	93
Table 4.4	Diagnostic indices of different tools for kala-azar	105
Table No.	Title	Page No.
Table 4.5	Spearman correlations (Spleen smear vs. others)	107

Table 4.6	Correlation of performance between RDTs (rK28 vs. rK39)	108
Table 4.7	Correlation of performance between ELISA (rK28 vs. rK39)	108
Table 4.8	McNemar pair test results (Spleen smear vs. others)	109
Table 4.9	McNemar pair test between Ln-PCR and Mini-exon PCR	110
Table 4.10	McNemar pair test between Ln-PCR and ITS1 PCR	110
Table 4.11	McNemar pair test between Ln-PCR and ITS2 PCR	111
Table 4.12	Diagnostic performances of different tools in respect to different grades of parasite load in spleen smear	112
Table 4.13	AUC of different molecular tools in ROC	113
Table 4.14a	Pair-wise comparison of Ln-PCR vs. others	114
Table 4.14b	Pair-wise comparison of LAMP vs. others, Mini-exon vs. others and ITS1 vs. ITS2	115
Table 4.15	AUC of different serological tools and buffy coat smear in ROC	117
Table 4.16a	Pair-wise comparison of rK39 ICT vs. others	117
Table 4.16b	Pair-wise comparison between serological tools and buffy coat	118
Table 4.17	Scoring of diagnostic tools based on different indicators	120
Table 4.18	Ranking of diagnostic tools for kala-azar based on index scoring calculated from inherent features	121
Table 4.19	Phylogenetic status of strains detected in this study and comparison with reference strains	128
Table 4.20	Microsatellite repeat numbers of strains of the <i>L. donovani</i> detected in this study and comparison with other strains from Bangladesh	129

Figures

Figure No.	Captions	Page No.
Fig. 2.1	Prevalence of kala-azar cases in Bangladesh	20
Fig. 2.2	Kala-azar cases and deaths from 1999 to October 2012 in Bangladesh	21
Fig. 2.3	District-wise frequency of kala-azar cases in Bangladesh	21
Fig. 2.4	Life cycle of <i>L. donovani</i>	25
Fig. 2.5	Sandfly (<i>Phlebotomus argentipes</i>)	26
Fig. 2.6	Representation of the rDNA gene complex indicating gene order and position of the ITS regions	54
Fig. 2.7	The Mini-exon repeat of <i>Leishmania</i>	55
Fig. 3.1	Primers and their locations for amplification of <i>L. donovani</i> kinetoplast minicircle DNA by LAMP	75
Fig. 4.1	Gender distribution of study population (kala-azar patients and controls)	85
Fig. 4.2	Age distribution of kala-azar patients	85
Fig. 4.3	Monthly income (Tk.) of kala-azar patients	86
Fig. 4.4	Duration of fever (in weeks) among kala-azar patients	86
Fig. 4.5	Grades of anaemia among kala-azar patients	87
Fig. 4.6	Geographical distribution of kala-azar patients	88
Fig. 4.7	District-wise number and gender distribution of kala-azar patients	89
Fig. 4.8	Distribution of ESR among kala-azar patients	89
Fig. 4.9	Spectrum of diseases and their number among disease controls	94
Fig. 4.10	Distribution of grades of parasite load in spleen smears among kala-azar patients	95
Fig. 4.11	Results of rK39 ICT among study population	95
Fig. 4.12	Results of rK39 ELISA among study population	96

Figure No.	Captions	Page No.
-------------------	-----------------	-----------------

Fig. 4.13	Results of rK28 ICT among study population	97
Fig. 4.14	Results of rK28 ELISA among study population	97
Fig. 4.15	Buffy coat smear microscopy showing amastigote form of LD body	98
Fig. 4.16	Results of different PCR methods among kala-azar patients	99
Fig. 4.17	Gel electrophoresis pattern of Ln-PCR amplified products	100
Fig. 4.18	Gel electrophoresis pattern of Mini-exon amplified products	101
Fig. 4.19	Gel electrophoresis pattern of ITS1 PCR amplified products	102
Fig. 4.20	Gel electrophoresis pattern of ITS2 PCR amplified products	103
Fig. 4.21A	Naked eye visualization of LAMP products	104
Fig. 4.21B	Gel electrophoresis pattern of LAMP amplified products	104
Fig. 4.22	Sensitivity of different diagnostic tools for kala-azar	106
Fig. 4.23	Specificity of different diagnostic tools for kala-azar	106
Fig. 4.24	ROC curves showing comparison of molecular diagnostic tools with gold standard (spleen smear)	116
Fig. 4.25	ROC curves showing comparison of serological tools and buffy coat smear with gold standard (spleen smear)	119
Fig. 4.26	ITS1-RFLP genotyping	126
Fig. 4.27	Phylogenetic relationship among strains of the <i>L. donovani</i>	127

Appendix

Appendix No.	Title	Page No.
Appendix-7	Grading of amastigotes in splenic smear	194
Appendix-9	Buffy coat preparation	197
Appendix-10	rK39 Immunochromatographic test	198
Appendix-11	rK28 Immunochromatographic test	199
Appendix-12	Microscopic view of LD bodies in spleen smear	200
Appendix-17a	Master Chart (kala-azar patient's demographic and clinical characteristics)	209
Appendix-17b	Master Chart (kala-azar patient's laboratory test results)	213
Appendix-18a	Master Chart (endemic control's demographic and clinical characteristics)	217
Appendix-18b	Master Chart (endemic control's laboratory test results)	218
Appendix-19a	Master Chart (non-endemic control's demographic and clinical characteristics)	219
Appendix-19b	Master Chart (non-endemic control's laboratory test results)	220
Appendix-20a	Master Chart (disease control's demographic and clinical characteristics)	221
Appendix-20b	Master Chart (disease control's laboratory test results)	223

Chapter 1

INTRODUCTION

1.1 Introduction

Visceral leishmaniasis (VL) or kala-azar is a vector borne parasitic disease caused by an obligate intracellular haemoflagellate called *Leishmania donovani* (Leishman, 1903). It is considered to be an emerging and reemerging zoonosis of considerable health problem worldwide. Natural transmission of *Leishmania* is exclusively carried out by the bite of a tiny 2 to 3 mm long female sandfly of the genus *Phlebotomus* (Old World) or *Lutzomyia* (New World). An infected human acts as reservoir in the Indian subcontinent (Sharma *et al.*, 2000).

Kala-azar (KA) is a systemic disease characterized by prolonged undulating fever, splenomegaly, hepatomegaly, substantial weight loss, progressive anaemia, pancytopenia, bleeding manifestation, hypergammaglobulinemia and is complicated by serious intercurrent infections if left untreated (Sarker *et al.*, 2003a; Jeronimo *et al.*, 2006). VL is a neglected, life-threatening tropical disease affecting the poorest of the poor, as this vector-borne disease is strongly linked to poor housing (Boelaert *et al.*, 2009). It causes significant morbidity and mortality of socially marginalized population in South Asia (Ahluwalia *et al.*, 2003). The appearance of clinical features depends on the complex interactions resulting from the invasiveness, tropism and pathogenicity of the parasite and the immune response of the host (Campos-Ponce *et al.*, 2005). The reemergence and spread of this disease worldwide have been attributed to 3 main risk factors: (i) environmental changes of human origin, (ii) immunosuppression, and (iii) treatment failure and drug resistance (Dujardin, 2006).

The epidemiology of leishmaniasis is extremely diverse and far from fully elucidated (Guizani, 2004). In terms of global burden of disease, the leishmaniasis are the third most important vector-borne disease. There are more than 20 species of *Leishmania* parasites known to infect humans with approximately 30 species of sandfly to transmit the disease (Killick-Kendrick, 1990). The VL has recently been shown to be far more prevalent and of greater public health importance than was previously recognized. The disease is geographically widespread threaten 350 million people worldwide with an estimated annual incidence of 0.2-0.4 millions and 10% fatality rate, a death toll that is surpassed among the parasitic diseases only by malaria (Alvar *et al.*, 2012). Surprisingly, more than 90% of world's VL burden occurs in Bangladesh, India, Nepal, Sudan, Ethiopia and Brazil. More surprisingly, India, Bangladesh and Nepal, the three bordering countries together account for about 67% of all reported VL cases in the world with about 200 million people are estimated to be at risk of developing VL (Chappuis *et al.*, 2007). A recent report estimated the VL burden in Bangladesh is about 12,400-24,900 new cases annually with a mortality rate of 1.5% (Alvar *et al.*, 2012). The governments of these countries committed to launch a regional VL elimination program in 2005 by using a local approach to reduce the annual incidence of VL to less than 1 case per 10,000 individuals by 2015.

In Bangladesh, resurgence of the disease occurred during late seventies following cessation of insecticide spraying for malaria control programme (Nasiruddin, 1952; Rahman and Islam, 1983). During last three decades, increasing number of kala-azar cases has been reported from various parts of Bangladesh (El-Masum *et al.*, 1995; Chowdhury *et al.*, 1993a). At present, kala-azar is a reemerging major public health problem in our country. The current prevalence is estimated to be 45,000 cases with more than 40.6 million populations are at risk of developing the disease. Out of 64 districts, at least 45 districts have been reportedly affected by kala-azar (Rahman *et al.*, 2008). Available reports show that many parts of Bangladesh are at present at least hyperendemic for the disease.

Visceral leishmaniasis is typically caused by the *Leishmania donovani* complex, which includes three species: *L. donovani*, *L. infantum* and *L. chagasi*. The disease is almost exclusively caused by *L. donovani* in the Indian subcontinent (Sundar *et al.*, 2001; Alam *et al.*, 2009b). Post kala-azar dermal leishmaniasis (PKDL) is a sequel of treated or spontaneously cured kala-azar appears in a few cases within 2 years in Indian subcontinent (Chowdhury *et al.*, 1991; Zijlstra *et al.*, 2003). PKDL cases are considered as putative reservoir hosts in the transmission of infection in the community (Thakur and Kumar, 1992). Leishmaniasis is anthroponotic in origin in the Indian subcontinent and *Leishmania* parasites have a digenic life cycle that alternate the intracellular parasitism of mammalian macrophages by non-motile amastigotes, with the infection of the vector digestive tract by the extracellular flagellated promastigotes (Bogdan and Rollinghoff, 1999).

The diagnosis of VL is not straightforward all the time, because its clinical features are shared by a host of other diseases such as malaria, typhoid fever, relapsing fever, liver abscess, leukaemia and trypanosomiasis. Moreover, sequestration of the parasites in the organs of reticuloendothelial system like spleen, bone marrow or lymph nodes further complicates the issue of diagnosis. Although diagnosis of leishmaniasis can be made on the basis of clinical and epidemiological data but it has to be confirmed by the demonstration of the parasite to avoid potential misdiagnosis (Pearson *et al.*, 2001). At present, the classical methods of direct detection of the parasite include visualization of amastigotes by microscopic examination of stained smears and in vitro culture of the parasite. Though microscopic examination is rapid, cheap, and easy to perform, it lacks sensitivity due to the generally low number of parasites in tissue samples. Culture techniques are more sensitive but require a sophisticated laboratory setup, are time-consuming and harbour the risk of contamination. Thus culture of *Leishmania* is not a routine clinical practice rather it is confined to research laboratories (Sundar and Rai, 2002a). For classical parasitological diagnosis to be made, splenic or bone-marrow aspirations are usually practiced but the procedures are technically very

demanding and patient needs hospitalization. Spleen aspiration can be complicated by life threatening haemorrhage in about 0.1% of individuals and therefore requires strict precautions, training and technical expertise, as well as facilities for nursing surveillance, blood transfusion and surgery. The sensitivity of bone marrow smear is low and it is a painful and cumbersome procedure too. Often these modalities are not available in disease-endemic areas. Although the specificity is high, the sensitivity of microscopy varies; being higher for spleen (93–99%) than for bone marrow (53–86%) or lymph node (53–65%) aspirates (Kager and Rees, 1983; Zijlstra *et al.*, 1992; Sarker *et al.*, 2004; Babiker *et al.*, 2007). On the contrary, peripheral blood buffy coat which contains monocytes concentrates harboring the parasites could be an attractive and alternative specimen for detection of LD bodies. In a few studies its sensitivity ranged from 50 to 99% (Monica, 1998; Shamsuzzaman *et al.*, 2007; Salam *et al.*, 2012). For buffy coat it requires minimally invasive procedure like venipuncture to collect only 3-5 mL of blood and it does not involve any risk other than usual risk for venipuncture. Parasitological diagnosis by buffy coat smear is a rapid, cost-effective and risk-free method with the potential to be used as a point-of-care test.

Considering the limitations of parasitological diagnosis, several serological tests have been developed for VL. Aldehyde and Chopra antimony tests detect high levels of nonspecific immunoglobulins and the results can be positive in host conditions (Bray, 1985). Lack of specificity as well as varying sensitivities, render these tests highly unreliable. Conventional methods for anti-leishmania antibody detection include gel diffusion, complement fixation test (CFT), indirect haemagglutination test, indirect fluorescent antibody test (IFAT) and countercurrent immunoelectrophoresis (Hockmeyer *et al.*, 1984; Sinha and Sehgal, 1994). However, aside from practical difficulties at peripheral laboratories, widely varying sensitivities and specificities of most of the above mentioned serological tests have been the limiting factors. Except for the IFAT, which is used on a limited scale, these tests are rarely used at present for routine diagnosis of VL. Direct agglutination test (DAT), which is based on

agglutination of formalin fixed whole parasites by anti-leishmanial antibodies, is a relatively simple test and has been used in Sudan regularly (Harith *et al.*, 1988; Boelaert *et al.*, 1999). But batch to batch variations, requirement of refrigerator, long incubation and multiple pipetting steps are major handicaps and thus DAT has not been popular as a routine diagnostic test in the Indian subcontinent (Chappuis *et al.*, 2006). Enzyme linked immunosorbent assay (ELISA) has been used as a potential serodiagnostic tool for almost all infectious diseases including leishmaniasis (Kumar *et al.*, 2001). The technique is highly sensitive but its specificity depends upon the antigen used. A recombinant kinesin-related protein antigen (rK39) has been shown to be specific for antibodies in patients with VL caused by members of *L. donovani* complex (Bern *et al.*, 2000). This antigen has been reported to be nearly 100% sensitive and 100% specific in the diagnosis of Indian kala-azar and PKDL by ELISA (Kumar *et al.*, 2001; Sundar *et al.*, 2007; Salam *et al.*, 2009). However, these require expensive equipment, continuous power supply and skilled manpower, and thus are seldom used in endemic regions.

A promising ready-to-use rapid diagnostic test (RDT) that follows immunochromatographic assay (ICT) principle using rK39 antigen has been available commercially for use in field conditions (InBios, International Inc. Seattle, WA) for more than a decade. The test is simple, rapid (10 minutes), relatively inexpensive, require no other reagents or instruments and can be performed in the field by the paramedics. It has sensitivity around 100% and specificity of 93-98% reported by some investigators (Sundar *et al.*, 1998 and 2002b; Sarker *et al.*, 2003b; Salam, 2008) and is being used as recommended diagnostic test for kala-azar in the elimination program of Bangladesh, India and Nepal (Rahman *et al.*, 2008). Although ICT is an excellent test for making a diagnosis of kala-azar in otherwise immunocompetent patients where anti-leishmania antibodies are present in normal level but it becomes false negative in most of the HIV co-infected kala-azar patients and other immunosuppressive conditions (Mary *et al.*, 1992), which limits its use in certain endemic regions. Further, it can not discriminate between asymptomatic and active VL patients

and also it can not predict response to therapy or relapse, as IgG antibodies persist in blood for long time after successful treatment of infection (Sundar *et al.*, 2006). Thus, antibody based test results must always be interpreted in combination with a standardized clinical case definition for VL.

The development of Polymerase Chain Reaction (PCR) has provided a powerful approach to the application of molecular biology techniques to the diagnosis of leishmaniasis. Primers designed to amplify conserved sequences found in minicircles of kinetoplast DNA (kDNA) of different *Leishmania* species were tested in various tissues of relevance. A wide range of sensitivities and specificities have been reported with PCR-based diagnostic methods for VL (Andresen *et al.*, 1997; Adhya *et al.*, 2002; Deborggraeve *et al.*, 2008a; Alam *et al.*, 2009c). PCR was found to be more sensitive than microscopy for detection of *Leishmania* parasites in lymph node and bone marrow aspirations as reported by a few investigators (Osman *et al.*, 1997; Reithinger and Dujardin, 2007). However, PCR assay with buffy coat as sample to detect *Leishmania* was 10 times more sensitive than that with whole-blood preparation (Lachaud *et al.*, 2001; Salam *et al.*, 2010). For PCR it requires a well-established laboratory set up and equipments such as a thermal cycler and a system to detect and analyze amplified products. Thus this facility is not widely available in resource-limited endemic areas of VL. Recently, a urine-based PCR assay had been validated for diagnosis and monitoring treatment efficacy of human visceral leishmaniasis (VL), taking advantage of the accessibility of urine as an absolutely non-invasive sample (Fisa *et al.*, 2008). More recently, loop-mediated isothermal amplification (LAMP) was developed as a novel method to amplify DNA extracted from whole blood or urine with rapidity and high specificity under an isothermal condition (Notomi *et al.*, 2000; Nagamine *et al.*, 2002), which has the future potential for field use. Although there is cafeteria choice of diagnostic laboratory tests for VL but in the question of availability and standardization of sensitivity and specificity still there is discrepancy among available tests. Highly accurate (both sensitive and specific), cheap, simple and rapid diagnostic tests (RDTs) are crucial not

only for successful management of VL patients but also to achieve the goal of current elimination programme. Early case detection followed by adequate treatment is also central to control VL because, as yet, no vaccine is available and the long-term impact of vector control is unclear (Boelaert *et al.*, 2007). Thus formulation of an appropriate diagnostic algorithm based on the comparative diagnostic indices of available tests is required to recommend test(s) applicable for different health care facilities especially in the endemic areas.

Apart from disease diagnosis, discrimination of species for *Leishmania* is important not only for epidemiological reasons but also for clinical evaluation. Identification of the parasite, exploration of its genotype and analysis of genetic diversity among the species are important for diagnosis as well as for epidemiological, taxonomic and population genetics investigations. Several molecular markers resolving genetic differences between *Leishmania* parasites at species and strain levels have been developed to address key epidemiological and population genetic questions. Because of differences among the *Leishmania* species in levels of virulence and in responses to the various chemotherapeutic regimens, correct identification is essential for diagnosis as well as to prospect clinical prognosis and chemotherapy (Romero *et al.*, 2001; Blum *et al.*, 2004). Since *Leishmania* species can not be distinguished morphologically (Schönian *et al.*, 2003), a variety of biochemical, immunological, and molecular tools have been developed for the differentiation of the pathogenic species, such as isoenzyme, serodeme, schizodeme analysis and hybridization techniques with species-specific DNA probes (Marfurt *et al.*, 2003).

To date, the gold standard for species and strain identification has been multilocus enzyme electrophoresis (MLEE). It has also been used to infer phylogenetic relationships within the genus (Pratlong *et al.*, 2001; Schönian *et al.*, 2008). However, isoenzyme analysis is slow, laborious, expensive and requires in-vitro cultivation. Moreover, it lacks discriminatory power (Kuhls *et al.*, 2005; Bañuls *et al.*, 2007). With the advances in molecular techniques, a number of molecular markers and PCR protocols for the detection of

Leishmania on different taxonomical levels (genus, complex, and species) have been reported (Schönian *et al.*, 2011; Boite *et al.*, 2012). Target sequences for characterization include either nuclear DNA, such as the small subunit rRNA (SSU rRNA) gene (Schönian *et al.*, 2011), a repetitive genomic sequence, the miniexon (spliced leader) gene repeat (Marfurt *et al.*, 2003), the gp63 gene locus (Boite *et al.*, 2012), internal transcribed spacer (ITS) regions (Dabirzadeh *et al.*, 2012); microsatellite DNA (Kuhls *et al.*, 2007; Alam *et al.*, 2009b) or kinetoplast DNA, such as minicircle sequences. Alternative genotyping techniques include DNA-based methods, such as restriction fragment length polymorphism analysis (RFLP) of kinetoplast and nuclear DNA (Srivastava *et al.*, 2011). While all the above mentioned approaches provide a multitude of valid taxonomic characters for differentiation, they are accompanied by a number of factors which limit their use in a routine diagnostic laboratory. In this context, an attractive genotyping method has been developed for the identification and differentiation of *Leishmania* species in clinical samples by PCR amplification of the miniexon or ITS sequence and subsequent restriction fragment length polymorphism analysis (Marfurt *et al.*, 2003).

To understand the phylogenetic relationships of species and strains within the *L. donovani* complex, ribosomal DNA (rDNA) internal transcribed spacers (ITS1 and ITS2) have been used as a reliable marker by many investigators (El-Tai *et al.*, 2000 & 2001). Sequence analysis of internal transcribed spacer (ITS1/ITS2) has been applied to infer phylogenetic relationships between different groups of strains of different geographical origins (Kuhls *et al.*, 2005).

Early correct diagnosis of kala-azar is important as the classical treatment is of long duration and can be complicated with many side effects. The availability of accurate laboratory tests is therefore, essential. Although the choice of diagnostic tests depends upon many factors and varies greatly in different levels of health care facilities but for any particular test to be introduced, it must be acceptable in terms of its sensitivity, specificity and reproducibility. There have been scanty reports on available diagnostic tools for kala-azar in

our country and still there is no consensus of appropriate diagnostic methods suitable for different levels of our health care facilities based on native research recommendation. Although rK39 rapid test is being used as case detection method for kala-azar elimination programme but considering its limitations in terms of specificity sufficient data have yet to be explored in our context. So, the present study was designed to make a comparative evaluation of parasitological (buffy coat smear microscopy), PCR-based molecular and serodiagnostic tests by exploring their sensitivity, specificity and accuracy in respect to spleen smear positive kala-azar patient, which is currently the gold standard for confirmatory diagnosis. The study was aimed to develop a diagnostic algorithm and to recommend appropriate test(s) for different health care facilities in Bangladesh. It particularly emphasized on elucidation of diagnostic performance of minimally invasive tests like the buffy coat smear for LD bodies, RDTs, LAMP and different PCR-based methods.

Further, as far as the genotype of *Leishmania* circulating in Bangladesh is concerned, there is very limited information available. Still there has been no work conducted in the endemic areas of greater Rajshahi, where there are significant number of kala-azar and PKDL cases are found round the year. The present study was also designed to determine the genotype of *Leishmania* by ITS1 PCR-RFLP (restriction fragment length polymorphism) analysis and exploration of genetic diversity through DNA sequencing of ITS1 and ITS2 amplicons. The phylogenetic status of the *Leishmania* was compared with available Bangladeshi and other reference strains for its taxonomical status.

1.2 Kala-azar in Bangladesh: Historical perspective

At the turn of the nineteenth century, Cunningham, Borovsky, Leishman, Donovan, Wright, Lindenberg and Vianna each independently identified the parasite that causes leishmaniasis, to which Ronald Ross gave the generic name *Leishmania* (Ross, 1903).

There are various terms used to describe the disease called visceral Leishmaniasis. The most commonly used term “kala-azar” was derived from two words, *Kala* (black) and *Azar* (sickness) which in Hindi means “black sickness” or black fever. The terms originally referred to Indian VL due to its characteristic symptoms, blackening or darkening of the skin of hands, feet and the abdomen (Lainson and Shaw, 1987). The word *Kala* in Hindi also means “deadly”, signifies the kala-azar as a fatal illness (Chatterjee, 1980). Kala-azar is called by many different names in different parts of the Indian subcontinent such as *Sikari disease*, *Burdwan fever*, *Sandfly fever*, *Dum Dum fever* (after the name of a district in Kolkata, where *L. donovani* was first found in an autopsy patient), *Shahib’s disease* and *Tropical splenomegaly* (Bahr and Bell, 1987). The disease called leishmaniasis is actually named for the Scottish Pathologist *William Boog Leishman*.

Historically kala-azar has been prevailing in Bangladesh for centuries. Available records indicate that it probably existed in this country in endemic form as early as fifth decade of the nineteenth century in the southern districts (Ghose and Bhattacharya, 1972). The disease was recognized in 1869 by the British troops engaged in war in the Garo district of the Indian Province of Assam (Rogers, 1944). A review of literature reveals that since the time of its recognition the disease had been endemic in Bangladesh with epidemic outbreaks of 10 years duration occurring every 15 to 20 years (Manson-Bahr and Bell, 1987). Kala-azar was noted in an explosive epidemic in India, in the Garo Hill areas and adjacent Bhramaputra valley of Assam on 1880. First accurate description of the disease was given by Clark, who in the Assam sanitary commission report for the year 1882 described the disease as malarial cachexia. From the history, it appears that the name kala-azar was present as early as 1869. Kala-azar prevailed in epidemic form in the then Bengal which comprised of the present Bangladesh and the Indian Province of West Bengal at the time of the discovery of its aetiological agent at the turn of the century in 1900.

Kala-azar was first described in 1824, in Jessore district, Bengal in what is now Bangladesh (Sanyal, 1985). Historical records describe the classical picture of kala-azar with prolonged irregular fever, progressive emaciation and enlargement of the spleen and liver. The disease spread west to other parts of Bengal (1830s-1850s), Dhaka district (1862), Rangpur in northern Bengal (1872), northeast into the Garo Hills of Assam (1872), and west into Bihar (1872) (Sengupta, 1947b). Kala-azar appeared to have spread along the courses of the Ganges and Brahmaputra rivers, the major transport routes (Sanyal, 1985). In these early outbreaks, the case-fatality rate was reported to be more than 95%, with community-wide mortality rates of above 25%. The epidemic that occurred in Jessore from 1824 to 1827 reportedly killed 75,000 people.

At the turn of the 20th century, kala-azar occurred as far south as Tamil Nadu, where Charles Donovan was a British military medical officer. Early in 1903, Donovan in Madras and Leishman in London independently demonstrated the causative parasite in splenic tissue in autopsies from kala-azar patients infected in India (Leishman, 1903; Donovan, 1903). Donovan performed a splenic aspirate in a young Indian patient in Madras later in 1903, demonstrating the parasite for the first time in a living patient. Within a few months, Ronald Ross proposed the name *Leishmania donovani* for the newly discovered parasite (Ross, 1903), although other classifications were used as late as the 1920s. Vector borne transmission was hypothesized from early in the 20th century. Experimental transmission of *L. donovani* by phlebotomine sandflies to animals was demonstrated in 1931 (Shortt *et al.*, 1931). In 1942, Swaminath *et al.* demonstrated *L. donovani* transmission by *Phlebotomus argentipes* to human volunteers, establishing this species of sandfly as the vector in South Asia (Swaminath *et al.*, 1942). The first 40 years of the 20th century also saw a series of key discoveries in the diagnosis, treatment and control of visceral leishmaniasis (Sengupta, 1947b). The aldehyde test was developed in 1921 and a complement fixation test in 1939. Splenic puncture was used from the early decades of the 20th century. Antimonial drugs were first introduced for South American mucocutaneous leishmaniasis in 1913 and for kala-azar in 1915. Early

trivalent antimonials caused severe toxicity, but the introduction of several pentavalent antimonials between 1915 and 1939 resulted in a 95% cure rate and treatment regimens do not vary much from those used today in Bangladesh. DDT and pyrethrum were known to be effective for sandfly control by the 1940s. Indeed, all of the major components of a kala-azar control programme were available by the 1940s (Sengupta, 1947b).

Kala-azar epidemic peaks were recorded in Bengal in the 1820s, 1860s, 1920s, and 1940s (Sanyal, 1985; Birley, 1993). In the 1920s, the All-Bengal Kala-azar Conference listed the districts most affected by kala-azar based on dispensary records as Tangail (in 1919), Rajshahi, Jessore, Mymensingh, and Noakhali (Birley, 1993). Sengupta reviewed surveillance data for more than 1000,000 kala-azar cases reported in Bengal from 1931-1943 (Sengupta, 1944) and at that time, the most affected districts were Rajshahi, Dinajpur, Jessore, Noakhali and Chittagong (in East Bengal), as well as Murshidabad and Malda (in West Bengal). A large upsurge of kala-azar cases in the 1940s included urban transmission in some neighborhoods of Calcutta (Sengupta, 1947). An intensive control programme aimed at the eradication of malaria was mounted in the 1950s and 1960s throughout the South Asian subcontinent. The effort was based in large part on indoor residual spraying with DDT. The simultaneous drop in kala-azar incidence was widely seen as a collateral benefit (Sanyal, 1985; Birley, 1993). However, within a few years after the end of the eradication effort, kala-azar returned to Bihar (Sengupta, 1975) and to Bengal on both sides of the border (Elias *et al.*, 1989; Addy and Nandy, 1992). Investigators hypothesized that patients with PKDL provided the infection reservoir that initiated foci of resurgence after intensive vector control ended, which was supported by the demonstration that PKDL patients infected a high proportion of laboratory-reared sand flies fed on them (Addy and Nandy, 1992). In Bangladesh, sporadic kala-azar cases were reported in the 1970s, and an outbreak occurred in Pabna district in 1980. There has been kala-azar transmission in Bangladesh every year since then (Elias *et al.*, 1989). Surveillance data are lacking from that period, but in a series of 59 kala-azar

patients reported from 1968-1980, cases were reported from at least 7 districts in Bangladesh (Rahman and Islam, 1983). The districts most affected in the early 1980s were reported to have been Sirajganj, Pabna, Mymensingh, Rajshahi and Tangail (Elias *et al.*, 1989; Birley, 1993). Currently kala-azar cases are being reported from 45 out of 64 districts in Bangladesh. Although kala-azar cases are reported from 45 districts, more than 90 per cent of cases are reported from just 10 districts. From 1994 to 1996, Pabna district reported the highest annual number of kala-azar cases. After 1996, the incidence in Mymensingh overtook that in Pabna and has been continuing to rise since that time. Every year from 2000 to 2012, Mymensingh accounted for more than 50% of the total kala-azar cases reported in Bangladesh and disease transmission in the district appears to be the major focus fueling a sustained epidemic.

1.3 Justification of the study

Visceral leishmaniasis or kala-azar has been a major re-emerging parasitic disease of the socially marginalized population with significant morbidity and mortality for decades in Bangladesh. The current prevalence of kala-azar in our country is estimated to be 45,000 cases with more than 40 million populations are at risk. Out of 64 districts, cases of kala-azar have been reported from 45 districts and certain Northern districts of the country are considered to be hyperendemic for kala-azar. As a consequence, kala-azar elimination programme has been taken by the Government of Bangladesh with a goal to eliminate this disease by 2015. Among the public health important protozoan diseases, much research interest has been invested to explore many essential facts of kala-azar worldwide especially in the endemic countries. As far as the diagnosis of kala-azar is concerned, always there is a dilemma and substantial delay is noted in the final diagnosis. In practice the diagnosis of VL is complex because its clinical features are shared by a host of other commonly occurring diseases. So, there is always a need for development of diagnostic tool for kala-azar, which will be simple, rapid, cost-effective, reliable and versatile in its use. Until recently, the “gold standard” for diagnosis of VL is examination of stained microscope slides for the demonstration of parasite and/or isolation in culture.

However, for parasitological diagnosis to be made, painful invasive procedures like splenic or bone-marrow aspiration are usually done which involves fatal risk and associated with very poor patients' compliance. In this connection, microscopic examination of peripheral blood buffy coat smear for LD bodies could be a minimally invasive and risk free alternative method for parasitological diagnosis but not many studies have been done to explore its usefulness as reliable diagnostic tool. The present study was designed to evaluate and compare the diagnostic accuracy of different tools in respect to gold standard (spleen smear positive for LD body) for kala-azar encompassing parasitological, molecular PCR-based and serodiagnostic methods. Special attention was paid to buffy coat smear as a means of parasitological diagnosis. Molecular techniques based on DNA amplification by PCR using various samples targeting either nuclear DNA or kinetoplast DNA are gradually replacing standard classical methods in many laboratories with very high sensitivity and specificity. The performances of different PCR methods targeting reliable and reproducible DNA markers using buffy coat as sample for PCR amplification were evaluated to compare their diagnostic yields in our setting. Considering many limitations of conventional PCR, Loop-mediated isothermal amplification (LAMP) using buffy coat DNA was performed for the first time in our context to assess its diagnostic performance with the future hope that LAMP can be a potential molecular tool for field use. A comparative evaluation of the serological tests in particular rK39 Immunochromatographic test with parasitological diagnosis in field settings has been done in Africa and India in order to incorporate it as a diagnostic tool for field. Although rK39 ICT was consistently found with high diagnostic sensitivity reported from India but it performed poorly in Africa. Incidentally rK39 ICT is being used as diagnostic tool for kala-azar in our National elimination programme but there has been no good evaluation study conducted in Bangladesh for exploring its status of actual sensitivity and specificity. So, in the context of considerable variation in diagnostic sensitivities and specificities of rK39 ICT among different geographical areas, there is always need for its evaluation to provide conclusive

evidence for its continuing use especially in the field. Considering the merits and demerits of serodiagnostic tools, the present study was designed to incorporate serological tests based on detection of anti-leishmanial antibodies by using both rapid diagnostic technique of Immuno-chromatographic assay (ICT) and more reliable Enzyme linked immunosorbent assay against two different recombinant antigens, rK39 and rK28 besides parasitological and PCR-based molecular diagnostics. The eventual aim of evaluation and comparison of all these diagnostic tools in terms of their sensitivity, specificity and diagnostic accuracy was based on the fact to formulate a sound diagnostic algorithm in our setting. The diagnostic algorithm is expected to be implemented at different health care facilities of our country for better case detection. Further the present study results are expected to enhance kala-azar elimination initiatives of government of Bangladesh.

Although kala-azar has been prevailing in different endemic zones of Bangladesh including Rajshahi for centuries but still there is very limited information available about the genotype of *Leishmania* causing kala-azar in the endemic zones. The association of *Leishmania* species to different clinical forms (VL and PKDL) and their wide geographical distribution in Bangladesh raises the question about the role of genetic diversity in *Leishmania donovani* on the clinical manifestation and epidemiology of the disease. This study was also designed to explore the genotype of *Leishmania* from kala-azar patients attending Rajshahi Medical College Hospital (RMCH), which has been providing treatment of VL and PKDL patients coming from at least 9 nearby districts of endemicity. The genotype and intra or inter species genetic variation of the isolates were explored by using advanced molecular genotyping techniques of ITS1 PCR-RFLP and DNA sequencing of both ITS1 & ITS2 amplicons respectively. Sequencing results were compared with other available Bangladeshi, Indian and reference strains from other VL endemic countries to construct a Phylogenetic tree. The application of these molecular techniques allowed us to better determine the genotype of *Leishmania* causing kala-azar in this endemic region and also to compare their taxonomic status with both native and reference strains.

1.4 Aims and Objectives

This study included following general and specific objectives

1.4.1 General Objective

To evaluate and compare the diagnostic laboratory tests for kala-azar in order to formulate a diagnostic algorithm and to explore the genotype and genetic diversity of *Leishmania* causing kala-azar in patients attending RMCH.

1.4.2 Specific Objectives

- (i) To detect *Leishmania donovani* bodies in splenic and buffy coat smears by direct microscopical examination.
- (ii) To perform leishmania nested polymerase chain reaction (Ln-PCR), Mini-exon PCR, ITS1 and ITS2 PCR for detection of leishmanial DNA in buffy coat.
- (iii) To perform Loop Mediated Isothermal Amplification (LAMP) for detection of leishmanial DNA in buffy coat.
- (iv) To detect anti-leishmanial antibodies in plasma by rapid Immunochromatographic (ICT) test against both rK39 and rK28 antigens.
- (v) To detect anti-leishmanial antibodies in plasma by ELISA against both rK39 and rK28 antigens.
- (vi) To calculate and compare diagnostic sensitivity, specificity and accuracy of different tests to formulate a diagnostic algorithm.
- (vii) To explore the genotype of *Leishmania* by ITS1 PCR-RFLP.
- (viii) To explore the genetic diversity of *Leishmania* by DNA sequencing of ITS1 and ITS2 PCR amplicons.
- (ix) To infer phylogenetic relationship of *Leishmania* by comparing with reference strains.

Chapter 2

REVIEW OF LITERATURE

2.1 Leishmaniasis: global magnitude

The trypanosomatid parasite of the genus *Leishmania* is the aetiological agent of a variety of disease manifestations, collectively known as Leishmaniasis. Leishmaniasis have been considered tropical afflictions that together constitute one of the six entities on the World Health Organization/Tropical Disease Research (WHO/TDR) list of most important diseases (Desjeux, 2001). Leishmaniasis is still one of the world's most neglected diseases, affecting largely the poorest of the poor, mainly in developing countries. Patients and families affected by VL become poorer because of the high direct costs (for example, the costs of VL diagnosis and treatment) and indirect costs (for example, loss of household income) of the disease (Ahluwalia *et al.*, 2003; Rijal *et al.*, 2006). The disease is prevalent through out the tropical and sub-tropical regions of Africa, Asia, Mediterranean, Southern Europe (old world) and South and Central America (new world). Leishmaniasis is not only widely distributed in warm countries, but it is also prevalent in very different topographic areas. It is endemic in rain forests (Bolivia, Brazil), deserts (Middle East, North Africa), in the countries bordering the Mediterranean Sea and also in elevations of several thousand metres (Peruvian Andes, Ethiopian highlands). The disease is endemic in 88 countries of 5 continents with a total of 350 million people at risk and 12 million cases. Of the 88 endemic countries, 22 are in the New World and 66 in the Old World with an estimated incidence of 1-1.5 million cases of cutaneous Leishmaniasis (CL) and 0.2-0.4 million

cases of visceral Leishmaniasis (Alvar *et al.*, 2012). Despite this widespread geographic distribution, human leishmaniasis is often very focal within an endemic area, leading to ‘hotspots’ of disease transmission (Desjeux, 2001). Leishmaniasis remains a major public health problem today despite the vast amount of research conducted on *Leishmania* pathogens. It has proved difficult to predict the exact scale of the impact of the leishmaniasis on public health, since many cases go unreported or misdiagnosed. Environmental changes such as deforestation, urbanization, migration of non-immune people to endemic areas and HIV-VL coinfections have led to an increase in the incidence of leishmaniasis. Migration from non-endemic to endemic areas is a major risk factor for the spread of VL as these people on their return can spread the disease in a non-immune population. Thus leishmaniasis is linked to poverty, economic development and various environmental changes (Sundar and Chakravarty, 2012).

2.2 Prevalence of kala-azar in Bangladesh

Kala-azar is endemic in different parts of Bangladesh for centuries. Currently it has been reported from 45 districts out of 64 with Mymensingh is the most affected area. Kala-azar endemic districts in Bangladesh are shown in Fig. 2.1. From 1999 through October 2012, a total of 76,830 kala-azar cases and 228 deaths were reported to the Communicable Disease Control (CDC) unit of Directorate General of Health Services (DGHS), Government of Bangladesh (Fig. 2.2). The kala-azar data collated by the DGHS result from passive surveillance at the level of the thana (sub district) health complexes (THC). Only kala-azar patients diagnosed at the THCs are included, and the data are widely believed to represent a substantial underestimate. Factors that change over time, such as the availability or lack of diagnostic tests and anti-leishmanial drugs, may alter sensitivity and specificity of diagnosis and the proportion of kala-azar patients who attend the THC. Nevertheless, the data have broad coverage and are useful to examine geographic distribution and trends over time. Annual total number of kala-azar cases estimated for

Bangladesh, India and Nepal were 36,500, 270,900 and 12,600 respectively (Rijal *et al.*, 2006; Joshi *et al.*, 2008). In Bangladesh there was a trend of rising incidence from 4,283 in 2001 to 9,379 in 2006 (Fig. 2.2). Although kala-azar cases are reported from 45 of 64 districts of Bangladesh, more than 90 per cent cases were reported from just 10 districts (Fig. 2.3). From 1994 to 1996, Pabna district reported the highest annual number of kala-azar cases. After 1996, the incidence in Mymensingh overtook that in Pabna, and has continued to rise since that time. Every year from 2000 to 2012, Mymensingh accounted for more than 50% (Fig. 2.3) of the total kala-azar cases reported in Bangladesh, and the disease transmission in that district appears to be the major focus fueling a sustained epidemic. In Mymensingh district, only 5 of 12 thanas reported kala-azar cases in recent years. Using the population of the respective thana as the denominator, the incidence of kala-azar in Fulbaria thana ranged from 30 to 33/10,000/year since 2000, while that in Trishal, the next most affected thana, ranged from 21 to 26/10,000/year. Over the same period of time, the incidence in the other 3 endemic thanas, Bhaluka, Muktagacha, and Goforgaon, ranged from 5 to 15 cases/10,000/year. For the 5 endemic thanas of Mymensingh, the mean annual reported incidence since 2000 was 17/10,000/year, compared to 8.3/10,000/year when the total district population was used (Alam *et al.*, 2009c).

One international expert in the field estimates that the number of cases reported in surveillance data is likely to be at least a 5-fold underestimate (Bern and Chowdhury, 2006). Based on currently available information, it is not possible to assess the degree of underreporting with precision, nor the extent to which this varies from one district to another. The estimate of 5-fold underreporting would imply that the true incidence of kala-azar in Bangladesh is closer to 40,000 to 45,000 per year. The area most affected by kala-azar in Bangladesh since 1994 has generally encompassed the center and the northwestern quarter of the country, with endemic districts reaching to the border with West Bengal; the estimated population at risk is said to be 20 million. Nevertheless, both the recent surveillance data and the historical record clearly indicate that the area

of potential risk for visceral leishmaniasis is much larger, stretching from Noakhali and Patuakhali on the Bay of Bengal to Chittagong in the southeast and the border with Assam in the north.

Fig. 2.1 Prevalence of kala-azar cases in Bangladesh (Source: CDC, DGHS)

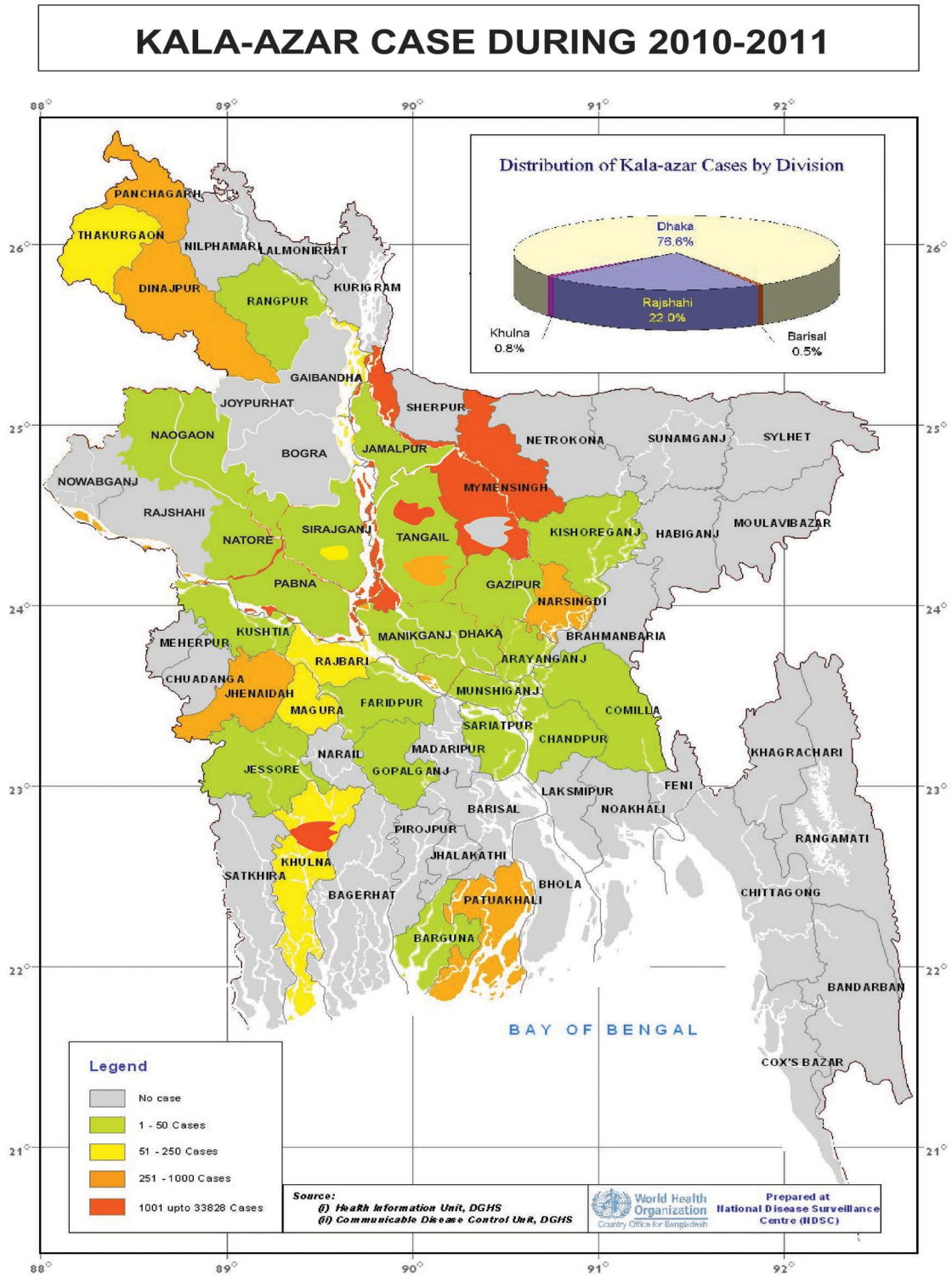

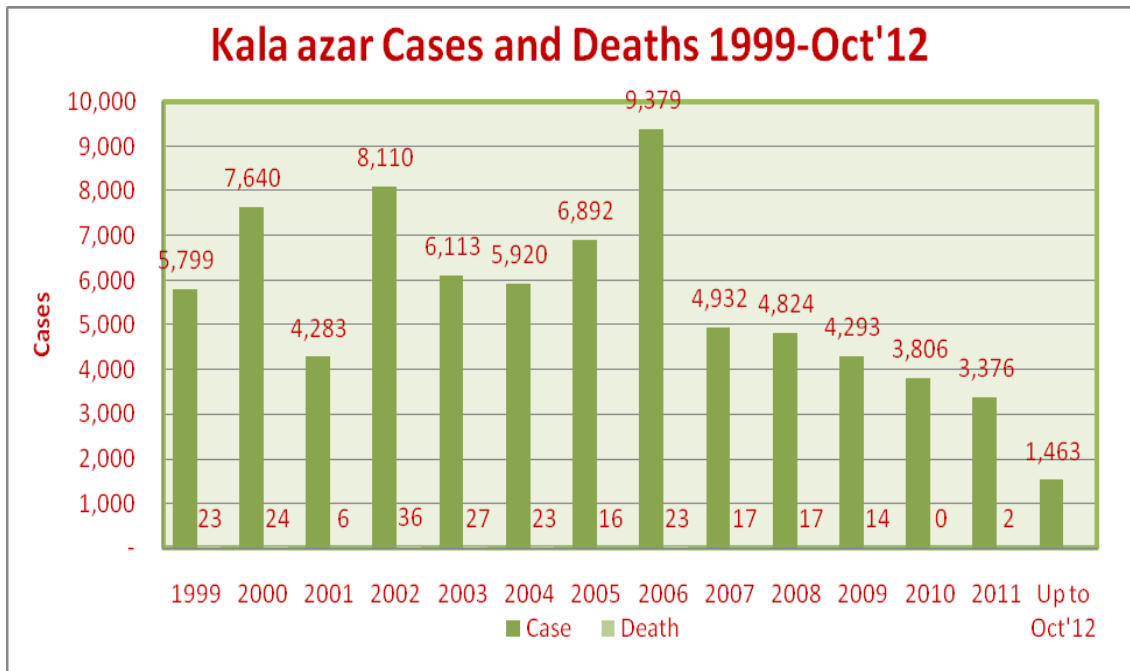

Fig. 2.2 Kala-azar cases and deaths from 1999 to October 2012 in Bangladesh (Source: CDC, DGHS)

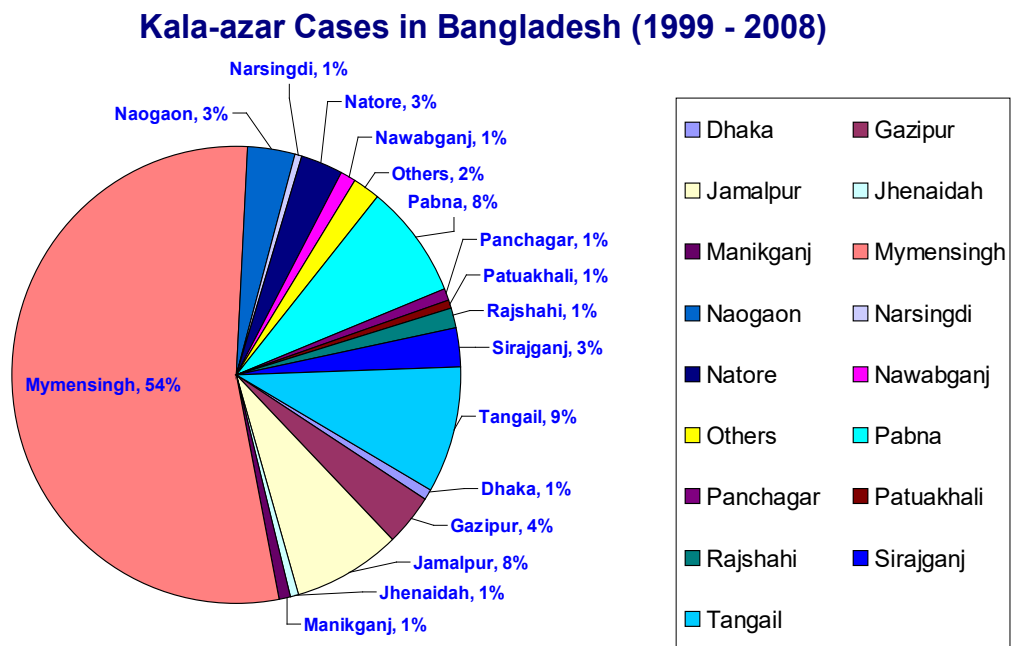

Fig. 2.3 District-wise frequency of kala-azar cases in Bangladesh (Source: CDC, DGHS).

2.3 Visceral leishmaniasis

Visceral leishmaniasis (VL) is also known as 'kala-azar'. The aetiological agents of VL belong to the *Leishmania donovani* complex: *L. donovani*, the causative organism of VL in the Indian subcontinent and Africa; *L. infantum* (*L. chagasi*) which causes VL in the Mediterranean basin, Central and South America (Sundar and Chakravarty, 2012). The old world species are transmitted by the sandfly vector *Phlebotomus* species. Humans, wild animals and domestic animals are known to act as reservoir hosts. *Lutzomyia longipalpis* is the only sandfly vector that has been implicated in the transmission of the new world species of visceral leishmaniasis where wild and domesticated dogs are known to serve as reservoir hosts (WHO, 1990). The annual incidence of visceral leishmaniasis is estimated to be 0.2-0.4 million cases with more than 90% occurring in Bangladesh, India, Nepal, northeast Brazil, Sudan and Ethiopia. In the Mediterranean basin, 1.5-9% of AIDS patients develop visceral leishmaniasis and 25-70% of the adult VL cases are related to HIV infection. Both the new world and the old world form of the disease display similar symptoms and are often complicated by secondary infections (Alvar *et al.*, 2008).

2.3.1 Definition

Visceral leishmaniasis was first described in 1903, by Leishman and Donovan. The causative agent was named *Leishmania donovani* after the names of these two scientists.

Visceral leishmaniasis or kala-azar is a chronic systemic illness caused by an obligate intracellular protozoan parasite *Leishmania donovani* and its subspecies. It affects the organs of reticuloendothelial system throughout the body (Maegraith, 1989). The disease is prevailing in the rural population with more affection for the young males and if untreated, has a mortality rate of almost 100% (Chowdhury *et al.*, 1993a, Park & Park, 2000).

2.3.2 Aetiology

Since the creation of the genus *Leishmania* by Ross in 1903, the number of species described has constantly increased (Ross, 1903). Human infection is caused by some 21 species out of 30 that infect mammals. These include the *L. donovani* complex with 3 species (*L. donovani*, *L. infantum*, and *L. chagasi*); the *L. mexicana* complex with 3 main species (*L. mexicana*, *L. amazonensis*, and *L. venezuelensis*); *L. tropica*, *L. major*, *L. aethiopica*, and the subgenus *Viannia* with 4 main species (*L. (V.) braziliensis*, *L. (V.) guyanensis*, *L. (V.) panamensis*, and *L. (V.) peruviana*). The different species are morphologically indistinguishable, but they can be differentiated by isoenzyme analysis, molecular methods, or by monoclonal antibodies.

Visceral leishmaniasis is typically caused by the *Leishmania donovani* complex. Rarely VL can be caused also by *L. tropica*. In India, *L. tropica* has been isolated from 4 patients suffering from classical kala-azar (Sacks *et al.*, 1995). The clinical features of VL caused by different species are different and each parasite has a unique epidemiological pattern.

- *L. donovani* causes infection in India, East Africa and parts of China (Bahr and Bell, 1987)
- *L. infantum* causes infection in Mediterranean area, Middle East, parts of sub-Saharan Africa, China and South America
- *L. chagasi* causes infection in children in Latin America, where lymphadenopathy is a dominant clinical feature.

Old world infections are mostly anthroponotic, i.e. *Leishmania* passes from one human to another (rodents and dogs may serve as reservoirs in some areas of Africa) and is caused by *L. donovani* and *L. infantum*. On the other hand, new world infections caused by *L. chagasi* are zoonotic with dogs, foxes and marsupials serving as reservoir hosts.

2.3.3 Parasite morphology

The parasite has two morphological stages in its life cycle.

(i) Amastigote stage (Aflagellar stage)

The parasite at this stage resides in the cells of the reticuloendothelial system of vertebrate hosts (man, dog and hamster). It is a round or oval body measuring 3 to 5 μm along the longitudinal axis. Cell membrane is delicate. Nucleus measures a little less than 1 μm in diameter. It is usually situated in the middle of the cells or along the side of the cell-wall. Kinetoplast comprises a DNA containing body and a mitochondrial structure lies tangentially or at right angles to the nucleus. Root of flagellum is represented by axoneme or rhizoplast like delicate filament (Ross, 1903)

(ii) Promastigote stage (Flagellar stage)

This stage of the parasite is only encountered in cultures and in insect vectors (sandflies). The fully developed ones are long slender spindle-shaped bodies measuring 15 to 20 μm in length by 1 to 2 μm in breadth. Nucleus is situated centrally and the kinetoplast lies transversely near the anterior end. Flagellum may be of the same length as the body or even longer, projecting from the front.

The kinetoplast is found in all protozoa of the order kinetoplastidae (eg. *Leishmania*, *Trypanosoma*, *Crithidia*). It is a rod-shaped mitochondrial structure consisting of a DNA network, kinetoplast DNA (kDNA) of 5000-10,000 minicircles of about 2kb size each and 25-250 maxicircles of approximately 30kb. Together these constitute the mitochondrial genome. The function of the kinetoplast has not been clear until recently. It was found that maxicircles encode for mitochondrial ribosomal RNAs, while the minicircles play a role in the editing process of these mRNAs (Shlomai, 1994).

2.3.4 Life cycle of *L. donovani*

L. donovani completes its life cycle in two different hosts. Leishmaniasis is transmitted by the bite of female phlebotomine sandflies. The sandflies inject the infective stage, promastigotes, during blood meals (1). Promastigotes that reach the puncture wound are phagocytized by macrophages (2) and transform into amastigotes (3). Amastigotes multiply in infected cells and affect different tissues, depending in part on the *Leishmania* species (4). This originates the clinical manifestations of Leishmaniasis. Sandflies become infected during blood meals on an infected host when they ingest macrophages infected with amastigotes (5,6). In the sand fly's midgut, the parasites differentiate into promastigotes (7), which multiply and migrate to the proboscis (8).

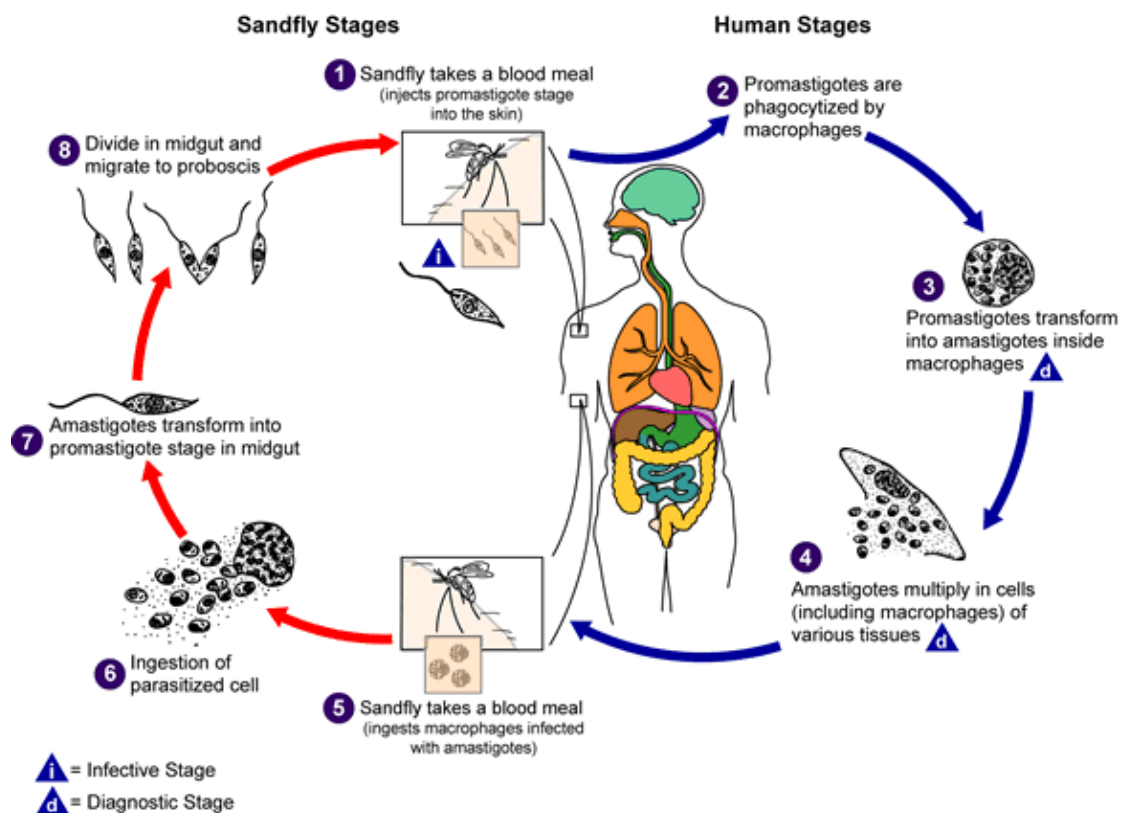

Fig. 2.4 Life cycle of *L. donovani* (Source: US Center for Disease Control and Prevention)

2.4 Vector

Species and subspecies of *Phlebotomus* and *Lutzomyia* are the only proven vectors of leishmaniasis. The natural transmission of *L. donovani* from man to man is carried out by the bite of certain species of infected female sandfly, belonging to the genera *Phlebotomus* and *Lutzomyia*. Female *Phlebotomus argentipes* is the vector of kala-azar in Bangladesh. Its habitat is restricted to domiciliary and peridomestic areas. Overcrowding, ill ventilation and accumulation of organic matter in the environment facilitate the transmission of vector. Primitive housing and low standards of hygiene increase the risk of transmission in peridomestic areas.

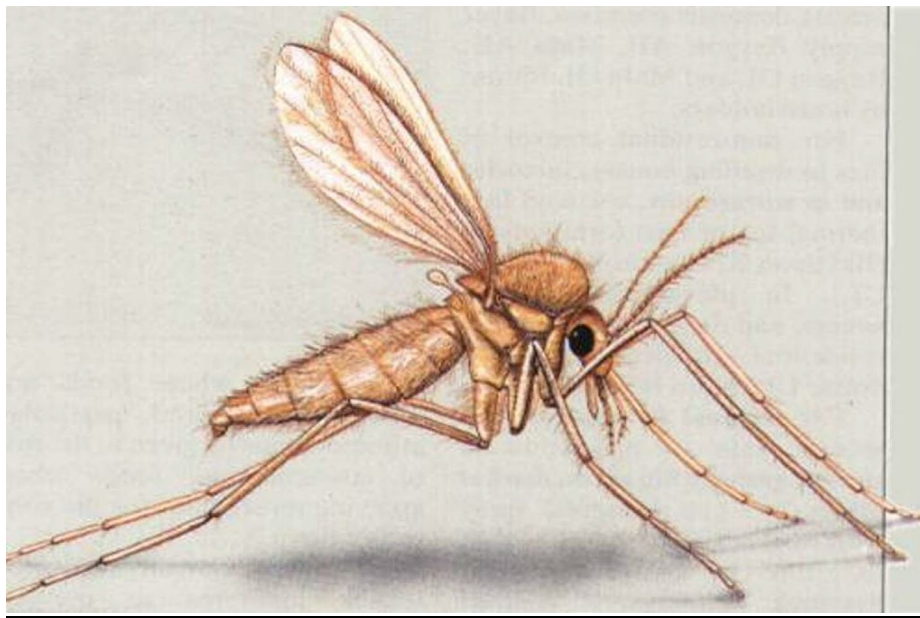

Fig. 2.5 Sandfly (*Phlebotomus argentipes*)

2.5 Modes of Transmission

Transmission of kala-azar is caused by the bite of infected female sandfly of the genera *Phlebotomus* and *Lutzomyia*. Some of the species feed on man and also on a variety of cold-blooded animals. A sandfly becomes infected 14-18 days after the ingestion of the infected blood meal and remains infected throughout its lifetime capable of infecting several persons (Cheesbrough, 1999).

Transmission of visceral leishmaniasis may take place by contamination of bite wound or by contact when the insect is crushed during the time of biting (Park and Park, 2000). In the context of prevalence of HIV infection, the traditional anthroponotic pattern of VL transmission is likely to be modified and very rarely transmission of *Leishmania* has been described by alternative means that are also shared by HIV transmission (Sinha *et al.*, 2005).

Accidental inoculation of parasites during laboratory works may result in leishmaniasis (Rosenthal *et al.*, 1998) and transmission by blood transfusion has also been recorded (Kostman *et al.*, 1963). Congenital infection from an infected mother to her foetus may occur rarely due to placental defect (Bahr and Bell, 1987; Haque *et al.*, 2010). Transmission during coitus was also recorded (Chatterjee, 1980) and a case of fatal leishmaniasis was noted in renal transplant patient (Vanorshovan *et al.*, 1979).

2.6 Pathogenesis

Promastigotes are inoculated into the wound produced by the feeding sandfly. The cells are broken by the proboscis and the saliva inoculated into the wound attracts mononuclear phagocytes (macrophages) and other white cells to the area. Certain macrophages can directly kill the parasites while others require prior stimulation to attain the capability. Only resident (local) macrophages are suitable for the establishment of the infection.

The parasites invade the cells of the reticuloendothelial system, such as bone marrow, spleen and the liver. Tropism of the parasites is thought to be dependent, in part, on the optimal temperature of growth of the amastigotes. Parasites that grow best at 37°C cause the visceral manifestation of the disease.

The viscerotropic species are carried through the infected macrophages circulating in the blood or lymph induce hyperplasia of organs of reticuloendothelial system. Many of these cells become heavily parasitized. The spleen is grossly enlarged and its cells are packed with amastigotes. The splenic pulp is greatly increased in amount and friability with consequent

possibility of many infarcts. Haemopoietic activities in the bone marrow, particularly the leukoblastic elements are disturbed seriously resulting leukopenia. The marrow reveals a considerable replacement of the haemopoietic tissues by the proliferated and parasitized macrophage cells. A progressive and profound anaemia may occur in kala-azar was thought in the past to be due to marrow hypoplasia resulting from crowding out of erythropoietic tissue by proliferation of parasitized reticuloendothelial cells. More careful studies of bone marrow however revealed that the erythropoiesis is hyperplastic. Haemolysis as a possible mechanism (red cells sequestered and destroyed in the spleen) is now thought to play an important role in the production of anaemia in kala-azar. The presence of erythrocyte with a short life span (the survival time of red cells reduced by 50%), anti-red cell antibody, antibodies against white cells and platelets suggests an autoimmune basis for the pancytopenia observed in kala-azar (Chatterjee, 1980).

There are several mechanisms whereby *Leishmania* overcome the microbiocidal conditions of the monocyte phagolysosome, which include proton pumps to balance pH and enzymes to detoxify oxygen metabolites and other leishmanicidal products (Kamhawi, 2000). However, the main mechanism by which *Leishmania* is killed is increased production of oxygen metabolites in macrophages stimulated by lymphokines from the activated lymphocytes generated during the immune response. Later on activated macrophages and helper T lymphocytes are recruited to the site of infection through events of cell-mediated immune response.

Cytokine responses: Pathogenesis appears to be related to T-cell cytotoxicity and control of VL depends on the magnitude of T helper 1 and multicytokine responses early in the course of infection. During progressive infection in mice, CD4⁺ Th2 cells expand and secrete interleukin-4 (IL-4), resulting in polyclonal B-cell activation. Later, fully established VL is associated with cellular anergy. Inappropriate antigen presentation and communication between the antigen-

presenting cells and T cells, as well as the induction of IL-10 and IL-4 might explain this anergy.

In endemic areas, infected subjects may or may not develop classic signs and symptoms. Capacity to produce IL-2 and interferon-gamma (IFN- γ) (Th1 response) is associated with asymptomatic or subclinical self-healing infection. In contrast, individuals whose lymphocytes do not proliferate and, thus, do not produce IFN- γ when stimulated by *Leishmania* antigen, will develop acute VL or a subclinical infection that progresses to classical disease. Immunological abnormalities could be found in monocyte and T-cell function, such as diminished production of tumour necrosis factor-alpha (TNF- α) and IL-1 after lipopolysaccharide (LPS) or *Listeria* stimulation. There is absence of delayed-type hypersensitivity to *Leishmania* antigen and a decreased capability of T-cells to activate macrophages and kill *Leishmania*. All these abnormalities may account for parasite multiplication and progression of the disease. By the antigen specific lymphocyte population, plasma levels of IFN- γ , IL-12, p40, IL-18, IL-15, interferon-gamma inducible protein (IP-10) and monokine induced by IFN- γ are markedly elevated in symptomatic VL patients as compared to individuals with asymptomatic infection. Significant decrease of plasma levels of IFN- γ and all other mediators has been observed after treatment of such patients (Hailu *et al.*, 2004). *L. donovani* amastigote components have been shown to induce the production of colony-stimulating factors in experimental infection and thus it may play an important role in the pathogenesis of VL (Singal and Singh, 2005).

2.7 Host parasite relationship

It is obvious that the clinical manifestations or outcome of infection caused by *Leishmania* are determined by interactions between the host and parasite, which are governed by their genomes. But unfortunately in human leishmaniasis, the host population is heterogeneous and the parasites are not clonal, and this makes it difficult to dissect out the relative contributions of the parasite and the host. However, the outcome of infection is largely dependent

on the ability of the host to mount a protective T-helper 1 (Th1) response versus the ability of the parasite to evade and manipulate the host's immune system (Liese *et al.*, 2008). Macrophages, dendritic cells, T-helper cells (CD4+ T cells), cytotoxic T cells (CD8+ T cells), natural killer (NK) cells and cytokines are all, in one way or another are considered to play important roles in the immune response to *Leishmania* infection (Vanloubbeeck and Jones, 2004).

Much of current knowledge of the contribution of host genetics to the pathogenesis of leishmaniasis comes from mouse models using cloned parasite lines and inbred mice, but these systems have many limitations and serve only as guides for exploration the facts in humans. During its development in the sandfly gut as a motile promastigote, a biochemical modification of the parasite's glycolipid coat occurs. This very transformation protects the parasite from rapid lysis via the mammalian complement system. Further, in an elegant example of molecular mimicry, the parasite uses the host complement receptor to gain access into the hostile environment of the phagolysosome and thrives. Depending on the species of the parasite, resistance to infection is generally associated with a T-helper 1 immune response that activates macrophages to kill intracellular *Leishmania* in a nitric oxide-dependent manner. Conversely, disease progression is generally associated with a T-helper 2 response that activates humoral immunity. It is expected that with the advent of the complete sequence of the human genome, it would facilitate the mapping of human genes controlling susceptibility to leishmaniasis. On the other hand, the elucidation of the complete sequence of the *Leishmania* genome should facilitate the discovery of genes which determine parasite virulence (Blackwell, 1997; Ivens and Smith, 1997). In the search of susceptibility genes, several host genes have been identified using genetic approaches in both mice and humans. The early discovery that susceptibility to *L. donovani*, *Salmonella enterica* serovar Typhimurium, and *Mycobacterium bovis* was partly controlled by a single gene on mouse chromosome 1 led to the isolation from humans and mice of the gene encoding natural resistance-associated macrophage protein 1 (*NRAMP1*) (Blackwell, 1996a and 1996b). Disappointingly, recent data tend to

indicate that this gene may not play a role in human leishmaniasis, in contrast to the wealth of prosperous data obtained in mice. The precise biological function of NRAMP1 is not yet known, but a closely related protein, NRAMP2, is a transporter of iron from endosomes to the cytoplasm (Fleming *et al.*, 1997). While no association has been seen in humans between allelic forms of NRAMP1 and leishmaniasis, an understanding of its action may still help explaining the peculiar ability the parasite has of surviving the harsh environment of the phagosome.

For a disease in which healing and recovery depend on the induction of cell-mediated immunity, it is not surprising that the major histocompatibility complex (MHC) has been implicated intimately in its susceptibility. In mouse model, it was shown that different MHC haplotypes were associated with different degrees of susceptibility to visceral leishmaniasis. A role for the MHC in human cutaneous leishmaniasis has also been described in and is supported by a genetic linkage study in mice (Leclercq *et al.*, 1996). These data add to the wealth of evidence supporting a role of the MHC in resistance to a variety of infectious diseases including leprosy, schistosomiasis, malaria, hepatitis B infection and the progression of HIV infection to AIDS (Mann *et al.*, 1998). The mouse model of infection with *Leishmania major* helped to explore the cellular basis of this phenomenon. Heinzl (1989) correlated that the outcome of infection is determined by the nature and magnitude of T cells and cytokine response early in infection (Heinzl, 1989). Environment produced by these different cytokines released by two subsets of T helper cells in turn recruits and activates different immune effector cells (Roberts *et al.*, 2000). Moreover, once established, these responses become mutually exclusive to a large extent.

In summary, the current data indicate that susceptibility to leishmaniasis is controlled by many genes, including TNF, the MHC, NRAMP1, and others of unknown function. Susceptibility, resistance, and disease patterns probably depend on complex interactions between these genes (Handman, 2001).

2.8 Clinical manifestations of kala-azar

Visceral leishmaniasis may be endemic, sporadic or epidemic with different clinical features in each situation. In areas endemic for VL, the disease tends to be chronic and children especially are affected. The incubation period is highly variable. The disease can appear anything between 10 days to over one year, even longer incubation periods have been documented (WHO, 1990). The symptoms of VL include high undulating fever often with two or even three peaks in 24 hours and drenching sweats which can easily be misdiagnosed as malaria. Other symptoms include malaise, shivering or chills, rigors, weight loss, fatigue, poor appetite, burning feet, insomnia, joint pain, epistaxis and discomfort in the left hypochondrium. Cough and diarrhoea occur less frequently. The common clinical signs are non-tender splenomegaly, with or without hepatomegaly, wasting and pallor of mucous membranes, lymphadenopathy may be present. Darkening of the skin of the face, hands, feet and abdomen (black sickness) is often found in Indian kala-azar. Signs of malnutrition like oedema, skin and hair changes etc. also develop (Sarker *et al.*, 2003a; Mondal *et al.*, 2010).

2.9 Post Kala-azar Dermal Leishmaniasis (PKDL)

Post kala-azar dermal leishmaniasis (PKDL) is a sequel of treated or spontaneously cured kala-azar appears in a few cases. In the Indian subcontinent, it occurs only in a small proportion of patients, 6 months to several years after an episode of VL. There may be no previous history of kala-azar in many cases. It arises due to incomplete elimination of the parasites and many recrudescences in the skin giving rise to PKDL. These cases are considered as potential reservoirs of infection in the community (Thakur and Kumar, 1992). PKDL usually present in one of the following three forms;

(i) ***Hypopigmented patches***: These are earliest dermal lesions. The usual sites of distribution of these small measles like lesions are the trunk and extremities;

the face is less commonly affected. The loss of pigmentation is not as complete as is found in the depigmented patches of tuberculoid leprosy.

(ii) *Erythematous patches*: These are also early lesions, which appear on the nose, cheeks and chin, often having a butterfly distribution. They are very photosensitive, becoming prominent towards the middle of the day.

(iii) *Nodular lesion*: These replace the earlier lesions and occasionally appear from the very beginning. The nodules are generally found on the skin and rarely on the mucous membrane of the tongue and eyes. They appear mostly on the face but may appear on any part of the body. The lesions are usually self-limiting, however, those do not heal spontaneously within six months have to be treated with standard regimen of injection Sodium Stibogluconate (Zijlstra *et al.*, 2003).

2.10 Laboratory diagnosis of visceral leishmaniasis

There is no substitute for laboratory diagnosis of a human disease and more so for the microbial diseases. Clinical and epidemiological findings of various forms of leishmaniasis can help to develop a presumptive diagnosis only but definitive diagnosis really rests upon the laboratory findings. Clinical features of VL are non-specific and can be easily mistaken for any other common febrile illness such as malaria, enteric fever, tuberculosis, etc. VL is fatal if untreated, therefore, highly sensitive diagnostic tests are needed which should also be highly specific as most of the current anti-leishmanial drugs are toxic. Besides being highly sensitive and specific, an ideal test should be simple and affordable. There are many diagnostic options for visceral leishmaniasis but the gold standard remains in the demonstration of parasite. Laboratory diagnosis of visceral leishmaniasis can be made by:

- (a) demonstration of parasite in tissues of relevance by light microscopic examination of the stained specimen, in-vitro culture or animal inoculation.

- (b) detection of parasite DNA in tissue samples.
- (c) immunodiagnosis by detection of parasite antigen in tissue, blood or urine samples, by detection of nonspecific or specific anti-leishmanial antibodies (immunoglobulin), or by assay for *Leishmania*-specific cell-mediated immunity.

2.10.1 Parasitological diagnosis

Microscopy

The frequently used method for the diagnosis of VL has been the demonstration of parasites in splenic or bone marrow aspirate. The presence of the parasite in lymph nodes, liver biopsy or aspirate specimens or the buffy coat of peripheral blood can also be demonstrated. Amastigotes appear as round or oval bodies measuring 2 to 4 μm in length and are found intracellularly in monocytes and macrophages. Smears stained with Giemsa or Leishman stain, the cytoplasm appears pale blue, with a relatively large nucleus that stains red. In the same plane as the nucleus, but at a right angle to it, is a deep red or violet rod-like body called a kinetoplast. After identification, parasite density in the spleen smear can be scored microscopically by means of a logarithmic scale ranging from 0 (no parasite per 1,000 oil immersion fields) to 6 (>100 parasites per field). Estimation of parasite density allows the response to treatment to be evaluated, and slow responders can be distinguished from non-responders by using sequential smears (Chulay and Bryceson, 1983). The sensitivity of the bone marrow smear is about 70% or lower (Boelaert *et al.*, 1999; Sarker *et al.*, 2004). Splenic aspirate, though associated with risk of fatal haemorrhage in inexperienced hands, is one of the most valuable methods for diagnosis of kala-azar with a sensitivity of 93.1%–98.7% (Kager and Rees, 1983; Zijlstra *et al.*, 1992; Sarker *et al.*, 2004). After the procedure the patient must be observed in the recumbent position for a minimum of 8 hours in a facility where blood transfusion is available. Splenic aspiration is not possible in non-cooperative children, is difficult in those without a palpable spleen and

is contra-indicated in persons with active bleeding, thrombocytopenia, severe anaemia or jaundice, those in a moribund state, non-cooperative individuals and pregnant women. Amastigotes have also been demonstrated in liver biopsy and lymph node aspirate smears with 50-80% and 56% sensitivities respectively (Zijlstra *et al.*, 1992).

Detection of LD bodies in peripheral blood buffy coat smears is an alternative and minimally invasive procedure for the parasitological diagnosis of VL. When blood is settled in presence of an anticoagulant, the WBCs are deposited and concentrated in buffy coat at the interface of RBCs and plasma. Since buffy coat contains concentrate of WBC including monocytes, so there is always a higher chance of demonstration of amastigote form of LD body in the buffy coat smear and its sensitivity ranged from 50 to 99% (Monica, 1998). Diagnostic sensitivities of buffy coat smear were evaluated recently in three Bangladeshi studies and were found to be ranged from 74% to 93%, (Shamsuzzaman *et al.*, 2007; Roy *et al.*, 2009; Salam *et al.*, 2012). There are clear advantages of buffy coat over conventional smears for parasitological diagnosis in terms of minimal invasiveness, simplicity and cost-effectiveness. Further, as an alternative parasitological tool, it has the potential for point-of-care test.

Tissue specimens can also be subjected to histology and the presence of parasites can be demonstrated by standard haematoxylin and eosin stain. The sensitivity of the test can be increased by staining the specimen with fluorescent dye-tagged antibodies to the surface receptors of the parasite. Fluorescent dye-conjugated monoclonal antibodies are also used for speciation of the parasite.

Culture

Parasite culture can improve the sensitivity of detection of parasite, but *Leishmania* culture is rarely needed in routine clinical practice. However, cultures are required for (i) obtaining a sufficient number of organisms to use an antigen for immunological diagnosis and speciation, (ii) obtaining parasites

to be used in inoculating susceptible experimental animals, (iii) in-vitro screening of drugs and (iv) accurate diagnosis of the infection with the organism (as a supplement to other methods or to provide a diagnosis when routine methods have failed) (Sundar and Rai, 2002a). The culture media may be monophasic (Schneider's insect medium, M199, or Grace's medium) or diphasic (Novy-McNeal Nicolle medium and Tobies medium). Hockmeyer's medium, which is Schneider's commercially prepared culture medium supplemented with 30% heat-inactivated foetal calf serum with 100 IU of penicillin and 100 µg of streptomycin is simple to use and satisfactory for diagnosis of VL but it is expensive (Hockmeyer *et al.*, 1981).

Culture tubes are inoculated with 1 to 2 drops of bone marrow or splenic aspirate and incubated at a temperature between 22 and 28°C. The tubes are examined weekly for the presence of promastigotes by phase-contrast microscopy or by wet mount of culture fluid for 4 weeks before being discarded as negative. Blood can also be used to isolate the parasite, but the method is slow and takes longer. Contamination of the culture media by bacteria or yeast species or other fungi usually complicates the culture but can be avoided by use of good sterile techniques and by the addition of bactericidal and antimycotic agent (Schur and Jacobson, 2001).

2.10.2 DNA-based molecular diagnosis

Microscopy and culture for *Leishmania* have the limitations of low sensitivity and are time consuming. The immunological methods fail to distinguish between past and present infections and are not very reliable in immunocompromised patients. To address these limitations, molecular approach being capable of detecting nucleic acids unique to the parasite is gaining importance in the recent years. The development of polymerase chain reaction (PCR) in mid 1980s has provided a powerful approach to the application of molecular biology techniques for detection of both parasite DNA and RNA. The method is based on the enzymatic amplification of selected DNA sequences, which are made visible by gel electrophoresis in its

conventional method. The use of fluorogenic real time PCR using SSU-rRNA gene added with complete automation has made quantification of parasite burden possible (Wortman *et al.*, 2001).

Although the PCR is able to detect a single copy of target DNA, repeat sequence are used to improve its sensitivity. Molecular probes using kinetoplast DNA (kDNA), ribosomal RNA (rRNA), mini exon derived RNA (medRNA) and genomic repeats have been evaluated and used to a much higher sensitivity and specificity (Katakura *et al.*, 1998). Many different types of samples can be processed by PCR including blood spots, buffy coat, tissue samples, splenic and bone marrow aspirates (Adhya *et al.*, 2002; Salam *et al.*, 2010). Primers designed to amplify conserved sequences found in minicircles of kDNA of different species of *Leishmania* were tested in various tissues of relevance. Such a target was eminently suitable because the kinetoplast is known to possess thousands of copies of minicircle DNA.

For the last two decades, PCR-based diagnostic for VL have been reported by a number of investigators with a wide range of sensitivities and specificities (Andresen *et al.*, 1997; Mortarino *et al.*, 2004; Salam *et al.*, 2010). PCR has a high potential which can detect even single parasite (Harris *et al.*, 1998). In some studies, PCR was found to be more sensitive than microscopy (Andresen *et al.*, 1997) and it proved to be more sensitive (~100%) when compared to serology (Ashford *et al.*, 1995). However, its sensitivity for the detection of *Leishmania* DNA in the blood of parasitologically proven VL cases was 70% to 96% (Osman *et al.*, 1997). PCR assay with buffy coat preparations to detect *Leishmania* was 10 times more sensitive than that with whole-blood preparations, and particularly good results were obtained when proteinase K-based methods were used. Proteinase K-based PCR was able to detect 10 parasites/mL (Lachaud *et al.*, 2001). Besides being a highly sensitive and specific tool for diagnosis of both VL and PKDL and a useful method for species identification, PCR can also be used to distinguish between relapse and reinfection in treated VL patients (Minodier *et al.*, 1997). PCR could also prove

to be an important tool in assessing the success of VL treatment (Maurya *et al.*, 2005; Salam *et al.*, 2010).

2.10.3 Loop-mediated isothermal amplification (LAMP)

"LAMP" which stands for loop-mediated isothermal amplification is a simple, rapid, specific and cost-effective nucleic acid amplification method. It was developed as a novel method to amplify DNA with rapidity and high specificity under an isothermal condition (Notomi *et al.*, 2000; Nagamine *et al.*, 2002). LAMP is characterized by the use of 4 different primers specifically designed to recognize 6 distinct regions on the target gene and the reaction process proceeds at a constant temperature using strand displacement reaction. Amplification and detection of gene can be completed in a single step, by incubating the mixture of samples, primers, DNA polymerase with strand displacement activity and substrates at a constant temperature (about 65°C) by using basic equipment such as a heat block or water bath. Moreover, because LAMP reactions cause turbidity in the reaction mixture proportional to the amount of amplified DNA, identification of positive or negative results is easily to make visually (Mori *et al.*, 2001). It provides high amplification efficiency, with DNA being amplified 10^9 - 10^{10} times in 15-60 minutes. Because of its high specificity, the presence of amplified product can indicate the presence of target gene.

Shorter reaction time, a lack of requirement of sophisticated equipment, and visual judgment of positivity based on the turbidity of reaction mixture make the LAMP technique as a better alternative to a conventional PCR, especially under field conditions. LAMP assay has been reported highly sensitive and specific to detect *L. donovani* kinetoplast DNA from blood samples from patients with VL and comparable with conventional and nested PCRs (Takagi *et al.*, 2009; Khan *et al.*, 2012).

2.10.4 Immunodiagnosis

Antigen detection

Antigen detection is an excellent method of diagnosing an infection and is more specific than antibody-based immunodiagnostic tests which is expected to broadly correlate with the parasite load. De Colmenares *et al* (1995) from Spain have reported two polypeptide fractions of 72-75 kDa and 123 kDa in the urine of kala-azar patients with sensitivity and specificity of the 72-75 kDa fractions were found to be 96% and 100% respectively (De Colmerares *et al.*, 1995). A leishmania-specific stable non-protein antigen has been demonstrated in the urine of active VL patients using a latex agglutination test (KAtex). The antigen in case of VL is detected quite early during the infection and the results of animal experiments suggest that the amount of detectable antigen tends to decline rapidly following chemotherapy (Kalon Bio, UK, 2005). Detection of antigen has been found useful in the diagnosis of VL with deficient antibody production such as in AIDS patients. Evaluation of KAtex from India showed 87% sensitive and 99% specific (Sundar *et al.*, 2005), while its sensitivity ranged from 75% to 95% and specificity from 95% to 100% observed in a few Bangladeshi studies (Salam *et al.*, 2010; Salam *et al.*, 2011).

Antibody detection

For several decades, nonspecific serological methods which depend upon raised globulin levels have been used in the diagnosis of VL. Some of the tests used for detecting these nonspecific immunoglobulins are Napier's formol gel or aldehyde test and the Chopra antimony test (Napier, 1937). Since these tests depend upon raised globulin levels, results can be positive in certain host's conditions (Bray, 1985). Lack of specificity as well as varying sensitivities renders these tests highly unreliable.

Several immunodiagnostic methods which are more sensitive and specific for VL have been developed over the years. They are useful in identifying specific cases and can be used for community surveillance. The consistent presence of

high levels of antibodies against parasite antigens can simplify diagnosis of VL. Several serological techniques are based on detection of these antibodies. The specificity of the antibody depends upon the antigen or epitope used in the test, as the parasite stimulates production of a wide array of antibodies, including group, genus and species-specific antibodies. Therefore, the sensitivity may depend upon the test and its methodology, but the specificity will depend on the antigen rather than the serological procedure used. In most serological tests, the sensitivity and specificity data are compared against demonstration of parasites in various tissues.

Conventional methods for antibody detection include gel diffusion, complement fixation test (CFT), indirect haemagglutination test, indirect immunofluorescent antibody (IFA) test and countercurrent immunoelectrophoresis (Bray, 1985; Muazzam *et al.*, 1992). However, aside from practical difficulties at peripheral laboratories, the sensitivities and specificities of most of the above tests have been the limiting factors. El-Harith and co-workers developed a direct agglutination test (DAT) for the detection of anti-leishmanial antibodies in serum samples from humans and dogs suspected for VL (Harith *et al.*, 1986). DAT is a relatively simple test with a high sensitivity and specificity noted in many studies carried out in Sudan (Harith *et al.*, 1988, Zijlstra *et al.*, 1992). In a meta-analysis of studies using DAT, the test had sensitivity and specificity of 94.8% (95% CI, 92.7%–96.4%) and 85.9% (95% CI, 72.3%–93.4%), respectively (Chappuis *et al.*, 2006). Although DAT showed a high degree of repeatability within the centres, its reproducibility across the centres was quite weak. Moreover, difficult field conditions, the fragility of aqueous antigen, the lack of cold chain and batch to batch variations in the antigen along with the nonstandardization of test readings have severely limited its widespread applicability in regions of endemicity. Besides, multiple pipetting, long incubation time, and high cost of antigen are all limiting factors for DAT (Schallig *et al.*, 2001). Like most antibody-based tests, DAT may yield positive results for a long time after complete cure and thus has not proved to be of much prognostic value (Harith *et al.*, 1988).

Enzyme linked immunosorbent assay (ELISA) has been used as a potential serodiagnostic tool for almost all infectious diseases including leishmaniasis. The technique is highly sensitive, but its specificity depends upon the antigen used. Several antigens have been tried. The commonly used antigen is a crude soluble antigen (CSA), prepared by repeated freezing and thawing of a suspension of promastigotes in phosphate-buffered saline, followed by cold centrifugation at 10,000 to 20,000 g. The supernatant is used as soluble antigen and is used to coat ELISA plates. The sensitivity of ELISA using CSA is reported to range from 80 to 100%, but cross-reactions with sera from patients with trypanosomiasis, tuberculosis and toxoplasmosis have been recorded (Singh *et al.*, 1995; Kumar *et al.*, 2001).

A kinesin-related protein-encoding gene has been discovered in *L. chagasi* that contains a repetitive 117 bp sequence encoding 39 amino acid residues (K39) conserved at the C-terminal end in all of the VL-causing isolates (Burns *et al.*, 1993). The recombinant product of K39 (rK39) has proven to be a very sensitive and specific antigen in an ELISA for the serodiagnosis of VL from the endemic foci in Bangladesh, Brazil, China, Pakistan and Sudan (Kurkjian *et al.*, 2005; Salam *et al.*, 2009). This recombinant antigen appears to be specific for antibodies in patients with VL caused by members of the *L. donovani* complex (Bern *et al.*, 2000). High antibody titres in immunocompetent patients with VL have been demonstrated and this antigen has been reported to be 100% sensitive and 100% specific in the diagnosis of VL and PKDL by ELISA (Singh *et al.*, 1995; Kumar *et al.*, 2001). Another important facet of anti-rK39 antibody is that the titre correlates directly with the disease activity, indicating its potential for use in predicting response to chemotherapy. The diagnostic and prognostic utility of rK39 for HIV-infected patients has also been demonstrated (Houghton *et al.*, 1998). Recently, the recombinant K28 antigen (rK28) has been introduced as a candidate for serological diagnosis of VL. In a micro-ELISA format it was compared with the rK39 ELISA and rK28 was found to be 99.6% sensitive (95% CI, 97%-99%), which was similar to sensitivity of rK39 ELISA. Specificity of the rK28 antigen in non-endemic healthy, endemic

healthy and different disease controls was 100% (95% CI, 96%-100%), 94.2% (95% CI, 88%- 97%) and 95.5% (95% CI, 84%-96%) respectively, which was similar to that of rK39 ELISA (Vaish *et al.*, 2012).

Because of the conditions prevailing in areas of VL endemicity, any sophisticated method cannot be employed on a wider scale. There is always a need for a simple, rapid and accurate test with good sensitivity and specificity, which can be used without any specific expertise.

A ready-to-use immunochromatographic strip test (ICT) based on rK39 antigen has been developed by InBios, International Inc. Seattle, WA and was approved by FDA as a rapid test for use in difficult field conditions. The recombinant antigen is immobilized on a small rectangular piece of nitrocellulose membrane in a band form and goat anti-protein A is attached to the membrane above the antigen band. Half a drop of blood or serum is smeared at the tip of the strip and the lower end of the strip is allowed to soak in a 2 to 3 drops of phosphate-buffered saline placed in a test tube. If the antibody is present, it will react with the conjugate (protein A colloidal gold) that is pre-dried on the assay strip. The mixture moves along the strip by capillary action and reacts with rK39 antigen on the strip, yielding a red band. Two red lines appear in the middle of the nitrocellulose membrane (the upper red band serves as a procedural control) for infected VL patients. In the first extensive field trial in India among 323 patients, the strip test was found to be 100% sensitive and 98% specific (Sundar *et al.*, 1998). In a few Bangladeshi studies, the sensitivity of rK39 strip test was ranged from 96.6% to 100%, while the specificity ranged from 86.95% to 98.3% (Sarker *et al.*, 2003b; Salam, 2008). Several studies from the Indian subcontinent reported the test to be 100% sensitive (Bern *et al.*, 2000; Sundar *et al.*, 2002b). However, when evaluated in Sudan, the sensitivity of the test was only 67%. In a study conducted in Sudan, all the parasitologically confirmed VL patients who tested negative by the rK39 strip test showed IgG at lower titres against rK39 antigen by micro-ELISA (Zijlstra *et al.*, 2001). In another study done in Southern

Europe, the rK39 strip test results were positive in only 71.4% of VL cases (Jelinek *et al.*, 1999). These differences in sensitivity may be due to differences in the antibody responses observed in different ethnic groups (Singh *et al.*, 1995). In a meta-analysis incorporating 13 studies for the evaluation of rK39 dipstick, combined sensitivity and specificity were 93.9% (95% CI, 87.7%–97.1%) and 95.3% (95% CI, 88.8%–98.1%) respectively (Chappuis *et al.*, 2006). As a whole the sensitivity seemed higher and more homogenous in South Asian studies and lower sensitivity was found in East African studies. For reasons that remain unclear, Sudanese patients seem to develop lower titres of antibodies against rK39 than do Indian patients (Boelaert *et al.*, 2008). When tested for PKDL, the test had 91% sensitivity (Salotra *et al.*, 2001). Although high levels of specificity (97% to 100%) have been reported for this test, however, with a later version of the rK39-treated strip, some (12.5%) healthy endemic control subjects also tested positive (Sundar *et al.*, 2002b). While such reactions might be considered to be false positive, but subclinical infections can not be ruled out for these cases.

In current scenario, rK39 ICT assay has been used as a reference standard for the diagnosis of VL in the Indian subcontinent but its inability to discriminate between clinical and subclinical infection in endemic population drew attention towards more specific and sensitive novel antigens. Many other *L. donovani* specific antigens like rK9, rK26, rKRP42 have been characterized that demonstrated variable specificity and sensitivity among endemic population (Maalej *et al.*, 2003). The sensitivity of rK26 antigen developed from *L. chagasi* was only 20–40% in India, while K9 yielded 78% sensitivity (Sundar *et al.*, 2007; Mohapatra *et al.*, 2010). As far as the diagnostic accuracy of these recombinant antigens is concerned, rK39 has been found as the leader worldwide (Chappuis *et al.*, 2006). A new generation fusion antigen, rK28 has been designed consisting of multiple tandem repeat sequences of the *L. donovani* HASPB1 and k39 kinesin genes to the complete open reading frame of HASPB2 increasing antigen epitope density which is claimed to perform better (Pattabhi *et al.*, 2010). rK28 dual platform pathway (K28-DPP) using a

distinct technology was developed by Chembio diagnostic systems (ChemBio Diagnostic System, Inc., Medford, NY) has been available but not yet commercialized. Sera from 73 parasitologically confirmed VL patients who were DAT or smear-positive and 62 negative sera (24 endemic controls, 20 malaria- and 18 tuberculosis-confirmed patients) with no history of VL were evaluated by rK28 and rK39 as a comparator in Sudan. The K28-DPP proved to be superior and provided a sensitivity of 95.9% and specificity of 100% against sensitivity of 86.3% and specificity of 96.4% by rK39 (Pattabhi *et al.*, 2010). But its diagnostic sensitivity and specificity in the Indian subcontinent are yet to be explored. Anti-rK39 IgG may be present in serum for an extended period after successful treatment for VL, thus patients with suspected relapse of VL with a past history of infection would not be candidates for diagnosis by strip testing. Another drawback of this format is that in a few cases a positive rK39 strip test result among patients suffering from illnesses like malaria, typhoid fever or tuberculosis with clinical features similar to those of VL yet is misdiagnosed. In conclusion, although it has got some limitations, the rK39 immunochromatographic strip test has proved to be versatile in predicting acute infection and it is the only available format for diagnosis of VL with acceptable sensitivity and specificity. Moreover, the test is inexpensive, simple and can be performed even by the paramedics in prevailing difficult field conditions.

2.11 HIV-Leishmania coinfection

Since the appearance of Human Immunodeficiency Virus (HIV), visceral leishmaniasis has emerged as an opportunistic infection in developed countries (Wolday *et al.*, 2001). The HIV/AIDS pandemic has modified the natural history of leishmaniasis. Both diseases exert a synergistic detrimental effect on the cellular immune response because they target similar immune cells. HIV infection increases the risk of developing VL in areas of endemicity, reduces the likelihood of a therapeutic response and greatly increases the probability of relapse. HIV-VL coinfection has been reported from more than 35 countries. Initially, most of these cases were from south-western Europe but the number

of cases is increasing in sub-Saharan Africa, Brazil and South Asia (Desjeux and Alvar, 2003). It appears in advanced stages of HIV infection and is supposed to accelerate the progression of AIDS (Alvar *et al.*, 2008).

Patients with leishmaniasis are highly susceptible to contract HIV and *Leishmania* accelerates the onset of AIDS by cumulative immunosuppression and stimulation of virus replication. Leishmaniasis is spreading in several areas of the world as a result of epidemiological changes which sharply increase the overlapping of AIDS and VL. Intravenous drug users have been identified as the main population at risk in southern European countries such as France, Italy, Portugal and particularly Spain (Rosenthal *et al.*, 2000). In these countries 20-70% of adult cases of VL are associated with HIV while up to 9% of those with AIDS also have VL. Diagnosis of VL in HIV co-infections are particularly difficult as the clinical signs are frequently absent and over 40% are seronegative. In reality VL/HIV patients have parasitemia and are highly infectious both to sandflies and, via needles and syringes, to other humans.

Atypical species and clinical presentations of VL in HIV-infected patients pose a considerable diagnostic challenge. The diagnostic principles remain essentially the same as those for non-HIV-infected patients. The presence of amastigotes may be demonstrated in buffy coat preparation. Sometimes the presence of amastigotes in unusual sites may be demonstrated e.g. amastigotes may be present in specimens from bronchoalveolar lavage, pleural fluid, or biopsy specimens from the gastrointestinal tract (Rosenthal *et al.*, 2000). For HIV patients, the sensitivity of antibody-based immunologic tests like the IFA test and ELISA is low (Albrecht, 1998). PCR analysis of the whole blood or its buffy coat preparation may prove a useful screening test for these patients, obviating the need for conventional traumatic procedures.

2.12 Genotyping of *Leishmania*

2.12.1 Background

Leishmaniases still constitute as major public health problems and the burden is increasing (Desjeux, 2001 & 2004). Approximately 0.2 to 0.4 million cases of VL and 0.7 to 1.2 million CL cases occur each year. Despite the huge amount of research conducted on pathogens causing leishmaniasis in numerous scientific fields since the beginning of the last century, there have been reactivation of several foci in Italy, China, Brazil and central Israel (Gradoni *et al.*, 2003; Guan *et al.*, 2003; Nasereddin *et al.*, 2005) and the emergence of new epidemic foci in northern and central Israel and Morocco (Al-Jawabreh *et al.*, 2004; Guernaoui *et al.*, 2005; Shani-Adir *et al.*, 2005). In addition, co-infection with *Leishmania* and human immunodeficiency virus becoming more and more problematic in developing and industrialized countries like Southern Europe (Wolday *et al.*, 2001; Desjeux, 2004). Nevertheless, these diseases are still considered as neglected diseases. For all these reasons, research on these parasites is necessary to improve diagnosis and epidemiological study in order to support drug and vaccine development.

The current classification of *Leishmania* is still based on isoenzyme typing by using multilocus enzyme electrophoresis (MLEE), as reviewed by Schönian *et al.* (2008). This approach has been the most widely used technique during the past 25 years for the identification of *Leishmania* at species and subspecific levels. However, MLEE has several limitations. Molecular studies have shown that differences in electrophoretic mobilities can be simply due to heterozygosity at a single nucleotide position (Jamjoom *et al.*, 2004) or are not a consequence of nucleotide diversity of the particular gene (Mauricio *et al.*, 2006; Zemanova *et al.*, 2007). On the other hand, indistinguishable zymodeme phenotypes have been shown to be produced by distinct genotypes (Mauricio *et al.*, 2006; Alam *et al.*, 2009a). Consequently, other molecular studies do not always agree with the classification of *Leishmania* parasites by MLEE. The discriminatory power of MLEE for classifications below species level is

limited because most of the *L. infantum* parasites causing visceral leishmaniasis in the Mediterranean and South America belong to the same zymodeme MON-1. Other important drawbacks of MLEE are that it requires bulk cultures of parasites, labour intensive, time-consuming and it can only be performed in specialized laboratories. Recently, changes in the epidemiology of the leishmaniasis have been reported from different endemic areas in the Old and New World. This includes amongst others, the emergence of new endemic foci (Karunaweera *et al.*, 2003; Sharma *et al.*, 2005): the spread of parasites to new areas (Capelli *et al.*, 2004; Nasereddin *et al.*, 2005); the sympatric presence of multiple species of *Leishmania* with overlapping clinical pictures (Al-Jawabreh *et al.*, 2004; Sharma *et al.*, 2005); the identification of new parasite-vector associations (Svobodova *et al.*, 2006a), indications of anthroponotic transmission of *L. infantum* (Svobodova *et al.*, 2009) and of zoonotic transmission for *L. tropica* (Svobodova *et al.*, 2006b); and the isolation of new as yet unclassified members of the genus *Leishmania* from CL cases (Villinski *et al.*, 2008). The re-emergence and spread of these diseases observed worldwide have been attributed to 3 main risk factors: (i) environmental changes of human origin, (ii) immunosuppression, and (iii) treatment failure and drug resistance (Dujardin, 2006). A sound and consensual taxonomical background based on the knowledge of the population structure and phylogenetic diversity is needed for a better understanding of these epidemiological changes (Bañuls *et al.*, 1999). For this, reliable, reproducible and user-friendly tools are required that allow differentiation of *Leishmania* parasites at species and strain levels.

2.12.2 Molecular epidemiology and markers for leishmaniasis

Molecular epidemiology is the application of molecular tools to answer epidemiological questions, particularly for pathogens. Molecular data are mainly analyzed in 2 different ways, by population genetics or phylogenetics. Population genetic analyses provide a snapshot of the current structure of genetic variation within and between populations whereas phylogenetic

analyses present information on the history of populations or organisms in the form of trees or networks. Most published studies are based on empirical analyses and, unfortunately, population genetic or phylogenetic approaches to data analysis have as yet been rarely used. This is perhaps due to the fact that the analytical methods and most available software are not very user-friendly and/or not well-suited for thorough analyses of the large datasets produced by molecular epidemiological studies (Constantine, 2003; Tibayrenc, 2005). Since the advent of PCR numerous molecular tools have been published that distinguish species and strains of *Leishmania* parasites. The tools range from the amplification and subsequent restriction fragment length polymorphism (RFLP) or DNA sequence analysis of multicopy targets or multigene families, including coding and non-coding regions and PCR-fingerprinting techniques, to the recently developed multilocus sequence typing (MLST) and multilocus microsatellite typing (MLMT) (Schönian *et al.*, 2008). Each of these molecular markers has its specific discriminatory power, advantages and drawbacks. This is especially important for the choice of the appropriate level of resolution. If the marker detects too much variation it may not faithfully represent more distant relationships and will fail to identify useful traits. If it is only moderately variable it will not explore the differences between closely related samples. Population genetic and phylogenetic approaches depend on neutral markers that are not affected by natural selection, although, in some situations non-neutral markers may identify a useful trait, e.g. virulence or drug resistance. Thus, markers should always be tested for neutrality. The markers should remain stable during in vitro or in vivo passage of the pathogens. The typing results should be reproducible, comparable between different laboratories and storable in databases. It should be possible to test intrinsic assumptions by comparing results from different methods of analyses and/or by examining the robustness of results using resampling techniques. The use of molecular markers directly in host tissues may be preferred because culture of *Leishmania* parasites often fails and may select for particular genotypes. Furthermore, direct methods facilitate sampling, although culture allows

isolation of biological clones. Last but not least, since molecular epidemiological studies normally involve large sample sets, methods that are cost-effective and allow for high-throughput analyses are desirable. In clonal organisms, there is a correlation between the number of markers needed and the sample size to be investigated. Increasing the number of samples and loci will improve the estimates of genetic distance. However, if enough appropriate loci are available, reliable estimates of genetic distances can be obtained from few individuals (Kalinowski, 2005). In contrast, in recombining organisms larger sets of independent markers are needed to detect intraspecific variation since each locus might have a separate evolution. In clonal populations the number of different genotypes seems to increase linearly with an increase in the number of markers, whereas a plateau will be reached for recombining organisms, after which no more genotypes are uncovered even if more loci are added (Halkett *et al.*, 2005). Genetic exchange has recently been demonstrated in insect stages of *Leishmania*, but it seems to be sporadic in natural populations (Akopyants *et al.*, 2009), although rates may vary between populations.

2.12.3 *Molecular markers for Leishmania at species level*

The epidemiologic studies as well as the usage of reference strains in laboratory experiments greatly depend on correct species identification. The genus *Leishmania* is divided into the two subgenera *Viannia* and *Leishmania* according to their development in the sandfly vector. Specification within the subgenera depends on several factors such as the geographical distribution of an isolate, the clinical presentation of the disease, and the epidemiology of the vector and the animal reservoir (Lainson and Shaw, 1987; Pearson *et al.*, 2001). This is especially useful for studies in areas with various co-existing *Leishmania* species. In addition, due to increasing international travel and population migration *Leishmania* parasites are imported into other regions of the world, including areas non-endemic for the disease (Harms *et al.*, 2003; Johnston *et al.*, 2009). The advantage of molecular approaches based on PCR

or other amplification techniques is that they combine high sensitivity for direct detection of the infecting parasites in various human, animal and sand fly tissues, with species specificity. Numerous PCR approaches have been published based on different coding and non-coding regions in the *Leishmania* genome. PCR assays amplifying the conserved region of kinetoplast minicircle DNA or SSU rDNA have been shown to be most sensitive, but can identify leishmanial parasites only to the generic and/or subgeneric level (Lachaud *et al.*, 2002; Disch *et al.*, 2005; Bensoussan *et al.*, 2006). On the other hand, amplification of species-specific DNA sequences (Salotra *et al.*, 2001; Laurent *et al.*, 2009) has serious limitations if not combined with a genus-specific assay to rule out false negatives and co-infections with other *Leishmania* species or inter specific hybrid infections. Approaches based on initial amplification of genus-specific sequences followed by subsequent differentiation of *Leishmania* species by RFLP, hybridization with specific probes or sequencing of the amplified sequences have proven most useful. Different targets have been used for this, such as the ribosomal internal transcribed spacer (ITS) (Schönian *et al.*, 2003; Nasereddin *et al.*, 2008); the mini-exon gene (Saki *et al.*, 2010) the glucose-6-phosphate dehydrogenase gene (Castilho *et al.*, 2003); gp63 genes (Mauricio *et al.*, 2007); hsp70 genes (Garcia *et al.*, 2004; Fraga *et al.*, 2010); cytochrome b gene (Kato *et al.*, 2005) etc.

Few research groups have tried to standardize and validate their PCR assay by testing for sensitivity and specificity not only with DNA extracted from cultured promastigotes but also with DNA extracted from different types of clinical material and from tissue samples spiked with known numbers of parasites, or by controlling for inhibition and the quality of DNA extraction, or by comparing their assays to other PCR assays (Schönian *et al.*, 2003; Bensoussan *et al.*, 2006; Nasereddin *et al.*, 2008). To date, the PCR-RFLP of the internal transcribed spacer 1 (ITS1) is the most widely used assay for direct detection and identification of *Leishmania* species in the Old World. By digesting the ITS1 PCR product with only 1 restriction enzyme, HaeIII, all medically relevant *Leishmania* species can be distinguished. Representatives of

the *L. donovani* complex or *L. braziliensis* complex have almost identical RFLP patterns with a great variety of restriction enzymes and cannot be resolved further by this approach (Schönian *et al.*, 2003). This problem can, however be solved by sequencing the 350bp ITS1 PCR product which, in the case of the *L. donovani* complex, not only allows for clear separation of *L. infantum* from *L. donovani*, but also assigns strains of these species to different phylogenetic groups supported by differences in biology and clinical behaviour (Kuhls *et al.*, 2005). A recently developed simple reverse line blot hybridization (RLB) assay based on ITS1 sequences seems to be very promising for leishmaniasis diagnostics because it distinguishes all Old World *Leishmania* species, even *L. donovani* from *L. infantum*, with a 10 to 100-fold enhanced sensitivity, comparable to that of kDNA PCR (Nasereddin *et al.*, 2008). More recently, high-resolution melt (HRM) analysis of a real-time PCR product from the ITS1 region was used to identify and quantify Old World *Leishmania* species (Talmi-Frank *et al.*, 2010). PCR assays combining detection of *Leishmania* parasites with species identification directly with clinical samples have proven useful in numerous field studies and should replace the current gold standard, multilocus enzyme electrophoresis. Species identification by PCR followed by RFLP, hybridization or sequencing is clearly less laborious and less costly than that by MLEE. However, the results of PCR diagnosis should always be evaluated in conjunction with clinical diagnosis, as PCR has been shown to be sensitive enough to detect parasite DNA in apparently parasitologically negative people living in areas endemic for leishmaniasis. A positive PCR result is thus a marker for infection or recent exposure rather than for disease (Deborggraeve *et al.*, 2008). Assays using alternative amplification technologies such as quantitative nucleic acid sequence-based amplification (QT-NASBA) based on amplification of 18S RNA and loop-mediated isothermal amplification (LAMP) of kinetoplast minicircle DNA do not allow discrimination of different *Leishmania* species (Van der Meide *et al.*, 2005; Takagi *et al.*, 2009). Commercialized assays that have been developed for direct detection of *Leishmania* are not able to identify

the infecting species. These commercial tests still rely on PCR for the amplification of the target and detection is achieved by hybridization to a genus specific probe covalently linked to a dipstick (Deborggraeve *et al.*, 2008b). Thus, for *Leishmania* species identification, in house PCR assays are still dependable option.

2.12.4 Molecular markers for *Leishmania* at strain level

Different DNA-based techniques have been used to differentiate *Leishmania* parasites at the strain level. These include DNA and PCR fingerprinting approaches, e.g. Randomly Amplified Polymorphic DNA (RAPD) techniques, which require cultured parasites because probes and primers used in this context are not specific for *Leishmania*. PCR fingerprinting and RAPD techniques have been successfully applied to characterize *L. tropica* strains in a new Israeli focus as well as to detect intraspecies variation in the *L. donovani* complex (Hide *et al.*, 2001; Zemanova *et al.*, 2004). These techniques are relatively simple, rapid and do not need prior sequence information, but suffer from poor reproducibility. Importantly, the results are not comparable between laboratories. Numerous epidemiological studies in leishmaniasis have used PCR-RFLP approaches based on sequence polymorphisms in coding and non-coding regions of multigene families, including cysteine protease B (cpB) (Quispe-Tintaya *et al.*, 2005); major surface glycoprotein (gp63) (Mauricio *et al.*, 2007); miniexon sequences (Mauricio *et al.*, 2004), and kinetoplast minicircles (Morales *et al.*, 2001; Cortes *et al.*, 2006; Laurent *et al.*, 2007). These approaches are relatively simple and rapid, and can be used directly with clinical isolates. The PCR-RFLP of whole minicircle DNA is a highly polymorphic assay that can differentiate between closely related organisms, such as *L. infantum* MON-1, and has been used to distinguish between recrudescence and re-infection (Morales *et al.*, 2002). All the strain specific DNA markers mentioned so far have one disadvantage in common, they are not co-dominant. The only co-dominant markers that currently differentiate within the *Leishmania* species and can detect all 3 diploid allele combinations possible

in a diploid are MLEE, multilocus sequence typing (MLST) and multilocus microsatellite typing (MLMT).

2.12.5 Targets for *Leishmania* genotyping and DNA sequencing

Internal transcribed spacer (ITS) sequence

A fascinating feature of biological life is the common use of the DNA genetic code and its subsequent processing into functional units of protein through the intermediate RNA molecule. The transcription and translation process are both highly regulated and compartmentalized in all living organisms. As the essential functions of ribosomes are critical for survival, their physical parameters have been conserved in all forms of life, from bacteria to humans. Some components within the ribosomal factories have, however, changed during the evolutionary process. These similarities, as well as the changes within genetic material can be used as tools for the identification of microorganisms including protozoa. The sequence homology within the rDNA genes of protozoa (18S, 5.8S and 28S genes) and differences within the spacer regions (ITS1 and ITS2) are the genetic basis for the organization of the protozoa into taxonomic groups (Iwen *et al.*, 2002).

Internal transcribed spacer refers to a piece of non-functional RNA situated between structural ribosomal RNAs (rRNA) on a common precursor transcript. This polycistronic rRNA precursor transcript contains the 5' external transcribed sequence (5' ETS), 18S rRNA, ITS1, 5.8S rRNA, ITS2, 28S rRNA and finally the 3' ETS (Fig. 2.6). During rRNA maturation, ETS and ITS pieces are excised and rapidly degraded. Genes encoding ribosomal RNA and spacers occur in tandem repeats that are thousands of copies long, each separated by regions of non-transcribed DNA termed *intergenic spacer* (IGS) or *non-transcribed spacer* (NTS). As DNA of ITS regions is removed and it is not part of the mature RNA molecule, they are considered non-coding regions of the genome. However, they are not normally identified as introns, but as intervening non-coding sequences or pseudo-introns because of their

importance as precursors in protein manufacturing. Sequence comparison of the ITS region is widely used in taxonomy and molecular phylogeny because (a) it is easy to amplify (due to the high copy number of rRNA genes) even from small quantities of DNA, and (b) has a high degree of variation even between closely related species (Mauricio *et al.*, 2004; Kuhls *et al.*, 2005).

ITS has been proven especially useful for elucidating relationships among congeneric species and closely related genera in clinically important yeast species (Chen *et al.*, 2001). The ITS region is now perhaps the most widely sequenced DNA region in fungi (Peay *et al.*, 2008). It has typically been most useful for molecular systematics at the species level, and even within species. Because of its higher degree of variation than other genic regions of rDNA (for small and large-subunit rRNA), variation among individual rDNA repeats can sometimes be observed within both the ITS and IGS regions.

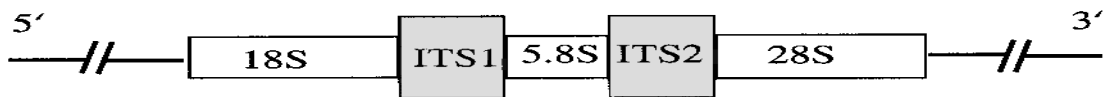

Fig. 2.6 Representation of the rDNA gene complex denoting gene order and position of the ITS regions.

Mini-exon sequences

The mini-exon or spliced leader (SL) gene found in all kinetoplastida as target sequence for a genotyping assay. The mini-exon gene, which is involved in the trans-splicing process in kinetoplastid protozoa is present 100 to 200 times per nuclear genome as tandemly repeated copies (Fig. 2.7), and it is absent from the vertebrate host or invertebrate vector. A detailed study on sequence variation in the mini-exon gene repeat of human pathogenic *Leishmania* species had previously shown that the diversity detected in the non-transcribed spacers represents an informative phylogenetic marker (Saki *et al.*, 2010). These features, together with a species-specific diversity designate the mini-exon for being exploited as a genotyping marker.

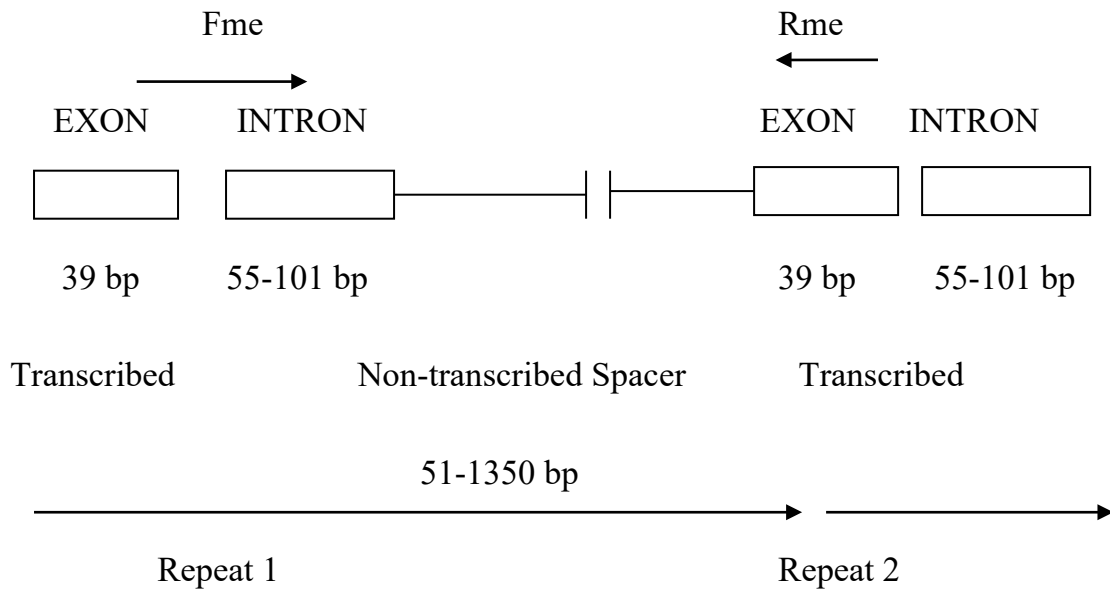

Fig. 2.7 The Mini-exon repeat of *Leishmania*. Each repeat contains a highly conserved exon (39bp), a moderately variable transcribed intron region (55 to 101bp), and a highly variable non-transcribed spacer sequence (51 to 1350bp) (Ramos *et al.*, 1996).

2.13 VL elimination programme in Bangladesh

Bangladesh, India and Nepal harbour an estimated 67% of the global VL disease burden, and the governments of these countries have launched a regional VL elimination programme (Alvar *et al.*, 2012). VL in the Indian sub-continent has some unique epidemiological, etiological and host response to treatment features. These are: VL is affecting the bordering districts of Nepal, India and Bangladesh; VL is caused only by the *L. donovani* parasite; *P. argentipes* is the only vector of the disease; high treatment response to anti-leishmanial drugs such as Miltefosine, Liposomal amphotericin B (AmBisome), Paromomycin and Amphotericin B Deoxycholate; and VL can be diagnosed with rK39 based rapid test in the field level. These features of VL in the Indian sub-continent inspired the policymaker from Bangladesh, India and Nepal to initiate a National VL Elimination Program and a Memorandum of Understanding was signed by the Government of these three countries in 2005 to eliminate VL by 2015. The elimination target is to reduce VL burden

less than 1 per 10,000 people at district level in Nepal and at sub-district (upazila) level in India and Bangladesh. The strategic objectives of the elimination program are: Early diagnosis and complete case management; Integrated vector management (IVM) and vector surveillance; Effective disease surveillance through passive and active case detection and vector surveillance; Social mobilization and building partnerships; and Clinical and operational research (WHO, 2004)

Bangladesh has started the elimination program in 2008 with the introduction of rapid diagnostic test (RDT rK39) for diagnosis and oral drug Miltefosine for management of VL. The diagnosis for VL and PKDL were scaled up to all the endemic sub-district (upazilla) level. The program already has initiated camp approach for early detection of cases with VL and PKDL twice early during the start of indoor residual spraying (IRS) for VL vector control. Field activities of organization such as ICDDR,B and MSF, Holland also have contributed in early detection of cases with VL and PKDL and complete treatment of VL patients with the most effective drug AmBisome by MSF in the most VL endemic sub-district (perhaps in the world) Fulbaria. The program has established a kala-azar research centre at the SK Hospital, Mymensingh in collaboration with JICA, Japan, DNDi and ICDDR,B.

The challenge for the program is how to keep early case detection and complete treatment through continuous training program of public health staff in the VL endemic sub-district hospitals, uninterrupted supply of diagnostics, drugs (Miltefosine) and introduction of single dose treatment with AmBisome, as a first line drug for VL in collaboration with the World Health Organization. Another challenge is that since the VL burden and case fatality rates are decreasing there is a chance for VL to get less priority by the policy makers. This may result in funding constraints for human resources and logistics for case management. Thus to keep the program activities alive beyond achieving the target of the elimination, advocacy for the program by the national and international policymakers is highly desired. The PKDL burden is highest in

Bangladesh among the three countries of the elimination program. PKDL patients are threat for the success of the elimination program since these patients are clinically healthy, do not seek medical care, harbor the parasite over the years and can initiate new outbreak of VL in the community.

In conclusion, the national VL elimination program has been enjoying a steady success as a result of its huge activities in early case detection, complete treatment, IVM and clinical and operational research. However, the program needs to strengthen its activities for effective disease and vector surveillance, behavior communication change (BCC), monitoring and evaluation. The main constraints for the program are insufficient human resources, funds and logistics. Current constraints may be overcome through building partnership at national and international levels to make the program sustainable.

Chapter 3

MATERIALS AND METHODS

3.1 Ethical statement

The protocol of this study was approved by the ‘Ethical Review Committee’ of Rajshahi Medical College and by the “Institutional Animal, Medical Ethics, Biosafety and Biosecurity Committee” (IAMEBBC) of the Institute of Biological Sciences, University of Rajshahi, Bangladesh for ethical issues related to this research. Informed written consent (Appendix 13, 14, 15, and 16) was obtained from all adults (18 years and above) study participants at enrollment. For participants between 7 to <18 years, assent was obtained from them after taking permission from their parents or guardians; while for children below seven years of age, consent was obtained from their parents or guardians. Patients participated in this study upon giving voluntary informed written consent and no age or ethnic barrier were considered.

3.2 Sample size and study population

Two hundred participants (100 kala-azar patients and 100 controls) were included for the study following guidelines suggested by Boelaert *et al.* (2007). For feasibility of number of kala-azar patients, hospital records of Rajshahi Medical College Hospital (RMCH) for last few years were evaluated. It was observed that during one calendar year on and average seventy five (75) kala-azar patients are admitted for treatment in RMCH. The sources of patients are from Rajshahi and nearby districts (Chapai nawabgonj, Naogoan, Natore, Kushtia, Pabna, Sirajgonj, Joypurhat, Meherpur, Dinajpur etc.). These endemic

areas of greater Rajshahi cumulatively harbour about 20% of total kala-azar cases in Bangladesh. So, random selection of 100 kala-azar patients during the study period was feasible.

3.2.1 Study population

- (i) **Patients:** One hundred (100) parasitologically confirmed (spleen smear positive for *L. donovani* body) kala-azar patients of different age and sex admitted in RMCH were included for this study. These patients were randomly selected from 135 clinically suspected kala-azar patients, who underwent splenic aspiration and found smear positive for parasite.
- (ii) **Controls:** A total of 100 controls from following categories were included to calculate the specificities of diagnostic laboratory tests for kala-azar.
 - (a) *Endemic controls:* Thirty (30) apparently healthy individuals of both sex and different age living in the endemic areas of kala-azar without having current or past history of prolong fever, splenomegaly or other clinical features suggestive of visceral leishmaniasis were included as endemic controls.
 - (b) *Non-endemic controls:* Thirty (30) healthy individuals of both sex and different age living in the non-endemic areas of kala-azar without having current or past history of prolong fever, splenomegaly or other clinical features suggestive of visceral leishmaniasis were included as non-endemic controls.
 - (c) *Disease controls:* Forty (40) patients of different age and sex who had been suffering from diseases other than kala-azar with fever for ≥ 2 weeks and admitted in RMCH were included as disease controls.

3.2.2 Eligibility criteria for suspected kala-azar case

The clinical case definition of kala-azar as defined in the National Guideline and Training Module for Kala-azar elimination in Bangladesh (Rahman *et al.*, 2008) was followed. Kala-azar was suspected clinically when a patient presented with fever for more than 2 weeks hailing from an endemic area along with one or more of the following features, (a) splenomegaly (b) anaemia and (c) weight loss.

3.2.3 Inclusion criteria and clinical evaluation of kala-azar patient

Clinical suspect of kala-azar was made according to the National Guideline mentioned above to 135 patients who attended at the out patient department of RMCH. All 135 primary suspected kala-azar cases were admitted into different medical and paediatrics wards of the RMCH. After explanation of the purpose and procedure of the study, only patients who voluntarily consented through signing the informed written consent form were included for the study. Formatted structured questionnaire was used to record relevant general and medical history. Each patient was examined physically by trained doctor for the presence of splenomegaly, hepatomegaly and other relevant clinical signs. Body wasting was graded into mild and moderate grades by calculating body mass index (BMI) of the patient. Routine blood count was done to record different grades of anaemia (mild: Hb >9 g/dL, moderate: Hb 6-9 g/dL, severe: Hb <6 g/dL) evaluated through haemoglobin estimation by acid haematin method, total WBC count (normal $4-11 \times 10^9$ /L), platelet count (normal $150-400 \times 10^9$ /L) and ESR (mm in 1st hour, Weterngren method). Pancytopenia in KA patients was defined with hemoglobin level < 9 g/dL, WBC count < 4×10^9 /L, and platelet count < 100×10^9 /L. Bleeding time (BT, normal 1-5 min), Clotting time (CT, normal 5-11 min) and Prothrombin time (PT, normal 12-16 sec) were also estimated following standard laboratory methods. After routine laboratory evaluation, splenic aspiration was done for patients who consented voluntarily and did not have any contraindication for the invasive procedure. Then 100 confirmed kala-azar patients were consecutively included those who

had spleen smear positive for *L. donovani* amastigotes. All clinical findings and laboratory investigation results of study population were recorded into a predesigned data sheet and preserved confidentially.

3.2.4 Exclusion criteria of kala-azar patient

Clinically suspected kala-azar patients those who gave history of previous attack or treatment for kala-azar were excluded. Also patients who refused to participate or unfit for splenic aspiration were excluded.

3.3 Data management

Formatted structured questionnaire and laboratory result recording sheets were used as data collection tools in this study (Appendix 1a, 1b, 2a, 2b, 3a, 3b, 4a and 4b). Each of the questionnaires was scored for consistency and completeness. Then the cleaned data were coded and entered in to the computer with the assistance of MS Excel and SPSS program.

3.4 Study type and place

This was a descriptive and evaluation study for exploration of sensitivity, specificity and accuracy of diagnostic laboratory tests for kala-azar and experimental study for determining the genotype and genetic diversity of *Leishmania* detected from kala-azar patients.

Kala-azar patients and disease controls were enrolled from Rajshahi Medical College Hospital (RMCH). Healthy endemic and non-endemic controls were included from endemic and non-endemic areas of Rajshahi district. Laboratory works were performed at the Department of Microbiology of Rajshahi Medical College (RMC) and at the Parasitology Laboratory of International Centre for Diarrhoeal Disease Research, (ICDDR,B), Dhaka, Bangladesh. DNA sequencing was done at the Department of Parasitology, Institute of Tropical Medicine, Nagasaki University, Japan.

3.5 Study period

The study was carried out from July, 2010 to January, 2013.

3.6 Samples collection

Following proper aseptic precaution, splenic aspiration was done from hospitalized patients who fulfilled the pre-requisites for this invasive procedure and 3.0 ml of whole blood was collected from all patients and controls. In all settings where specimens were collected and prepared for testing, laboratory and health care personnel's followed current recommended sterile techniques including precautions regarding the use of needles and other sterile equipment as well as guidelines for the responsible disposal of all biological material and contaminated specimen collection supplies.

3.7 Laboratory Methods

3.7.1 Parasitological diagnosis

Splenic aspiration

Before splenic aspiration from admitted patients, all contraindications were excluded for each patient. Following proper aseptic precautions and standard techniques as described by Bryceson (1987), splenic aspiration was done by the trained doctor at bedside (Appendix-6). At least two good quality smears were prepared with the splenic aspirates on clean glass slides at bed side and was air-dried. The patient was closely monitored for at least 12 hours after the procedure for any possible complication.

Splenic smear microscopy

Splenic smears were stained by Leishman staining (Appendix-5) and was examined for visualization of intra or extra cellular amastigote form of LD body under oil-immersion objective of light microscope (Model CH20BIMF200, Olympus Optical Co., Ltd. JAPAN) in the Department of

Microbiology on the same day. Amastigotes in the smear were identified by seeing the typical morphology for amastigote (cytoplasm appeared pale blue, with a relatively large nucleus that stained red. In the same plane as the nucleus, but at a right angle to it, was a deep red or violet rod-like body called a kinetoplast) (Appendix-12). After identification, parasite density was scored microscopically by means of a logarithmic scale ranging from 0 (no parasite per 1000 oil immersion fields) to 6+ (>100 parasites per field) (Appendix-7) (Chulay and Bryceson, 1983).

Collection of blood

A single sample of 3.0 ml venous blood was collected into a vacuette K3 EDTA tube using disposable syringe and needle from each patient and control after disinfecting the selected venipuncture site with 70% alcohol by expert Medical Technologist. Buffy coat and plasma were separated for their further utilization.

Preparation and utilization of buffy coat

Buffy coat was separated following the principle of concentration gradient separation by using Histopaque solution (Histopaque-1119; Sigma-Aldrich). Three milliliters of collected blood was layered onto 3.0 ml of the Histopaque-1119 solution in a sterile 15 ml falcon tube. The tube was capped and then centrifuged in a tabletop centrifuge at 4,000 *g* for 10 minutes at ambient temperature. A diffuse gray band of leukocytes (buffy coat) in between the Histopaque solution and plasma above the erythrocyte pellet (Appendix-9) was aseptically removed with a fine tipped pipette and transferred into a sterile 1.5 ml microcentrifuge tube. Two smears were prepared on clean glass slides from buffy coat for microscopical demonstration of amastigote of LD body in Leishman-stained smear and remaining portion was preserved in microcentrifuge (eppendorf) tube for extraction of DNA to be utilized for various methods of PCR amplification.

Buffy coat smear microscopy

Leishman-stained buffy coat smears were examined under light microscope (Model CH20BIMF200, Olympus Optical Co., Ltd. JAPAN) using an oil immersion objective. Amastigotes of LD body in the smear were confirmed by demonstration of the standard parasite morphology using the following guidelines. (i) Amastigotes are usually seen extracellularly in the buffy coat smear under the oil immersion objective of a light microscope. (ii) The hallmark of identification of structures as amastigotes in the buffy coat smear is the typical conjugation of a nucleus and kinetoplast of unequal sizes. (iii) The typical morphology of amastigotes (oval or elliptical cells 2 to 4 μm in size, bounded by a cytoplasmic membrane containing the nucleus and kinetoplast, which are bound together at a right angle to each other and where the nucleus is larger than the kinetoplast) as demonstrated in splenic or bone marrow smears may not be well preserved in all amastigotes seen in the buffy coat smear. However, the distinct conjugation with variable size of nucleus and kinetoplast, which are covered by a complete or partially complete cytoplasmic rim, is characteristic of the presence of amastigotes and makes them sufficiently different from the platelets, which are the only structures that may be confused with them. Platelets usually remain as a cluster, and they are smaller than amastigotes. Moreover, there certainly is no separate nucleus and structure such as a kinetoplast inside the platelets. (iv) The number of amastigotes is low in a buffy coat smear in comparison to a splenic smear, which is logical. Therefore, careful and patient searching is always required for clear demonstration of amastigotes (Salam *et al.*, 2012).

3.7.2 Serological diagnosis

Utilization of plasma

After centrifugation, separated plasma was collected into a clean 1.5 ml microcentrifuge tube to perform serological tests by rapid Immuno-

chromatographic (ICT) test and Enzyme linked immunosorbent assay (ELISA) against recombinant K39 and K28 antigens.

Immunochromatographic test (ICT) for kala-azar

Principle of rK39: The *Kalazar Detect*[™] test for rK39 antigen (InBios International, Inc., Seattle, WA.) are qualitative, membrane based immunoassay for the detection of antibodies to visceral leishmaniasis in human serum. In ICT, the membrane is pre-coated with a novel recombinant VL antigen on the test line region and chicken anti-protein A on the control line region. During testing, the serum sample reacts with the dye conjugate (protein A-colloidal gold conjugate) which has been pre-coated in the test device. The mixture then migrates upward on the membrane chromatographically by capillary action to react with recombinant VL antigen on the membrane and generates a red line. Presence of this red line indicates a positive result, while its absence indicates a negative result. Regardless of the presence of antibody to VL antigen, as the mixture continues to migrate across the membrane to the immobilized chicken anti-protein A region, a red line at the control line region will always appear. The presence of this red line serves as verification for sufficient sample volume and proper flow and as a control for the reagents.

Principle of rK28-DPP: The Chembio immunoassay (Chembio Diagnostic System, Inc., Medford, NY) format is called the Dual Path Platform (DPP) that detects anti-leishmania antibody against rK28 antigen. It differs from conventional lateral-flow systems in that the test sample and the marker-detecting conjugate are delivered to the test line area independent of each other. The DPP assay has two laminated strips, connected to each other as a “T” shape inside a disposable plastic cassette. The first strip receives a sample and running buffer through the sample port. The sample migrates along the strip towards the second strip containing the test and control bands. Development of the assay is achieved by adding buffer to the development port. This step releases the conjugate (colloidal gold) and facilitates its migration to the test area. Antibodies, if present in the test sample, will bind to the capture reagent

immobilized on the second strip, and the conjugate will react with this complex, making the test band detectable by visual evaluation. Irrespective of the presence of antibodies in the test sample, the control band should develop to assure correct DPP assay performance.

Storage

The sealed pouch containing a single test strip was stored at room temperature (20-28⁰C) for the duration of its shelf life. The bottle containing Chase Buffer was also stored at room temperature as per manufacturer's instruction.

Test Procedure

- The test was performed soon after collection of plasma in most of the cases. Plasma was refrigerated at 2-8⁰C up to 3 days in cases when it could not be done on the same day of collection.
- Plasma was allowed to reach room temperature prior to testing.
- Test strip in case of *Kalazar Detect*TM and test device in case of Chembio DPP leishmania rapid test were removed from the foil pouches.
- 20 μ L of plasma was added to the test strip in the area beneath the arrow for *Kalazar Detect* and was then placed into a test tube so that the end of the strip was facing downward as indicated by the arrows on the strip, then 2-3 drops (150 μ L) of the Chase Buffer solution were added.
- For Chembio DPP leishmania rapid test, 5 μ L plasma with 2 drops of buffer were added into hole 1, then after 5 minutes 4 drops of buffer were added into hole 2.
- Results were read in 10 minutes for both RDTs.

Interpretation of Results

Positive Result

The test was considered positive when two red lines, one for the control and the other for the test appeared in their respective areas. Appearance of a faint line in the test area was also considered to interpret positive result (Appendix-10

and 11). A positive result indicates that the RDT detected anti-leishmanial antibodies.

Negative Result

The test was considered negative when only one red line appeared in the control area (Appendix-10 and 11). A negative result indicates that RDTs did not detect anti-leishmanial antibodies.

Procedural notes for rK39 ELISA

Preparation of coating plate for rK39 ELISA: 2.04 μL rK39 antigen was added to 5.998 ml of coating buffer. Aliquot was made by 50 μL of antigen and the plate was left for over night incubation (dilution was 25 ng rK39 antigen/ well in coating buffer). After over night incubation, the plate was washed 3 times with washing buffer (300 μL per well). Then 250 μL of 1% BSA was added to each well and incubated for 3 hours at room temperature. Finally the plate was washed 5 times and kept for long-term preservation (Appendix-8).

Sample preparation

The plasma sample was diluted 1: 100 by diluents (10 μL of plasma sample in 990 ml of diluents).

Assay procedure

- 50 μL of each of the sample, standard, control and blank were taken into well.
- Incubated at room temperature for 30 minutes.
- The plate was washed 5 times by washing solution.
- 50 μL of conjugate was added to each well.
- Incubated at room temperature for 30 minutes.
- Washed 6 times by washing solution.
- Incubated for 3 minutes at room temperature.
- 100 μL of Trimethyl Benzidine (TMB) substrate was added to each well.
- Incubated for 3 minutes at room temperature.
- 100 μL of 1 N Sulphuric acid was added to each well.

Within 20 minutes, the absorbance was read at 450 nm. The result was expressed as Optical Density (OD) value according to the absorbance.

Procedural notes for rK28 ELISA (Greiner bioone)

- ELISA plates (MICROLON, 96 W) were coated with 50 μ L (containing 25ng) of antigen
- Overnight incubation was done at 4°C
- Plates were washed 3 time with wash buffer (PBS containing 0.05% Tween 20)
- 250 μ L of blocking buffer (PBS containing 1% BSA) were added and incubated at 37°C for 3 hours
- Plates were washed 5 times with wash buffer
- 50 μ L of 1:100 diluted serum (diluted in serum dilution buffer: PBS-.01%-BSA-0.05% Tween 20) were added
- Incubated at 37°C for 1 hour
- Washed 5 times with wash buffer
- 100 μ L of HRP-conjugated Rabbit anti-human IgG (diluted at 1:4000 in serum dilution buffer) were added
- Incubated at 37°C for 1 hour
- Washed 5 times with wash buffer
- 100 μ L of Tetramethyl benzidine (TMB) were added
- Plates were placed in the dark for 5-10 minutes
- 100 μ L of stop solution (1N H₂SO₄) were added
- Reading was taken immediately on an ELISA reader at 450 nm.

3.7.3 Molecular diagnosis

Buffy coat DNA extraction for PCR

DNA was extracted from the buffy coat by using the QIAamp DNA Mini Kit (QIAGEN, Hilden, Germany). The following steps were performed:

- Frozen samples and all reagents were left on the bench till thawed (30 to 60 min).
- Buffer AW1 and buffer AW2 were prepared as described in the manufacturer's protocol elucidated below:
 - (a) 95 ml concentrated AW1 buffer was mixed with 125 ml of 96-100% ethanol to obtain 220 ml.
 - (b) 66 ml concentrated AW2 buffer was mixed with 160 ml of 96-100% ethanol to obtain 226 ml.
- 20 μ L protease (proteinase K) was placed into the bottom of a 1.5 ml microcentrifuge tube.
- 200 μ L samples were added to the microcentrifuge tube.
- 200 μ L AL buffer was added to the microcentrifuge tube and was mixed by vortexing for 15 seconds.
- Incubated at 56°C for 15 minutes in water bath.
- The microcentrifuge tube was briefly centrifuged to remove drops from inside of the lid.
- 200 μ L of ethanol (96 -100%) was added to the sample and mixed by pulse vortexing for 15 seconds and then briefly centrifuged.
- 620 μ L of the solution from the above step was applied to the QIAamp spin column (in a 2 ml collection tube) without wetting the rim. The cap was closed and centrifuged at 8000 rpm for 1 minute. The QIAamp spin column was placed in a new 2 ml collection tube and the tube containing the filtrate was discarded.
- The QIAamp spin column was opened carefully and the above step was repeated.

- The QIAamp spin column was opened and 500 μ L buffer AW1 was added. The cap was closed and centrifuged at 8000 rpm for 1 minute. The QIAamp spin column was placed in a new 2 ml collection tube and the tube containing the filtrate was discarded.
- The QIAamp spin column was opened and 500 μ L of buffer AW1 was added. The cap was closed and centrifuged at full speed (14000 rpm) for 3 minute.
- The QIAamp spin column was placed in a clean 1.5 ml microcentrifuge tube. The old collection tube containing the filtrate was discarded. The QIAamp spin column was opened and 200 μ L of AE buffer was added. The cap was closed and incubated at room temperature for 5 minutes. The tube was microcentrifuged at 8000 rpm for 1 minute.
- DNA thus obtained was stored at -20°C .

Leishmania nested polymerase chain reaction (Ln-PCR)

We used a previously reported Ln-PCR with primers targeting the parasite's small-subunit rRNA (*SSU*-rRNA) region (Cruz *et al.*, 2002). An advantage of this Ln-PCR is its high sensitivity and specificity due to the use of a second set of *Leishmania*-specific primers, designed to an internal sequence of the first PCR products. For the first PCR run, we used *Kinetoplastida*-specific primers R221 [5'-GGTTCCTTTCCTGATTTACG-3'] and R332 [5'-GGCCGGTAAAGGCCGAATAG-3'] (Table 3.1). In the first PCR, 2 μ L of extracted DNA (approximately 10-20 ng) was amplified in a final volume of 25 μ L using the commercially available kit from GE Healthcare (Cat # 27-9557-01) [Illustra Pure Taq] which contained 200 μ M each dNTP in 10mM tris-HCl, 50 mM KCl, 1.5 mM MgCl₂, 2.5units of pure Taq DNA polymerase, BSA and stabilizers for each reaction. A 0.3 μ mol/L concentration of each *Kinetoplastida*-specific primer (R221 and R332) and an additional 3.0 mM MgCl₂ were also added to each of the commercially available tube from GE Healthcare (Table 3.2).

Table 3.1 First set of primers for Ln-PCR

Primers	Oligonucleotide sequence (5'-3')	Concentration
R221	GGTTCCTTTCCTGATTTACG	0.3 $\mu\text{mol/L}$
R332	GGCCGGTAAAGGCCGAATAG	0.3 $\mu\text{mol/L}$

Table 3.2 PCR master mix for first amplification of Ln-PCR

PCR components	Volume (μL)
Deionized water (H_2O)	20.00
Forward primer, R221	0.50
Reverse primer, R332	0.50
MgCl_2	2.00
Template DNA	2.00

Amplification was performed on a Bio-Rad MyCycler. The cycling conditions were 94°C for 5 min followed by 35 cycles; of 94°C for 30 sec, 60°C for 30 sec, and extension at 72°C for 30 sec, followed by a final extension at 72°C for 5 min (Table 3.3).

Table 3.3 Protocol for first amplification of Ln-PCR

Steps	Temperature	Time	Cycle number
Step 1	94°C	5 min	1x
Step 2	94°C	30 sec	40x
	60°C	30 sec	
	72°C	30 sec	
Step 3	72°C	5 min	1x

Prior to the second amplification, or nested PCR, the amplified products from the first run were diluted at 1:20 with molecular-grade water (Promega), and 2 μL was added to a 25 μL reaction volume, as described above, containing 0.15 $\mu\text{mol/L}$ of the *Leishmania*-specific primers R223

[5'-TCCCATCGCAACCTCGGTT-3'] and 0.10 $\mu\text{mol/L}$ of R333 [5'-WUGCGGGCGCGGTGCTG-3'] (Table 3.4) and additional 2.0 mM MgCl_2 to each of the commercially available tube from GE Healthcare (Table 3.5). The nested round of amplification was performed at 94°C for 3 min followed by 35 cycles, each of which consisted of 94 °C for 30 sec, 65 °C for 30 sec, and 72 °C for 30 sec followed by a final extension at 72°C for 5 min, in a BioRad's MyCycler (Table 3.6). In both amplifications, initial Taq DNA polymerase activation was performed at 95°C for 3 min.

Table 3.4 Second set of primers for Ln-PCR

Primers	Oligonucleotide sequence (5'-3')	Concentration
R223	TCCCATCGCAACCTCGGTT	0.15 $\mu\text{mol/L}$
R333	WUGCGGGCGCGGTGCTG	0.10 $\mu\text{mol/L}$

Table 3.5 PCR master mix for second amplification of Ln-PCR

PCR components	Volume (μL)
Deionized water (H_2O)	20.25
Forward primer, R223	0.50
Reverse primer, R333	0.25
MgCl_2	2.00
Template DNA	2.00

Table 3.6 Protocol for second amplification of Ln-PCR

Steps	Temperature	Time	Cycle number
Step 1	94°C	5 min	1x
Step 2	94°C	30 sec	40x
	60°C	30 sec	
	72°C	30 sec	
Step 3	72°C	5 min	1x

Gel detection of Ln-PCR products

Amplification products were separated by electrophoresis on a 2% agarose gel with a 100 bp DNA ladder (Invitrogen, catalog no. 15628-019) as molecular size marker and stained with ethidium bromide (0.1mg/ml). Stained gels were visualized and photographed under UV light emission with a UV transilluminator (Bio-Rad, Milan, Italy, S.N. 75S/03589). Amplification products were visualized and positive samples yielded a PCR product of 358 bp (Fig. 4.17). In every run, molecular-grade water and healthy human DNA were used as negative controls and DNA from cultured promastigotes served as a positive control.

Loop Mediated Isothermal Amplification (LAMP)

Principle of LAMP

"LAMP" is characterized by the use of 4 different primers specifically designed to recognize 6 distinct regions on the target gene and the reaction process proceeds under an isothermal condition using strand displacement reaction. Amplification and detection of gene can be completed in a single step, by incubating the mixture of a target gene, primers, *Bst* DNA polymerase with strand displacement activity and substrates at a constant temperature of 60-65°C by using basic equipment such as a heat block or water bath. It provides high amplification efficiency, with DNA being amplified 10^9 - 10^{10} times in 15-60 minutes. Moreover, because LAMP reactions cause turbidity in the reaction mixture proportional to the amount of amplified DNA, identification of positive or negative results is easily to make visually.

DNA extraction for LAMP

Samples of buffy coat from both VL subjects and controls were used for DNA extraction. Total DNA was extracted from buffy coat as described by Motazedian *et al.* (2002) with minor modification. Briefly, 0.5 ml of buffy coat was centrifuged, and its pellet was homogenized with 200 μ L of lyses buffer

and 10 μL of a proteinase K solution in a 1.5 ml micro-centrifuge tube. The homogenate was then incubated at 37°C overnight before 200 μL of a phenol–chloroform–isoamyl alcohol mixture was added. After being shaken vigorously, the tube holding the mix was centrifuged ($10000 \times g$ for 10 min), and then the DNA in the supernatant solution was precipitated with 400 μL cold pure ethanol, re-suspended in 50 μL double-distilled water, and then stored at 4°C until it could be tested.

Procedure of LAMP

The LAMP reaction was carried out according to the original reports described by Notomi *et al.* (2000) and Nagamine *et al.* (2002). A set of four primers had already been designed specific for *L. donovani* kinetoplast minicircle DNA (GenBank accession no.Y11401) by Primer Explorer software (<http://primerexplorer.jp/>) for diagnosis of VL from blood DNA (Takagi, 2009). For the present study we used the same sets of primers and probe for VL diagnosis from buffy coat DNA. The locations of targeted sequences are shown in Figure 3.1.

The LAMP reaction was performed in 25 μL of reaction mixture containing 40 pmol each of FIP and BIP primers, 5 pmol each of F3 and B3c primers (Table 3.7) 1.4 mM of each deoxynucleoside triphosphate, 0.8 M betaine, 20 mM Tris-HCl, pH 8.8, 10 mM KCl, 10 mM $(\text{NH}_4)_2\text{SO}_4$, 8 mM MgSO_4 , 0.1% TritonX-100, 8 units of *Bst* DNA polymerase large Fragment (New England Biolabs, Ipswich, MA), and 2 μL of sample DNA (Table 3.8). Each tube containing the reaction mixture was sealed with paraffin as LAMP caused massive amplification which might result contamination of DNA and incubated in a heat block at 62°C for 1 hour and 30 minutes. As the LAMP reaction progressed, the reaction by-product (pyrophosphate ions) bounded to magnesium ions and formed a white precipitate of magnesium pyrophosphate, making the reaction fluid turbid. After incubation, the turbidity was inspected visually (Fig. 4.21A). For further confirmation, 3 μL of the LAMP products was subjected to electrophoresis with a 100 bp DNA ladder (BioLabs Inc., New

England, UK) on a 2% agarose gel and visualized under ultraviolet light after staining with ethidium bromide (Fig. 4.21B).

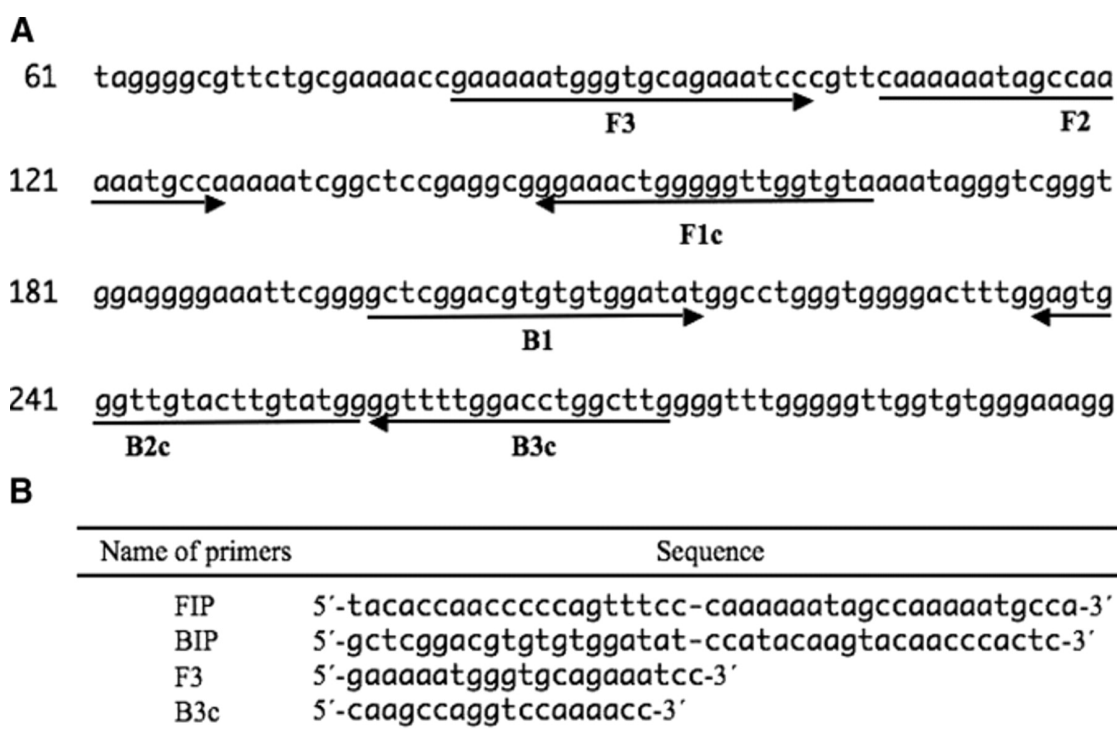

Fig. 3.1 Primers and their locations for amplification of *Leishmania donovani* kinetoplast minicircle DNA by LAMP. **A-** locations of the primer sequences. **B-** names and sequences of four primers. Primer FIP consists of F1 complementary sequence and F2 direct sequence. Primer BIP consists of B1 direct sequence and B2 complementary sequence.

Table 3.7 Primers for LAMP

Primers	Oligonucleotide sequence (5'-3')	Concentration
FIP	tacaccaacccccagtttcc-caaaaaatagccaaaaatgcca	40 pmol
BIP	gctcggacgtgtgtggatat-ccatacaagtacaaccactc	40 pmol
F3	gaaaaatgggtgcagaaatcc	5 pmol
B3c	caagccaggtccaaaacc	5 pmol

Table 3.8 PCR master mix for LAMP

PCR Components	Volume (μL)
10x New England Buffer	2.5
Primer Mix	0.9
dNTP	3.5
5M Betaine	4.0
10mM MgSO ₄	2.0
Bst DNA polymerase (Large Fragment)	1.0
H ₂ O	9.1
DNA	2.0

Mini-exon PCR

The PCR was performed according to Marfurt *et al.* (2003) with minor modifications. It included 0.5 μM of each of the forward primer, Fme (5'-TAT TGGTAT GCG AAA CTT CCG-3') and reverse primer, Rme (5'-ACA GAA ACT GAT ACT TAT ATA GCG-3') (Table 3.9). For each round of PCR, 2 μL of DNA was amplified in a final volume of 25 μL containing 10 x PCR buffer containing Tris-Cl, KCl, (NH₄)₂SO₄, 15 mM MgCl₂; at pH 8.7 (20°C), 0.2 mM dNTPs, (QIAGEN, Hilden, Germany), 12% DMSO (Sigma), 40 mM tetramethylammonium chloride (Sigma), an additional 2mM MgCl₂, and 1.5 U Taq polymerase (QIAGEN, Hilden, Germany) (Table 3.10). The PCR was performed in BioRad Thermal Cycler with 5 min at 95°C followed by 35 cycles of 30 sec at 94°C, 30 sec at 54°C and 45 sec at 72°C followed by a final extension of 6 min at 72°C (Table 3.11).

Table 3.9 Primers for Mini-exon PCR

Primers	Oligonucleotide sequence (5'-3')	Concentration
Fme	TATTGGTATGCGAAACTTCCG	0.5 μM
Rme	CACTCAGG TCTGTAAAC	0.5 μM

Table 3.10 PCR master mix for Mini-exon PCR

PCR components	Volume (μ L)
10 x PCR Buffer	2.50
2mM dNTP	3.00
DMSO	3.00
TMAC	2.00
MgCl ₂	1.00
BSA	0.25
Fme	0.25
Rme	0.25
Taq DNA polymerase	0.30
H ₂ O	10.45
DNA	2.00

Table 3.11 Protocol for Mini-exon PCR

Steps	Temperature	Time	Cycle number
Step 1	95°C	5 min	1x
Step 2	94°C	30 sec	40x
	54°C	30 sec	
	72°C	45 sec	
Step 3	72°C	6 min	1x

Detection of Mini-exon PCR products by gel electrophoresis

All the PCR products were visualized in 1.5 % agarose gel (Invitrogen) in a BioRad Gel Doc and amplification products ranging from 378 bp to 435 bp were observed from VL patient samples (Fig. 4.18).

ITS1 and ITS2 PCR

Methodology as described by El-Tai *et al.* (2001) was followed. The ITS1 and ITS2 were separately amplified with the primer pairs L5.8S [5'-TGATACCACTTATCGCACTT-3']/ LITSR [5'-AAGTGCGATAAGTGGTA-3'] (Table 3.12) and L5.8SR [5'-AGAGTGCATGTGTGTAT-3'] / LITSV [5'-ATACACACATGCACTCTC-3'] (Table 3.13) respectively.

Table 3.12 Primers for ITS1 PCR

Primers	Oligonucleotide sequence (5'-3')	Concentration
Forward, LITSR	AAGTGCGATAAGTGGTA	25 pmol
Reverse, L5.8S	TGATACCACTTATCGCACTT	25 pmol

Table 3.13 Primers for ITS2 PCR

Primers	Oligonucleotide sequence (5'-3')	Concentration
Forward, L5.8SR	AGAGTGCATGTGTGTAT	25 pmol
Reverse, LITSV	ATACACACATGCACTCTC	25 pmol

The PCR (both ITS1 and ITS2) was carried out in a final volume of 25 μ L. For each round of amplification, 2 μ L of DNA was added to a PCR mixture containing 12.5 μ L of Promega Mastermix (Catalog number M7505) containing 50 units/ml of Taq DNA polymerase in proprietary reaction buffer (pH 8.5), 400 μ M of each primer, 3.0 mM MgCl₂ and 25 pmol of each of the primer pairs (Table 3.14). The amplification was performed according to the following protocol: initial denaturation at 95°C for 5 minutes followed by 40 cycles' consisting of denaturation at 95°C for 20 sec, annealing at 53°C for 30 sec followed by an extension at 72°C for 1 minute. A final extension of 72°C for 5 minutes was performed after the completion of 40 cycles (Table 3.15).

Table 3.14 PCR master mix for ITS 1 and ITS2 PCR

PCR components	Volume (μ L)
Deionized water (H ₂ O)	10.00
Forward primer	0.25
Reverse primer	0.25
2x Mastermix (Promega)	12.50
Template DNA	2.00

Table 3.15 Protocol for ITS1 and ITS2 PCR

Steps	Temperature	Time	Cycle number
Step 1	95°C	2 min	1x
Step 2	95°C	20 sec	40x
	53°C	30 sec	
	72°C	1 min	
Step 3	72°C	5 min	1x

Detection of ITS1 and ITS2 PCR products by gel electrophoresis

Amplification products were separated by electrophoresis on 2% agarose gel with 100 bp DNA ‘ladder’ (Invitrogen, USA, Cat. No. 15628-019) as molecular size-marker, and stained with ethidium bromide (0.1 mg/ml). Stained gels were visualized and photographed under UV light emission with a UV transilluminator (BioRad, Milan, Italy, S.N. 75S/03589). Amplification products were visualized and positive samples yielded a PCR product of 320 bp for ITS1 (Fig. 4.19) and 740 bp for ITS2 (Fig. 4.20). In every run, molecular-grade water was used as negative control and DNA from cultured promastigotes served as positive control. The amplification products were preserved at 4°C for DNA sequencing and genetic diversity exploration.

3.8 Genotyping of Leishmania by ITS1-RFLP analysis

ITS1 PCR products of 10.0 µL were digested with 10U of *Hae*III restriction endonuclease (BioLabs Inc., New England, UK) for 2 hours at 37°C. The restriction fragments were subjected to 2% agarose gel (Invitrogen) electrophoresis for 2 hours and visualized under UV light. The band patterns were compared with reference strain of *L. donovani* and *L. tropica* (Fig. 4.26).

3.8 Genetic diversity analysis by DNA sequencing

3.9.1 Methodology

PCR-amplified samples were treated with ExoSAP (GE Healthcare) for digesting primers which would avoid the PCR for the sequencing. One microliter of PCR product was mixed with 2 μ L of BigDye terminator v1.1, 4 μ L of 5x sequencing buffer and 1 μ L of 3.3 μ M of sequencing primer in total of 20 μ L of reaction (Applied Biosystems, USA) adjusted with deionized distilled water (DDW). The sequencing PCR was conducted according to the manufacturer's protocol, denaturing at 96°C for 10 sec, annealing at 50°C for 5 sec, elongation at 60°C for 4 min for 25 cycles (Applied Biosystems, USA). The ITS1 region (320 bp) was sequenced using primers LITSR and L5.8S, and ITS2 (740 bp) using primers L5.8SR and LITSV. Excess fluorescence dye was removed by using DyeEx 2.0 spin column (QIAGEN, Hilden, Germany) prior to the loading of the samples to 3730 DNA analyzer. The sequences were analyzed by sequence scanner v1.0 program (Applied Biosystems, USA).

3.9.2 DNA sequencing data analysis

Sequences were aligned using the multiple alignment program CLUSTAL W and manually adjusted. Phylogenetic analysis was performed using maximum parsimony as implemented by the MEGA (Molecular Evolutionary Genetics Analysis) computer program, Version 5.05 (Tamura *et al.*, 2011). Robustness of the internal branches was tested by bootstrap analysis (Felsenstein, 1985) from 1000 bootstrap replications using the heuristic search option and retaining groups compatible with the 50% majority rule consensus tree. Calculation of base pair differences was carried out by a pair wise comparison of the strains from alignments. Variation (V) of the compared sequences was calculated as $V = nd/n$, where nd is the number of different base pairs and n is the total number of base pair positions compared (Saitou and Nei, 1987). Microsatellites were analyzed separately using the program MICROSAT (Minch *et al.*, 1995). Microsatellite genetic distances were calculated for the numbers of repeats

within a locus using the measure *DAS*, which is based on the proportion of shared alleles (Bowcock *et al.*, 1994) and calculates multilocus pair wise distance measurements as $1 - s/n$, where n is the number of loci compared and s is the total number of shared alleles at all loci. The neighbor joining tree of the distance matrix was constructed in MEGA, Version 5.05 (Tamura *et al.*, 2011).

3.10 Statistical analysis

Sensitivity, specificity and diagnostic accuracy (kappa value) were calculated using the online Clinical Calculator 1 (<http://www.vassarstats.net/clin1.html>). A kappa value of 1 represents perfect agreement. Laboratory data and clinical parameters were analyzed using the SPSS software (version 11.5) for Windows. Performances of different diagnostic tools in respect to gold standard (spleen smear) were compared by McNemar's test and correlations between tools were done by Spearman correlation. The kappa value of different tools against spleen smear was used to construct a receiver-operator characteristic (ROC) curve.

3.10.1 Factor analysis for evaluation of VL diagnostic tools

Index or rank of different VL diagnostic tools based on their inherent characteristics (diagnostic accuracy i.e. kappa value, cost, interpretation of test results, availability, user friendliness, test type and potential for field use) was taken for analysis of index scores. We used a straightforward categorization (such as 0=low, 1=high, 2= higher etc.) to construct indices. Factor analysis (FA) in SPSS was used to construct indices. Indicator variables were standardized (mean zero and variable one) and principal component method in FA was used to extract the factors. Regression methods were used to generate factor scores. Only first factor was considered and corresponding factor scores was used to construct the indices. High score represents high performance of the diagnostic tools, and vice versa.

Chapter 4

RESULTS

4. RESULTS

Sensitivity, specificity and accuracy of kala-azar diagnostic tools encompassing parasitological, serological and molecular PCR-based methods were evaluated for one hundred (100) parasitological confirmed (spleen smear positive for amastigotes of LD body) kala-azar patients and 100 controls (30 endemic healthy controls; 30 non-endemic healthy controls and 40 disease controls) in this study. Diagnostic algorithm was constructed based on the performances of tools and their availability at different health care facilities in our country. Genotyping of *Leishmania* was done by using ITS1 PCR-RFLP analysis and ITS1 & ITS2 PCR amplicons were sequenced to explore genetic polymorphism.

4.1 Demographic and clinical characteristics of kala-azar patients

The demographic and clinical profiles of 100 kala-azar patients are shown in Table 4.1. In gender distribution, male outnumbered the female with 68% were male and 32% were female and male to female ratio was 2.13:1 (Fig. 4.1). Age of patients ranged from 1 to 60 years with mean 20.66 ± 15.86 years (Fig. 4.2). Monthly income of patient or their guardian ranged from Tk. 2500 to 15000 with mean Tk. 4005 ± 2631.87 (Fig. 4.3). Duration of fever among patients ranged from 4 to 52 weeks with mean duration of 20.61 ± 12.52 weeks (Fig. 4.4). Ninety eight percent (98%) of KA patients had splenomegaly ranged from just palpable to up to 12 cm from costal margin along the left mid-clavicular line, while 76% had concomitant

palpable liver. Anaemia was noted among 99% of patients with frequency of mild, moderate and severe anaemia was 32%, 47% and 20% respectively (Fig. 4.5). Body wasting was categorized into mild and moderate with frequency of 75% and 25% respectively. Ninety six percent (96%) of patients had blackening of their skin while 100% had weight loss. As far as the family history and past history of kala-azar among patients are concerned, 18% had member(s) of their family affected and 13% had suffered from previous attack of kala-azar. As rare clinical presentations, 2% of patients presented with jaundice and 9% complained of bleeding manifestation during diagnosis. Pancytopenia as supportive laboratory evidence of KA was noted among 40% of patients.

Geographical distribution of kala-azar patients those who were enrolled in the present study are shown in Fig. 4.6. A total of 100 kala-azar patients were enrolled from 10 districts including Naogaon, Nawabgonj, Kushtia, Rajshahi, Pabna, Sirajgonj, Natore, Joypurhat, Meherpur and Dinajpur. District-wise number and gender distribution of kala-azar patients are shown in Fig. 4.7. Highest number of patient was from Naogaon district (21; M-18, F-3), followed by Chapai Nawabgonj (18; M-10, F-8), Kushtia (16; M-12, F-4), Rajshahi (15; M-12, F-3), Pabna (12; M-6, F-6), Sirajgonj (10; M-6, F-4), Natore (4; M-2, F-2), Joypurhat (2, F-2), Meherpur (1, M) and Dinajpur (1, M).

Erythrocyte Sedimentation Rate (ESR) becomes very high in kala-azar patients and it was recorded as one of the important laboratory findings. ESR of kala-azar patients ranged from 25 to 175 mm in 1st hour (Westergren method) and mean ESR was 101.90 ± 33.08 mm in 1st hour (Fig. 4.8).

Table 4.1 Demographic and clinical characteristics of kala-azar patients

Characteristics	Number (N)	Percentage (%)
Sex		
- Male	68	68.0
- Female	32	32.0
Mean age (Years)	20.66 ±15.86	
Monthly income (Tk.)	4005 ±2631.87	
Fever (weeks)	20.61 ±12.52	
Spleen		
- Palpable	98	98.0
- Not palpable	2	2.0
Liver		
- Palpable	76	76.0
- Not palpable	24	24.0
Anaemia		
- Nil	1	1.0
- Mild	32	32.0
- Moderate	47	47.0
- Severe	20	20.0
Wasting		
- Mild	75	75.0
- Moderate	25	25.0
Blackening		
- Yes	96	96.0
- No	4	4.0
Weight loss		
- Yes	100	100
- No	00	00
Family History of VL		
- Yes	18	18.0
- No	82	82.0
Past History of VL		
- Yes	13	13.0
- No	87	87.0
Jaundice		
- Yes	2	2.0
- No	98	98.0
Bleeding		
- Yes	9	9.0
- No	91	91.0
Pancytopenia		
- Yes	40	40.0
- No	60	60.0

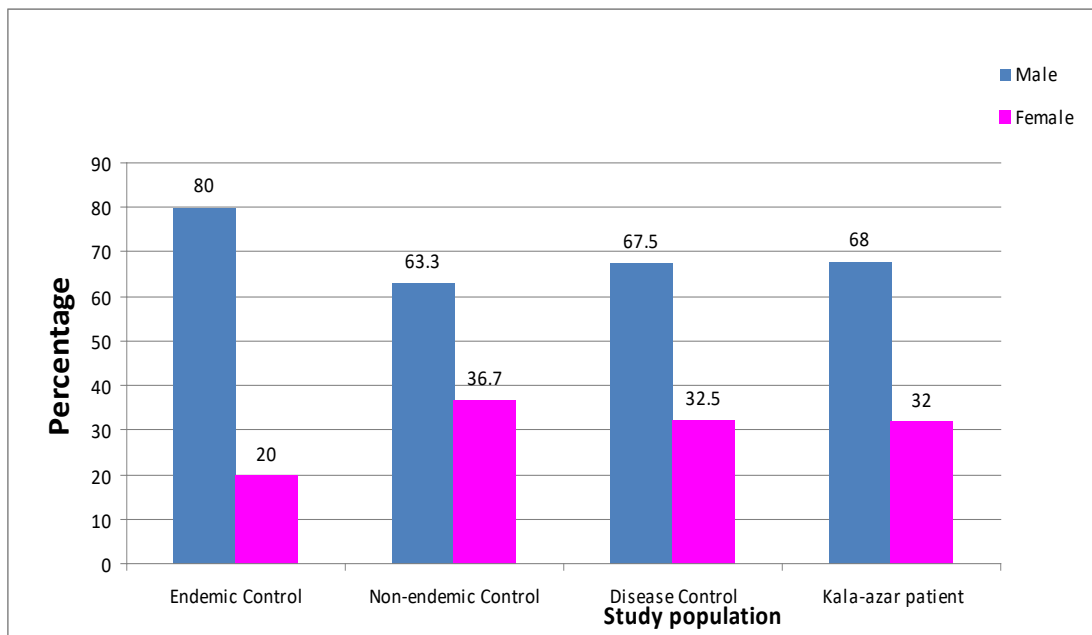

Fig. 4.1 Gender distribution of study population (patients and controls)

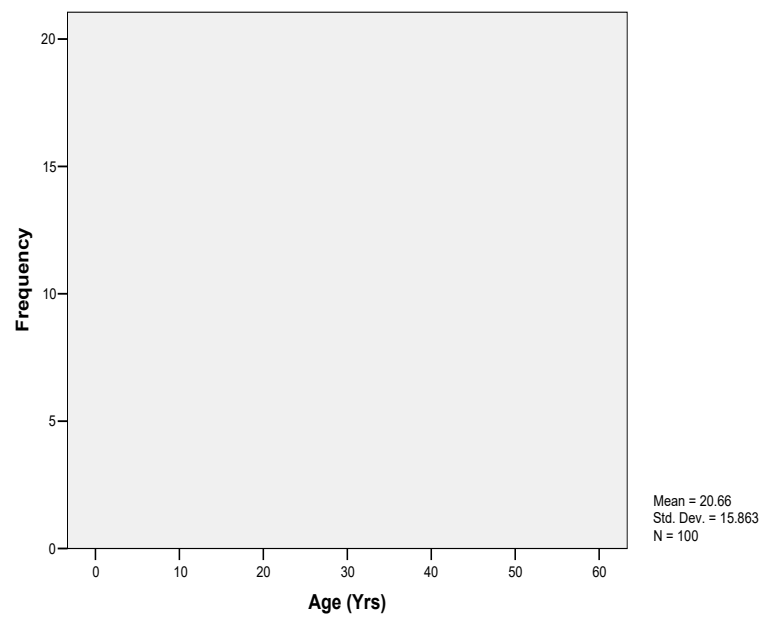

Fig. 4.2 Age distribution of kala-azar patients

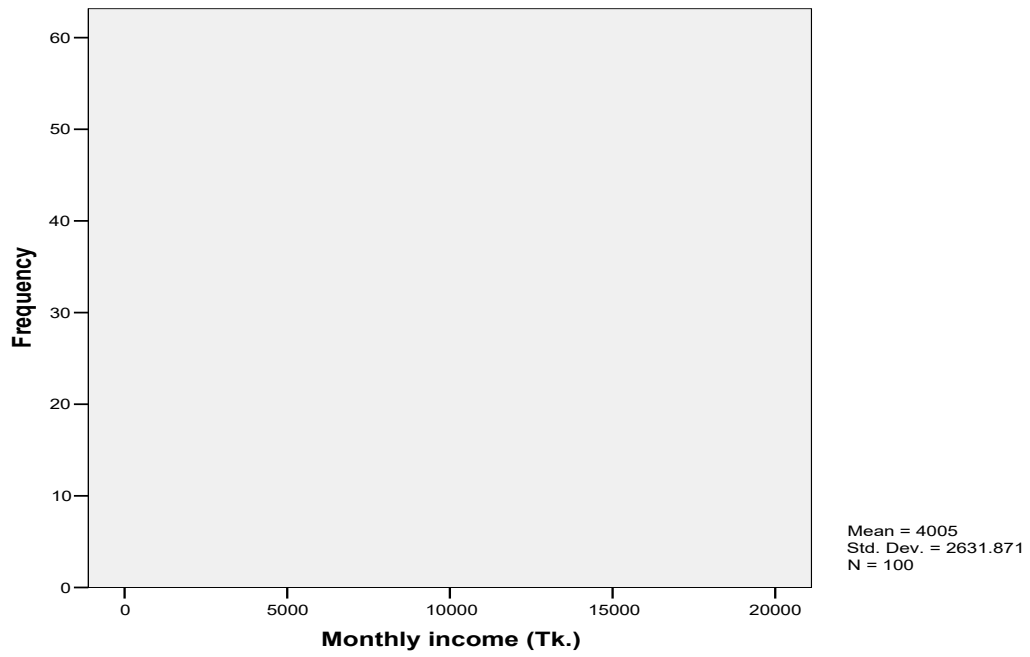

Fig. 4.3 Monthly income (Tk.) of kala-azar patients

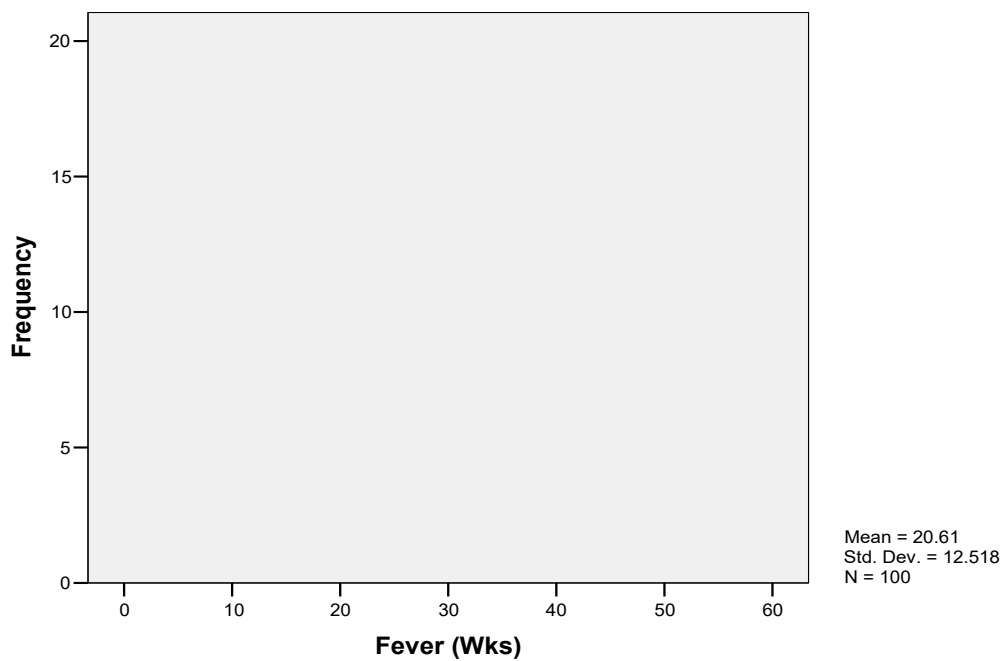

Fig. 4.4 Duration of fever (in weeks) among kala-azar patients

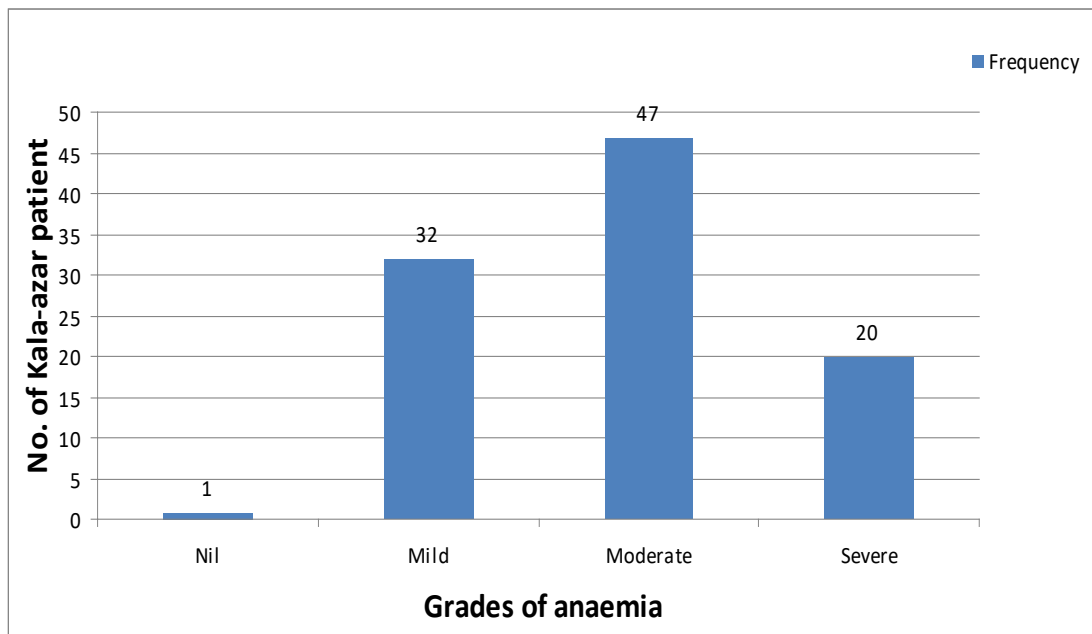

Fig. 4.5 Different grades of anaemia among kala-azar patients

District-wise distribution of kala-azar patients

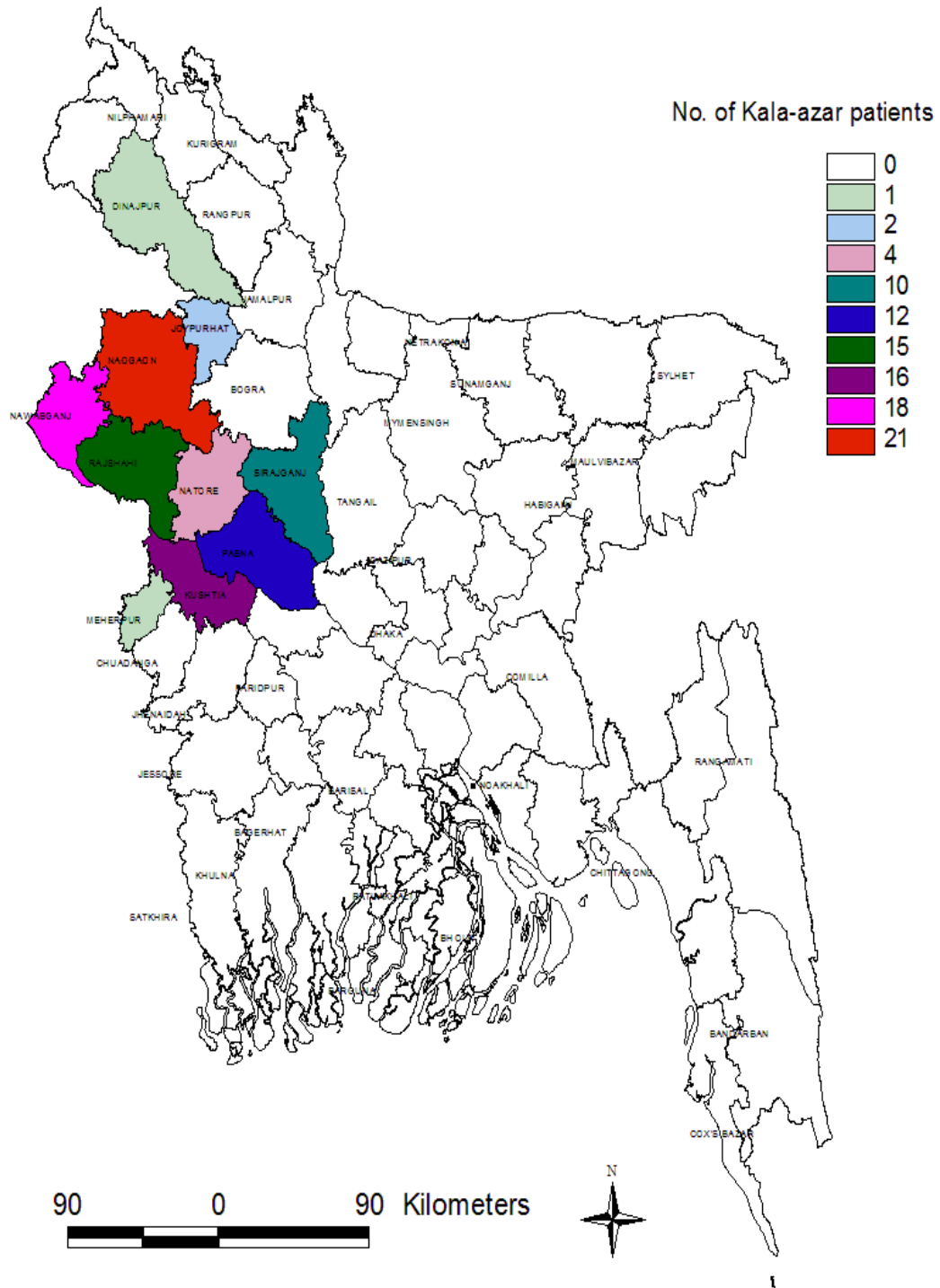

Fig. 4.6 Geographical distribution of kala-azar patients enrolled in the study

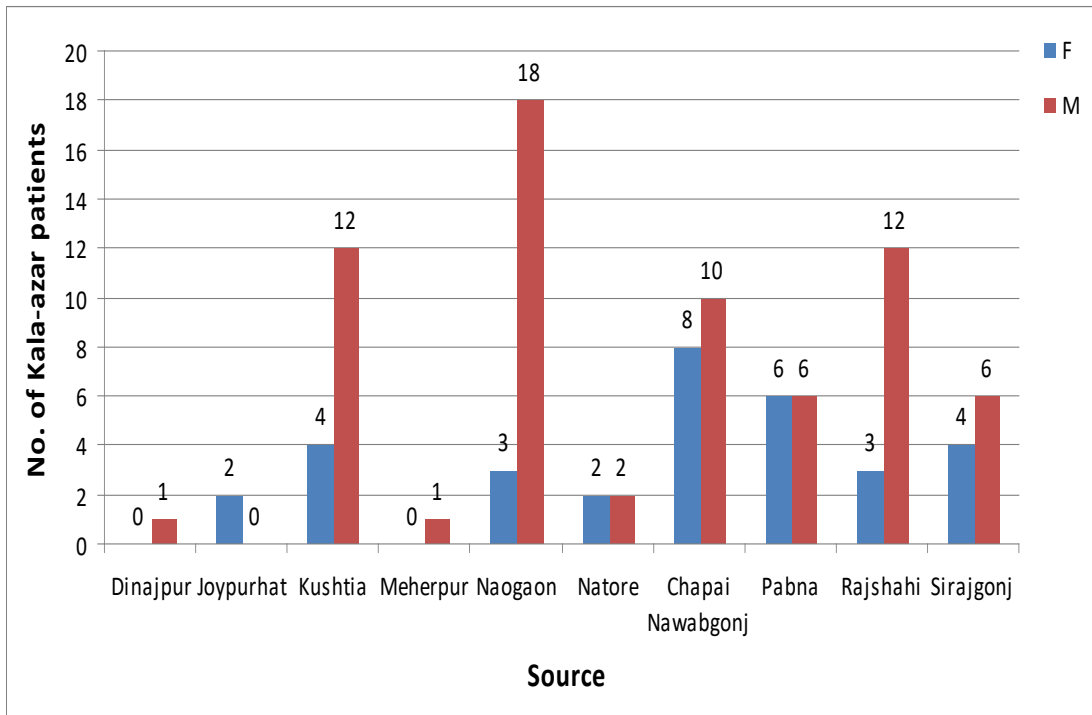

Fig. 4.7 District-wise number and gender distribution of kala-azar patients

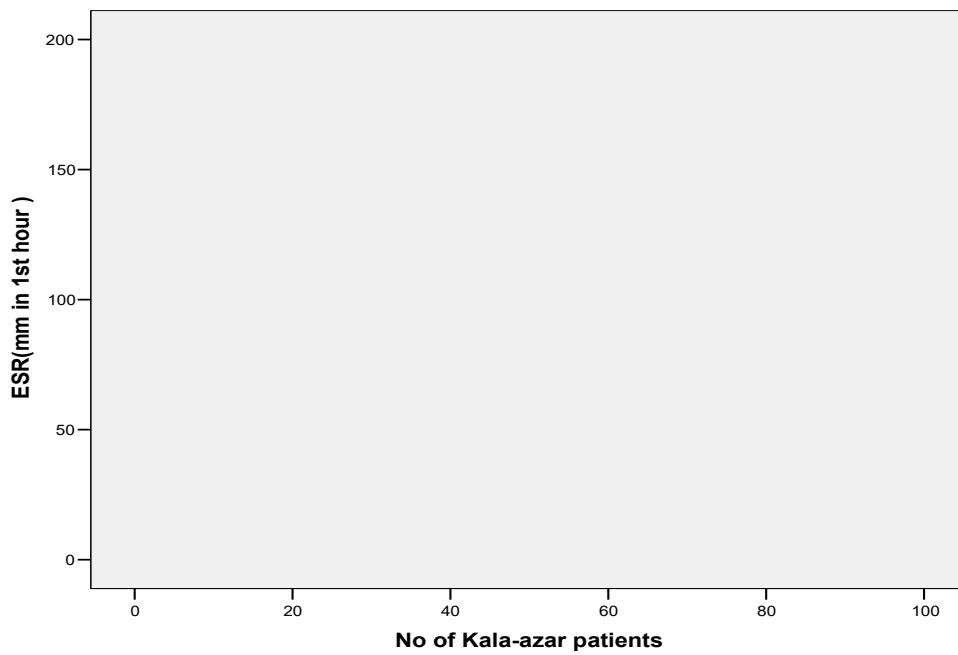

Fig. 4.8 Distribution of ESR of kala-azar patients

4.2 Demographic, clinical and laboratory findings of endemic and non-endemic controls

Demographic, clinical and laboratory findings of 30 endemic controls are shown in Table 4.2. Number of male was predominant over female with male to female ratio of 4:1 (Fig. 4.1). Mean age of endemic controls was 32.20 ± 9.02 years. Family history of kala-azar was positive in 53.3% of endemic controls but none had past history of kala-azar, splenomegaly or hepatomegaly. Rapid diagnostic tests, rK39 and rK28 were found positive in 13.3% and 30% of endemic controls respectively, while rK39 and rK28 ELISA were found positive in 3.3% and 10% subjects respectively. Ln-PCR was found positive in 1 (3.3%) person but all other PCR tools (LAMP, Mini-exon, ITS1, and ITS2) and buffy coat smear were found negative for all endemic controls.

Demographic, clinical and laboratory findings of 30 non-endemic controls are shown in Table 4.2. There were 19 (63.3%) male and 11 (36.7%) female with male to female ratio of 1.73:1 (Fig. 4.1). Mean age was 18.83 ± 1.44 years. None had positive family history or past history of kala-azar. Neither splenomegaly nor hepatomegaly was found in any person. All diagnostic tools were found negative except 1 (3.3%) person found positive for rK28 ICT among non-endemic controls.

Table 4.2 Demographic, clinical and laboratory findings of endemic and non-endemic controls

Character	Endemic controls		Non-endemic controls	
	N=30	Percentage	N=30	Percentage
Sex				
Male	24	80.0	19	63.3
Female	6	20.0	11	36.7
Mean age (Years)	32.20 ± 9.02		18.83 ± 1.44	
F/H of VL				
Yes	16	53.33	00	00
No	14	46.67	30	100
P/H of VL				
Yes	00	00	00	00
No	30	100	30	100
Spleen				
Palpable	00	00	00	00
Not palpable	30	100	30	100
Liver				
Palpable	00	00	00	00
Not palpable	30	100	30	100
rK39 ICT				
Positive	4	13.3	00	00
Negative	26	86.7	30	100
rK28 ICT				
Positive	9	30.0	1	3.3
Negative	21	70.0	29	96.7
rK39 ELISA				
Positive	1	3.3	00	00
Negative	29	96.7	30	100
Ln-PCR				
Positive	3	10.0	00	00
Negative	27	90.0	30	100
LAMP				
Positive	00	00	00	00
Negative	30	100	30	100
Mini-exon PCR				
Positive	1	3.3	00	00
Negative	29	96.7	30	100
ITS1 PCR				
Positive	00	00	00	00
Negative	30	100	30	100
ITS2 PCR				
Positive	00	00	00	00
Negative	30	100	30	100

4.3 Demographic, clinical and laboratory findings of disease controls

Table 4.3 shows the demographic, clinical and laboratory findings of 40 disease controls. Number of male was 27 (67.5%) and female was 13 (32.5%) with male to female ratio of 2.08:1 (Fig. 4.1). Mean age of disease controls was 27.98 ± 17.57 years. None had positive family history or past history of kala-azar. Splenomegaly and hepatomegaly were found in 50% and 27.5% cases respectively. Mild, moderate and severe anaemia were noted among 62.5%, 27.5% and 10% cases respectively. Mild body wasting was present in 33 (82.5%) and moderate wasting in 7 (17.5%) cases. None of disease controls gave history of blackening. Mean duration of fever was 18.65 ± 13.49 weeks and mean ESR was 90.63 ± 31.83 mm in 1st hour. All the diagnostic tools were found negative for disease controls except 3 (7.5%) were positive for rK28 ELISA and 2 (5%) for rK39 ELISA. Clinical diagnosis of 40 disease controls included Pulmonary Tuberculosis (PTB) 13 (32.5%), Chronic Liver Disease (CLD) 8 (20%), Enteric fever 4 (10%), Acute Lymphoblastic Leukaemia (ALL) 3 (7.5%), Chronic Myeloblastic Leukaemia (CML) 3 (7.5%), Pyrexia of Unknown Origin (PUO) 3 (7.5%), Thalassemia 3 (7.5%), Acute Myeloblastic Leukaemia (AML) 1 (2.5%), Liver abscess 1 (2.5%) and Rheumatic fever 1 (2.5%) (Fig. 4.9).

Table 4.3 Demographic, clinical and laboratory findings of disease controls

Characteristics	N=40	Percentage (%)
Sex: Male	27	67.5
Female	13	32.5
Mean age (Years)	27.98 ±17.57	
Mean Fever (Weeks)	18.65 ±13.49	
Mean ESR (mm in 1 st hour)	90.63 ±31.83	
Anaemia: Mild	25	62.5
Moderate	11	27.5
Severe	4	10.0
Wasting: Mild	33	82.5
Moderate	7	17.5
Blackening: Present	00	00
Absent	40	100
Spleen: Palpable	20	50.0
Not palpable	20	50.0
Liver: Palpable	11	27.5
Not palpable	29	72.5
P/H of VL: Yes	00	00
No	40	100
F/H of VL: Yes	00	00
No	40	100
rK39 ICT: Positive	00	00
Negative	40	100
rK28 ICT: Positive	00	00
Negative	40	100
rK39 ELISA: Positive	02	5.0
Negative	38	95.0
rK28 ELISA: Positive	03	7.5
Negative	37	92.5
BC smear: Positive	00	00
Negative	40	100
Ln-PCR: Positive	00	00
Negative	40	100
LAMP: Positive	00	00
Negative	40	100
Mini-exon PCR: Positive	00	00
Negative	40	100
ITS1 PCR: Positive	00	00
Negative	40	100
ITS2 PCR: Positive	00	00
Negative	40	100
Diseases		
- ALL	3	7.5
- AML	1	2.5
- CLD	8	20.0
- CML	3	7.5
- Enteric fever	4	10.0
- Liver abscess	1	2.5
- PTB	13	32.5
- PUO	3	7.5
- Rheumatic fever	1	2.5
- Thalassemia	3	7.5

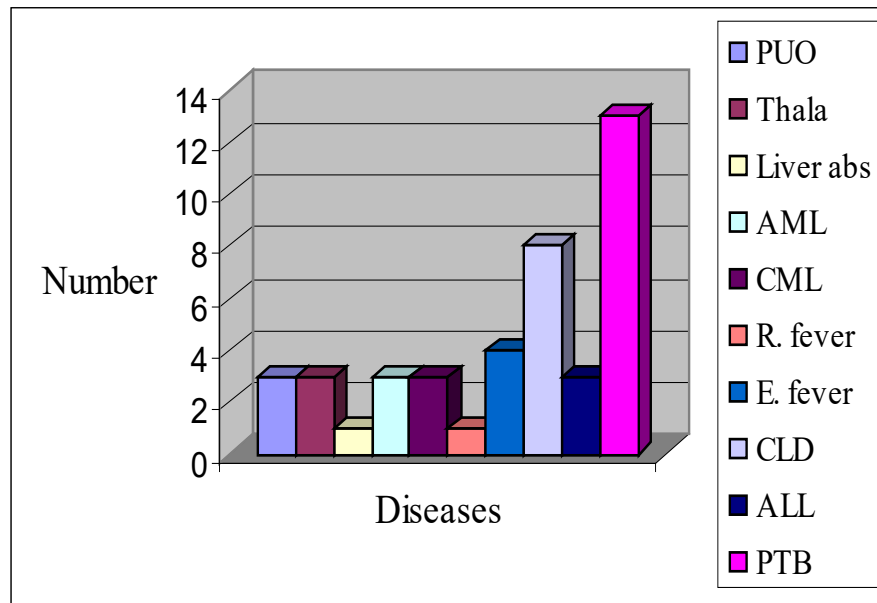

Fig 4.9 Spectrum of diseases and their number among disease controls

4.4 Spleen smear microscopy

Spleen smear microscopy was done for suspected kala-azar patients and 100 smear-positive (demonstration of amastigote form of LD body in smear) (Appendix-12) patients were included as confirmed kala-azar patients. Diagnostic sensitivity of all other tools was determined by comparing with spleen smear positive cases (gold-standard).

Parasite load in the spleen smears for all 100 kala-azar patients was scored in a scale of 1+ to 6+ grades according to Chulay and Bryceson (1983). Different grades of parasite load that were detected among patients are shown in Fig. 4.10. Eight (8%) spleen smears were found to have grade 1+ (1-10 parasites/1000 fields), 41 were grade 2+ (1-10 parasites/100 fields), 34 were grade 3+ (1-10 parasites/10 fields), 10 were grade 4+ (1-10 parasites/field), 6 were 5+ (10-100 parasites/field) and 1 was grade 6+ (100 parasites/field) for parasite load (Appendix-8).

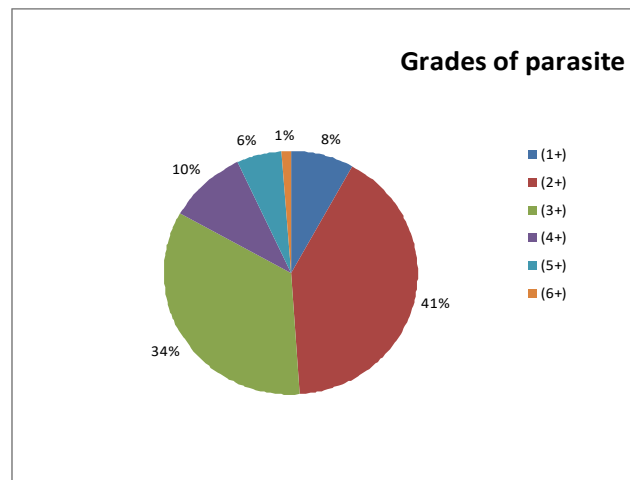

Fig. 4.10 Distribution of grades of parasite load in spleen smears among kala-azar patients

4.5 Results of serological tests

rK39 Immunochromatographic test

rK39 Immunochromatographic test (ICT) was done for all 100 kala-azar patients and 100 controls. Out of 100 patients, 99 (99%) were found positive for this rapid test (Appendix-10). Among 30 endemic controls, 4 (13.33%) were ICT-positive and 26 (86.67%) were negative, while all non-endemic (30) and disease (40) controls were found negative (Fig 4.11).

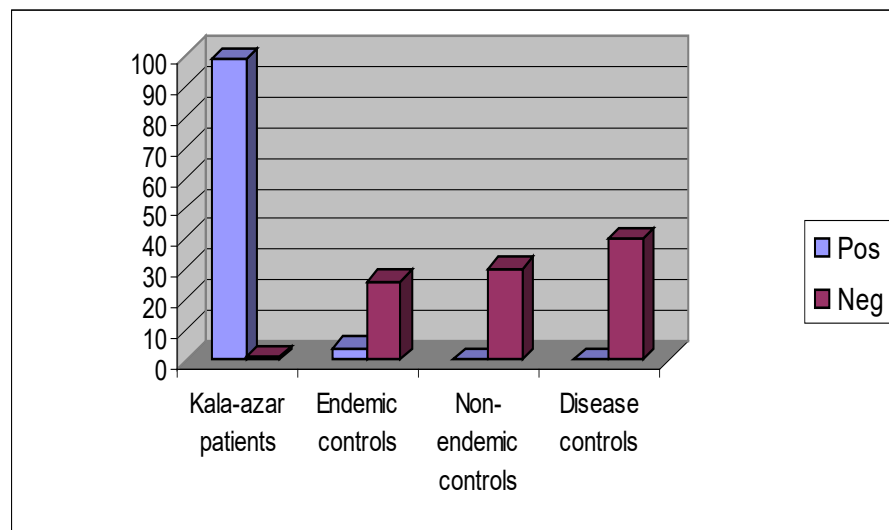

Fig. 4.11 Results of rK39 ICT among study population

Results of rK39 ELISA

rK39 Enzyme linked immunosorbent assay (ELISA) was done for all 100 kala-azar patients and 100 controls. Out of 100 KA patients, 98 (98%) were found positive with Optical Density (OD) >2.3935 (cut off value). Among 30 endemic controls, 1 (3.33%) was ELISA-positive and 29 (96.67%) were negative while among 40 disease controls, 2 (5%) were positive and 38 (95%) were negative. All non-endemic controls were found negative by ELISA (Fig 4.12).

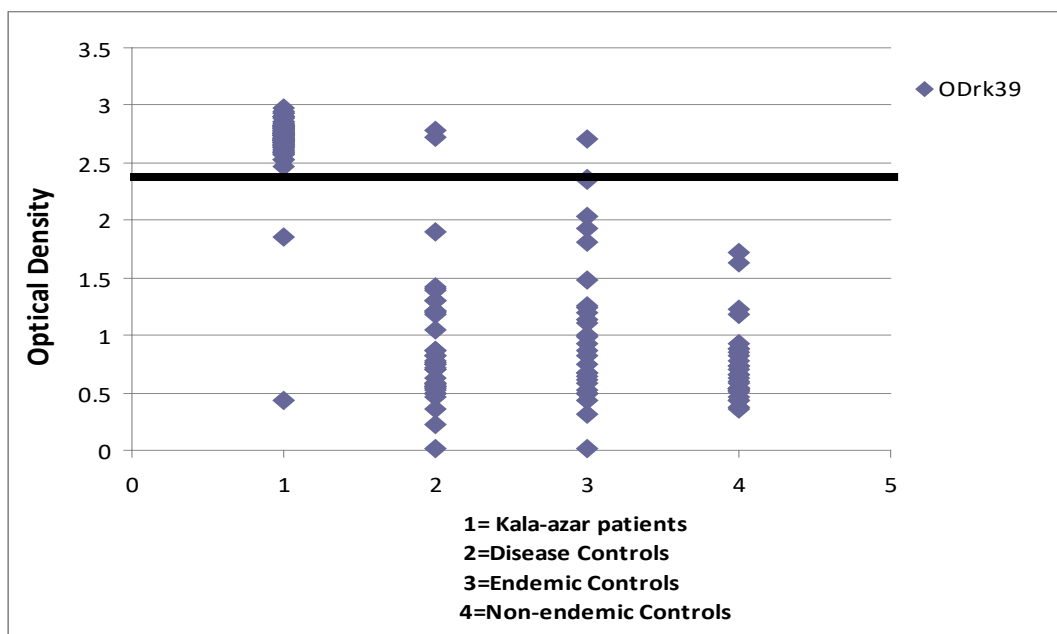

Fig. 4.12 Results of rK39 ELISA among study population (cut off value=2.3935)

Results of rK28 Immunochromatographic test

rK28 Immunochromatographic test (ICT) was done for all 100 kala-azar patients and 100 controls. Out of 100 patients, 99 (99%) were found positive for this rapid test (Appendix-11). Among 30 endemic controls, 9 (30%) were positive and 21 (70%) were negative; while 1 (3.33%) non-endemic control was positive and remaining 29 (96.67%) were negative. All disease controls were found negative by rK28 ICT (Fig. 4.13).

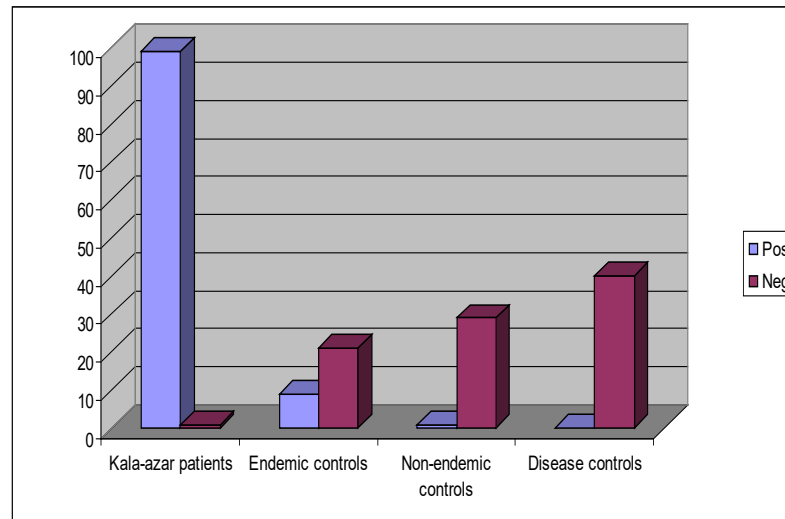

Fig. 4.13 Results of rK28 ICT among study population

Results of rK28 ELISA

rK28 Enzyme linked immunosorbent assay (ELISA) was done for all 100 kala-azar patients and 100 controls. Of 100 KA patients, 98 (98%) were found positive with Optical Density (OD) >1.826 (cut off value). Among 30 endemic controls, 3 (10%) were ELISA-positive and 27 (90%) were negative; while among 40 disease controls, 3 (7.5%) were positive and 37 (92.5%) were negative. All non-endemic controls were found negative in rK28 ELISA (Fig. 4.14).

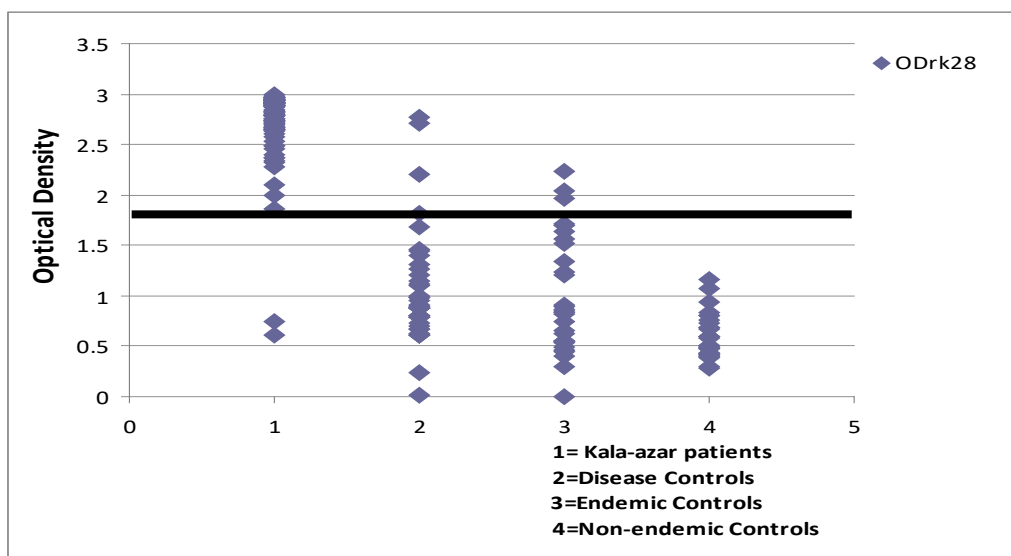

Fig. 4.14 Results of rK28 ELISA among study population (cut off value=1.826)

4.6 Results of buffy coat smear microscopy

Buffy coat smear microscopy for the detection of amastigote of LD body was done for all study population. Out of 100 kala-azar patients, amastigotes were detected in 93 (93%) (Fig. 4.15) and remaining 7 (7%) were negative. All 100 controls were found negative by buffy coat smear microscopy.

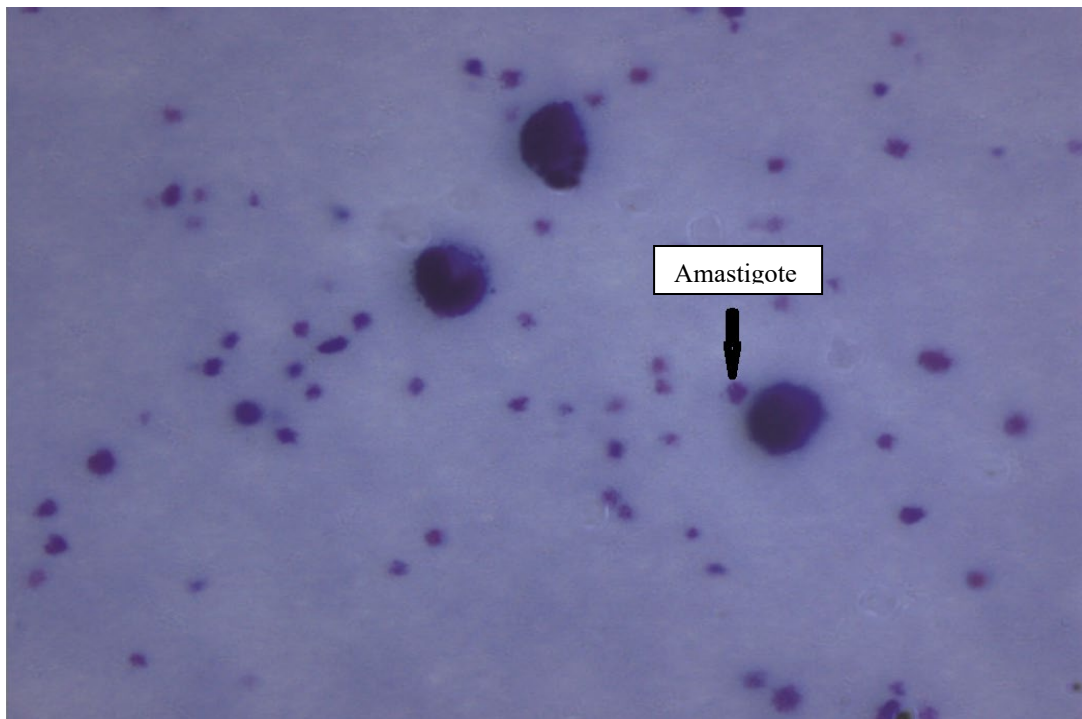

Fig. 4.15 Buffy coat smear microscopy showing amastigote form of LD body (10x 100 magnification)

4.7 Results of different PCR methods

Ln-PCR, Mini-exon, ITS1 and ITS2 PCR were carried out for study population. Out of 100 kala-azar patients, Ln-PCR, Mini-exon, ITS1 and ITS2 PCR were found positive in 94 (94%), 86 (86%), 85 (85%) and 80 (80%) cases respectively (Fig. 4.16). All controls were found negative for different PCR methods, except 1 person from endemic controls was found positive in Ln-PCR.

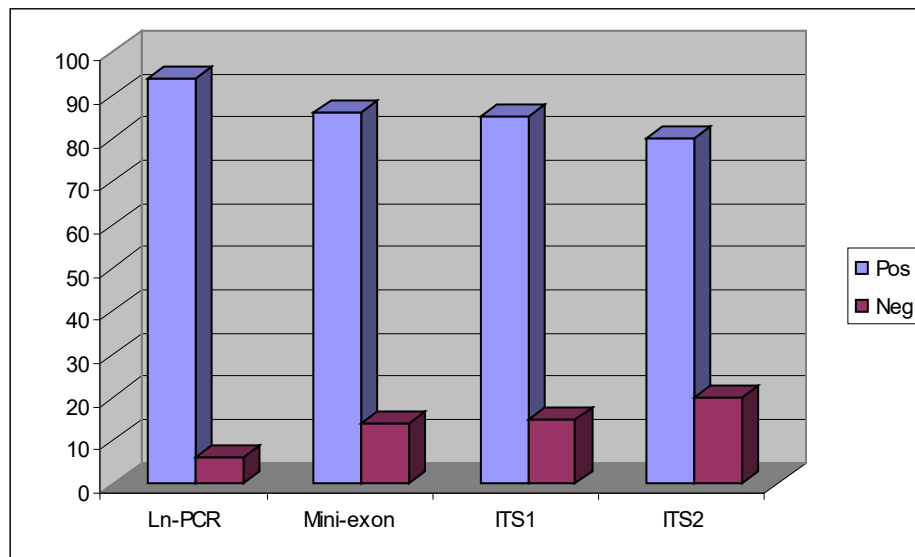

Fig. 4.16 Results of different PCR methods among kala-azar patients

Gel documentations of PCR amplified products

PCR amplified products in gel electrophoresis from kala-azar patients for Ln-PCR (358 bp), Mini-exon PCR (378-435 bp), ITS1 PCR (320 bp) and ITS2 PCR (740 bp) are shown in Fig. 4.17, Fig. 4.18, Fig. 4.19 and Fig. 4.20 respectively.

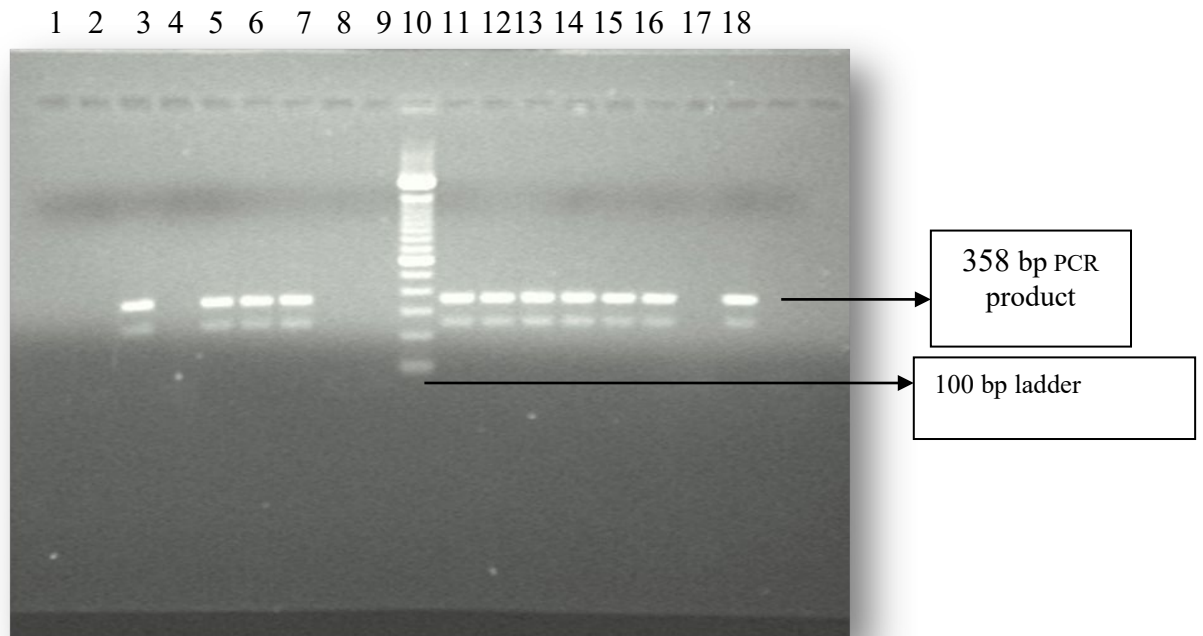

Fig 4.17 Gel electrophoresis pattern of Ln-PCR amplified products from extracted DNA samples Lane 01=Blank, Lane 03, 05, 06, 07, 12, 13, 14, 15, 16 and 18 indicate 358 bp amplification bands observed from kala-azar patient's samples, Lane 02, 04, 08 and 09 indicate no amplification observed from control's samples, Lane 11= positive control and Lane =17 indicates negative control (molecular grade water), Lane 10= 100 bp DNA ladder.

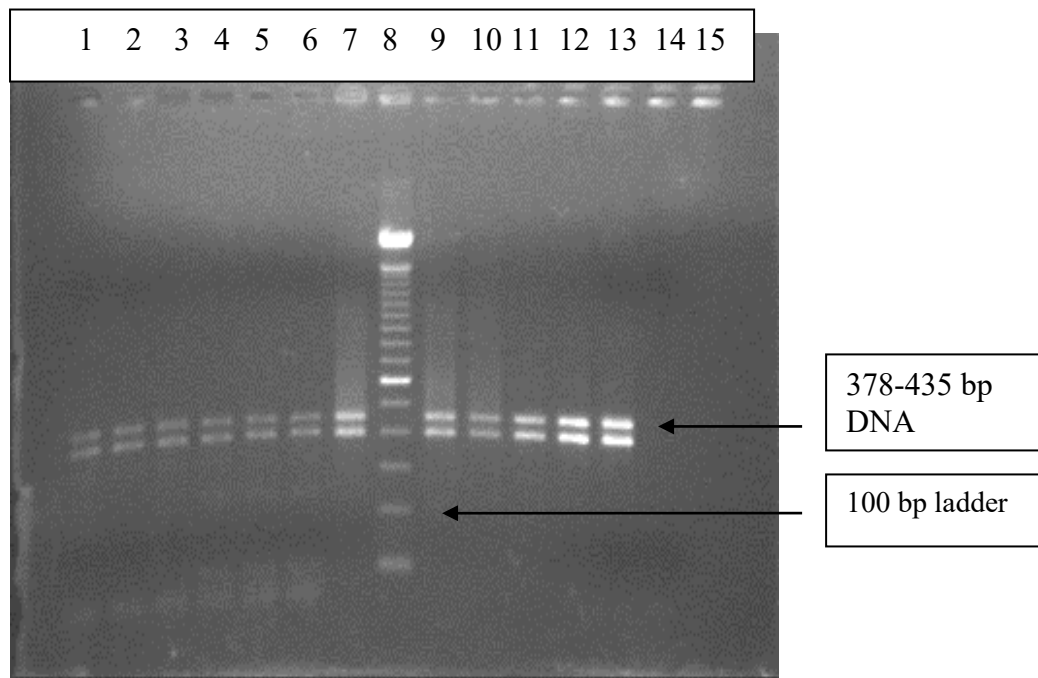

Fig. 4.18 Gel electrophoresis pattern of Mini-exon amplified products from extracted buffy coat DNA samples. Lane 01, 02, 03, 04, 05, 06, 09, 10, 11, 12 and 13 indicate amplification products ranging from 378 to 435 bp observed from VL patient samples, Lane 07= positive control, Lane 14 indicates no amplification from control, and Lane =15 indicates negative control (molecular grade water), Lane 08= 100 bp DNA ladder.

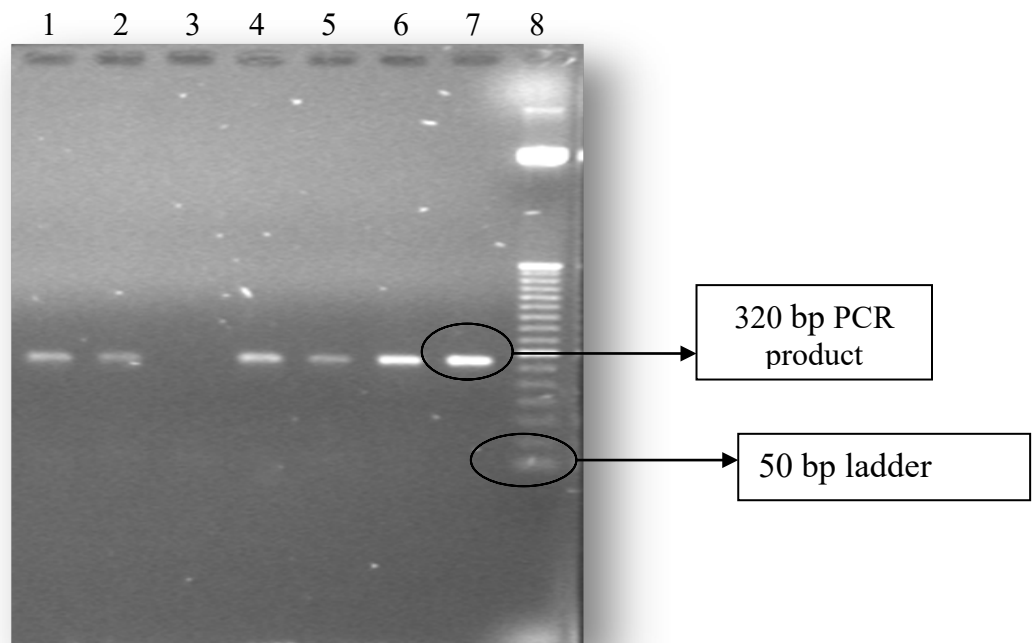

Fig. 4.19 Gel electrophoresis pattern of ITS1 PCR amplified products from extracted DNA samples. Lane 01, 02, 04, 05 and 06 indicates 320 bp amplification product detected from kala-azar patients, Lane 03= negative control (dH₂O), Lane 07= positive control, Lane 08= 50 bp DNA ladder.

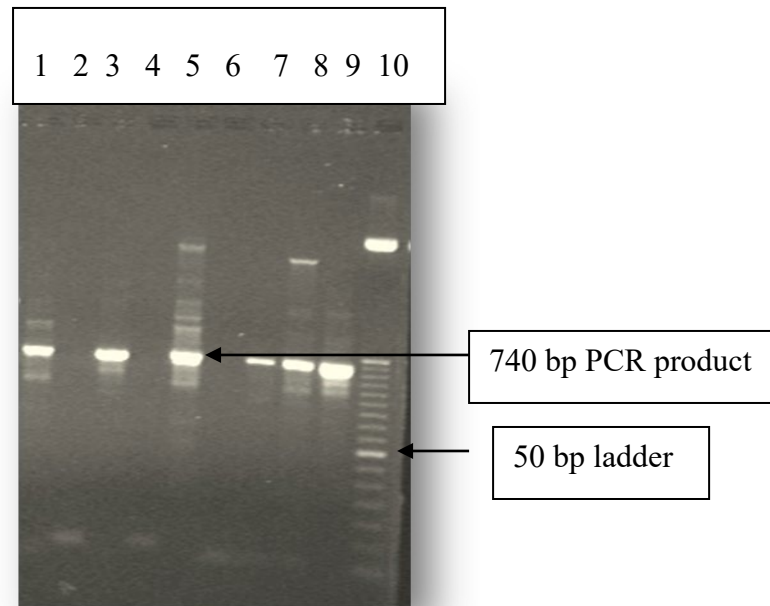

Fig. 4.20 Gel electrophoresis pattern of ITS2 PCR amplified products from extracted buffy coat DNA samples. Lane 01, 03, 05, 07, 08 and 09 indicates 740 bp amplification product detected from kala-azar patients, Lane 06= negative control (dH₂O), Lane 09= positive control, Lane 02= disease control, Lane 04= healthy control, Lane 10= 50 bp DNA ladder.

4.8 Results of Loop-mediated isothermal amplification (LAMP)

LAMP was carried out with buffy coat extracted DNA from all study population. Out of 100 kala-azar patients, it was found positive in 89 (89%) and negative in 11 (11%). All controls were found negative by LAMP. Positive and negative results of LAMP (visualized by naked eye) and its amplified products in gel are shown in Fig. 4.21 A and Fig. 4.21 B respectively.

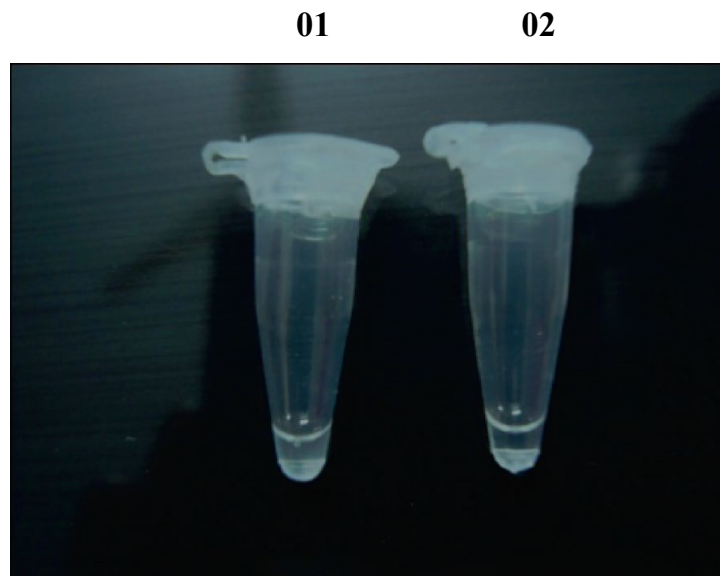

Fig. 4.21A Naked eye visualization of LAMP products

01 = LAMP-positive as indicated by turbidity from kala-azar patient's sample,
02 = LAMP-negative as indicated by absence of turbidity from control's sample.

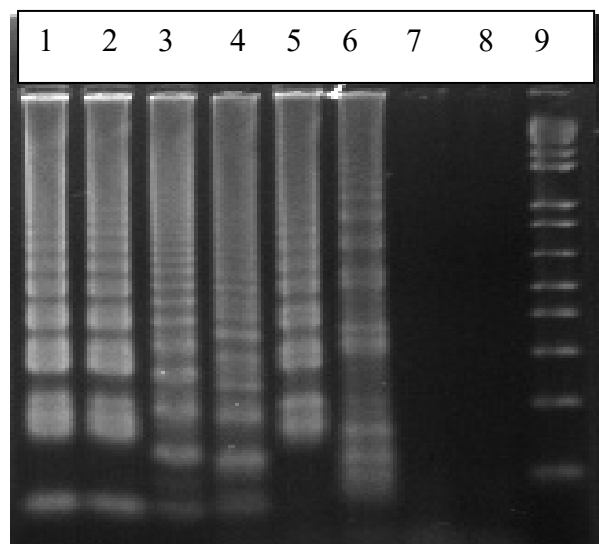

Fig. 4.21B Gel electrophoresis pattern of LAMP amplified products from extracted buffy coat DNA samples. Lane 01, 02, 03, 04, 05, 06 indicate positive amplification products from VL patients. Lane 07 indicates no product from control, Lane 08= negative control (PCR grade water) and Lane 09= 100 bp DNA ladder.

4.9 Diagnostic indices of different tools for kala-azar

Sensitivity, Specificity and diagnostic accuracy at 95% confidence interval (CI) of different tools for kala-azar are summarized in Table 4.4. Diagnostic sensitivity, specificity and accuracy for rK39 ICT were 99%, 96% and 95%, for rK39 ELISA, 98%, 97% and 95%, for rK28 ICT, 99%, 90% and 89%, for rK28 ELISA, 98%, 94% and 92%, for buffy coat smear microscopy, 93%, 100% and 93%, for Ln-PCR, 94%, 99% and 93%, for LAMP, 89%, 100% and 89%, for Mini-exon PCR, 86%, 100% and 86%, for ITS1 PCR, 85%, 100% and 85% and for ITS2 PCR, 80%, 100% and 80% respectively. Sensitivity and specificity of different diagnostic tools for kala-azar are shown in Fig. 4.22 and Fig. 4.23 respectively.

Table 4.4 Diagnostic indices of different tools for kala-azar

Tools	Sensitivity (95% CI)	Specificity (95% CI)	Accuracy [Kappa (P-value)] (95% CI)
rK39 ICT	99% (93.75-99.94)	96% (89.84-98.71)	95% (90.67-99.33)
rK39 ELISA	98% (92.26-99.65)	97% (90.84-99.22)	95% (90.67-99.33)
rK28 ICT	99% (93.75-99.94)	90% (81.96-94.83)	89% (82.68-95.32)
rK28 ELISA	98% (92.26-99.65)	94% (86.88-97.53)	92% (86.57-97.43)
Buffy coat smear	93% (85.62-96.89)	100% (95.38-100)	93% (87.91-98.09)
Ln-PCR	94% (86.88-97.53)	99% (93.75-99.94)	93% (87.91-98.09)
LAMP	89% (80.77-94.11)	100% (95.38-100)	89% (82.68-95.32)
Mini-exon PCR	86% (77.28-91.85)	100% (95.38-100)	86% (78.93-93.07)
ITS1 PCR	85% (76.14-91.08)	100% (95.38-100)	85% (77.70-92.30)
ITS2 PCR	80% (70.56-87.07)	100% (95.38-100)	80% (71.68-88.32)

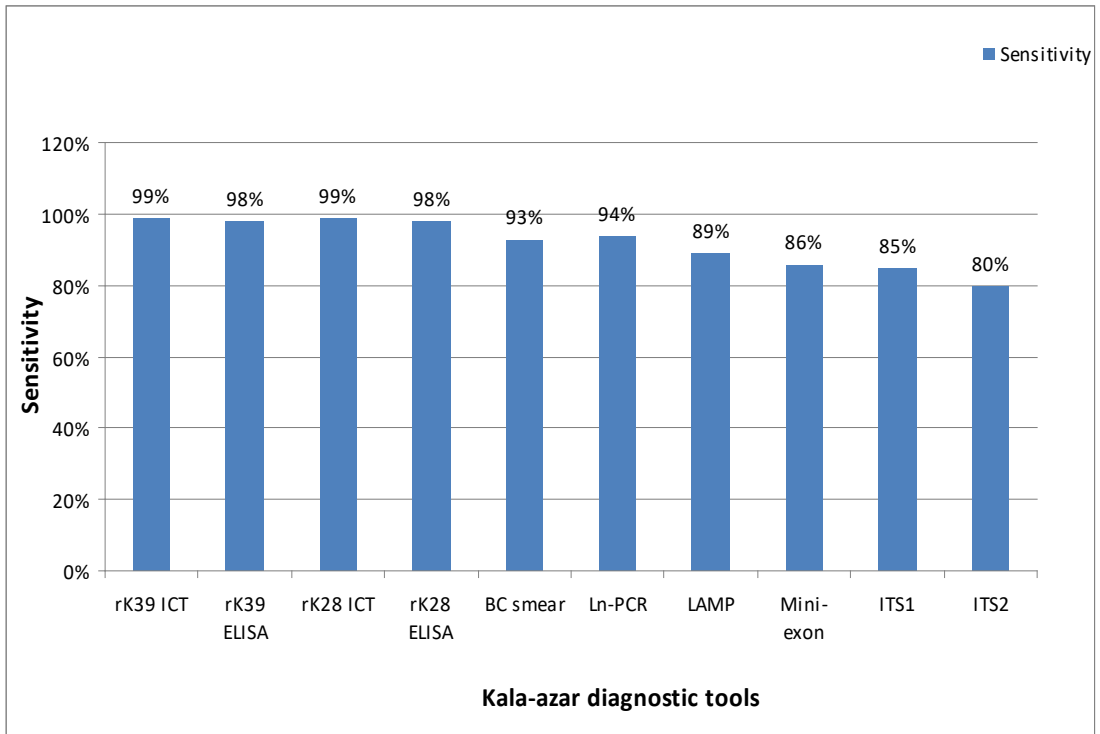

Fig. 4.22 Sensitivity of different diagnostic tools for kala-azar

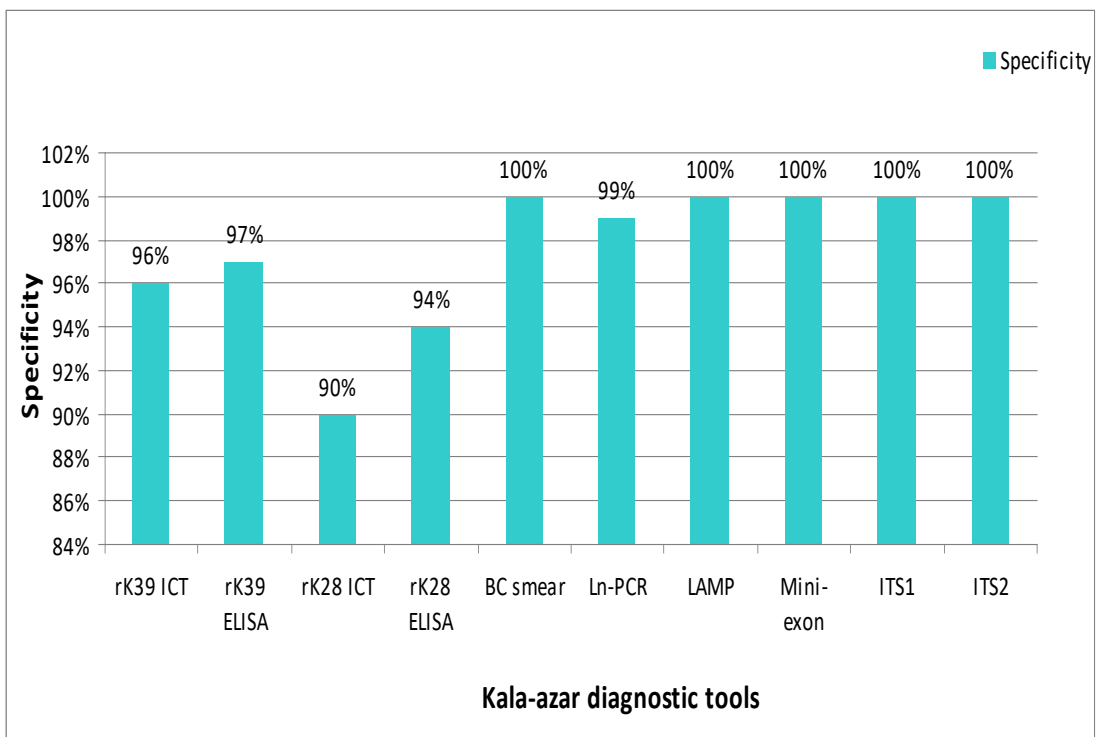

Fig. 4.23 Specificity of different diagnostic tools for kala-azar

4.10 Correlations

4.10.1 Spearman correlations of different tools against spleen smear

Spearman correlations of rK39 ICT, rK39 ELISA, rK28 ICT, rK28 ELISA, buffy coat smear, Ln-PCR, LAMP, Mini-exon PCR, ITS1 PCR and ITS2 PCR with that of spleen smear (gold standard) were 0.950, 0.950, 0.894, 0.921, 0.932, 0.931, 0.895, 0.869, 0.860 and 0.816 respectively and P values of all tools were found to be highly significant (P=0.0001) (Table 4.5).

Table 4.5 Spearman correlations (Spleen smear vs. others)

Diagnostic tools	Spleen smear			Spearman correlation (P-value)
		Pos	Neg	
rK39 ICT	Pos	99	4	0.950 (0.0001)
	Neg	1	96	
rK39 ELISA	Pos	98	3	0.950 (0.0001)
	Neg	2	97	
rK28 ICT	Pos	99	10	0.894 (0.0001)
	Neg	1	90	
rK28 ELISA	Pos	98	6	0.921 (0.0001)
	Neg	2	94	
Buffy coat smear	Pos	93	0	0.932 (0.0001)
	Neg	7	100	
Ln-PCR	Pos	94	1	0.931 (0.0001)
	Neg	6	99	
LAMP	Pos	89	0	0.895 (0.0001)
	Neg	11	100	
Mini-exon PCR	Pos	86	0	0.869 (0.0001)
	Neg	14	100	
ITS1 PCR	Pos	85	0	0.860 (0.0001)
	Neg	15	100	
ITS2 PCR	Pos	80	0	0.816 (0.0001)
	Neg	20	100	

4.10.2 Spearman correlations of different serodiagnostic tools

Performance of serodiagnostic tool, rK28 ICT was compared with rK39 ICT and significant ($P=0.0001$) Spearman correlation of 0.942 was noted (Table 4.6). Similarly, performance of rK28 ELISA was compared with rK39 ELISA and significant ($P=0.0001$) Spearman correlation of 0.930 was found (Table 4.7).

Table 4.6 Correlation of performance between RDTs (rK28 vs. rK39)

		rK39 ICT		
		Pos	Neg	Total
rK28 ICT	Pos	103	6	109
	Neg	0	91	91
	Total	103	97	200

Spearman correlation: 0.942 ($P=0.0001$)

Table 4.7 Correlation of performance between ELISA (rK28 vs. rK39)

		rK39 ELISA		
		Pos	Neg	Total
rK28 ELISA	Pos	99	5	104
	Neg	2	94	96
	Total	101	99	200

Spearman correlation: 0.930 ($P=0.0001$)

4.11 McNemar pair test of diagnostic tools against spleen smear

McNemar pair test of diagnostic tools against spleen smear was done and P-values of rK39 ICT, rK39 ELISA, rK28 ICT, rK28 ELISA, Buffy coat smear, Ln-PCR, LAMP, Mini-exon PCR, ITS1 PCR and ITS2 PCR were found to be 0.375, 1.000, 0.012, 0.289, 0.016, 0.125, 0.001, 0.0001, 0.0001 and 0.0001 respectively (Table 4.8). P-values were found significant (<0.05) for Buffy coat smear, Ln-PCR, LAMP, Mini-exon PCR, ITS1 PCR and ITS2 PCR.

Table 4.8 McNemar pair test results (Spleen smear vs. other tools)

Diagnostic tools		Spleen smear		McNemar test (P-value)
		Pos	Neg	
rK39 ICT	Pos	99	4	0.375
	Neg	1	96	
rK39 ELISA	Pos	98	3	1.000
	Neg	2	97	
rK28 ICT	Pos	99	10	0.012
	Neg	1	90	
rK28 ELISA	Pos	98	6	0.289
	Neg	2	94	
Buffy coat smear	Pos	93	0	0.016
	Neg	7	100	
Ln-PCR	Pos	94	1	0.125
	Neg	6	99	
LAMP	Pos	89	0	0.001
	Neg	11	100	
Mini-exon PCR	Pos	86	0	0.0001
	Neg	14	100	
ITS1 PCR	Pos	85	0	0.0001
	Neg	15	100	
ITS2 PCR	Pos	80	0	0.0001
	Neg	20	100	

McNemar pair test between Ln-PCR and other PCR methods

McNemar pair test was done between Ln-PCR and other PCR methods. A P value of 0.049 was found between Ln-PCR and Mini-exon PCR (Table 4.9), P=0.013 between Ln-PCR and ITS1 PCR (Table 4.10) and P=0.001 between Ln-PCR and ITS2 PCR (Table 4.11). P-values for all PCR in respect to Ln-PCR were found significant (<0.05).

Table 4.9 McNemar pair test between Ln-PCR and Mini-exon PCR

		Ln-PCR		
		Pos	Neg	Total
Mini-exon PCR	Pos	82	4	86
	Neg	13	101	114
	Total	95	105	200

McNemar test: P= 0.049

Table 4.10 McNemar pair test between Ln-PCR and ITS1 PCR

		Ln-PCR		
		Pos	Neg	Total
ITS1 PCR	Pos	83	2	85
	Neg	12	103	115
	Total	95	105	200

McNemar test: P= 0.013

Table 4.11 McNemar pair test between Ln-PCR and ITS2 PCR

		Ln-PCR		
		Pos	Neg	Total
ITS2 PCR	Pos	78	2	80
	Neg	17	103	120
	Total	95	105	200

McNemar test: P= 0.001

4.12 Comparison of performance of diagnostic tools in respect to spleen smear parasite load

Diagnostic performances of diagnostic tools was compared with different grades of spleen smear parasite load are shown in Table 4.12. Buffy coat smear was found positive for all patients having grades $\geq 3+$ parasite load. Its positivity decreased to 37.5% among grade 1+ and 95.12% among grade 2+ patients. Higher parasitic load was significantly (P=0.0001) related to buffy coat smear positivity. Ln-PCR was found 100% positive among grades 1+, 5+ and 6+ cases but positivity decreased to 97.56%, 98.18% and 80% among 2+, 3+ and 4+ patients respectively. LAMP was found 100% positive among grades 1+, 4+ and 6+ but was found negative in 9.75%, 17.65% and 20% cases among 2+, 3+ and 5+ grades of parasite load respectively. Mini-exon PCR was cent percent positive among grades 5+ and 6+ but was negative in 12.5%, 12.19%, 17.65% and 20% cases among 1+, 2+, 3+ and 4+ grades respectively. ITS1 PCR was found positive in 87.5%, 85.36%, 85.29%, 80%, 83.33% and 100% cases among grades 1+, 2+, 3+, 4+, 5+ and 6+ respectively. ITS2 PCR was found positive in 75%, 82.92%, 76.47%, 90%, 83.33% and 0% cases among grades 1+, 2+, 3+, 4+, 5+ and 6+ respectively. Higher parasitic load was not significantly correlated with performance of Ln-PCR (P=0.323), LAMP (P=0.529), Mini-exon PCR (P=0.857), ITS1 PCR (P=0.994) and ITS2 PCR (P=0.383).

Table 4.12 Diagnostic performances of different tools in respect to different grades of parasite load in spleen smear

		Parasite load in spleen smear							
		Grades	1+ N=8	2+ N=41	3+ N=34	4+ N=10	5+ N=6	6+ N=1	
Tools		N (%)	N (%)	N (%)	N (%)	N (%)	N (%)	P-value	
BC smear	Pos	3 (37.5)	39 (95.12)	34 (100)	10 (100)	6 (100)	1 (100)	<0.0001	
Ln-PCR	Pos	8 (100)	40 (97.56)	31 (91.17)	8 (80)	6 (100)	1 (100)	0.323	
LAMP	Pos	8 (100)	37 (90.24)	28 (82.35)	10 (100)	5 (83.33)	1 (100)	0.529	
Mini-exon PCR	Pos	7 (87.5)	36 (87.8)	28 (82.35)	8 (80)	6 (100)	1 (100)	0.857	
ITS1 PCR	Pos	7 (87.5)	35 (85.36)	29 (85.29)	8 (80)	5 (83.33)	1 (100)	0.994	
ITS2 PCR	Pos	6 (75)	34 (100)	26 (76.47)	9 (90)	5 (83.33)	0 (00)	0.383	

4.13 ROC analysis of diagnostic tools for sensitivity and specificity

4.13.1 ROC comparison of molecular tools against gold standard (spleen smear)

Diagnostic sensitivity and specificity of molecular tools were compared to gold standard by ROC (Receiver Operating Characteristic) analysis (Fig. 4.24) (DeLong *et al.*, 1988). Table 4.13 shows the Area under the ROC curve (AUC) of different molecular tools with Standard Error (SE) at 95% CI. AUC of Ln-PCR, LAMP, Mini-exon PCR, ITS1 PCR and ITS2 PCR were 0.965 (95% CI, 0.929 to 0.986), 0.945 (95% CI, 0.904 to 0.972), 0.930 ((95% CI, 0.885 to 0.961), 0.925 (95% CI, 0.879 to 0.957), and 0.900 (95% CI, 0.850 to 0.938) respectively.

Pair-wise comparison of ROC curves are shown in Table 4.14a and 4.14b. ROC curves were found statistically significant between Ln-PCR vs. ITS1 PCR (P=0.0283), Ln-PCR vs. ITS2 PCR (P=0.0017) and LAMP vs. ITS2 PCR (P = 0.0260). While pair-wise comparison between Ln-PCR vs. LAMP (P=0.2454), Ln-PCR vs. Mini-exon PCR (P=0.0850), LAMP vs. Mini-exon PCR (P = 0.4061), LAMP vs. ITS1 PCR (P = 0.3460), Mini-exon vs. ITS1 PCR (P = 0.8281), Mini-exon vs. ITS2 PCR (P = 0.1779) and ITS1 vs. ITS2 PCR (P = 0.1635) were all statistically insignificant.

Table 4.13 AUC of different molecular tools in ROC

Diagnostic Tools	AUC	SE	95% CI
Ln-PCR	0.965	0.0129	0.929 to 0.986
LAMP	0.945	0.0157	0.904 to 0.972
Mini-exon PCR	0.930	0.0174	0.885 to 0.961
ITS1 PCR	0.925	0.0179	0.879 to 0.957
ITS2 PCR	0.900	0.0201	0.850 to 0.938

Table 4.14a Pair-wise comparison of Ln-PCR vs. LAMP and other PCR methods

Ln-PCR ~ LAMP	
Difference between areas	0.0200
Standard Error	0.0172
95% Confidence Interval	-0.0137 to 0.0537
z statistic	1.162
Significance level	P = 0.2454
Ln-PCR ~ Mini-exon PCR	
Difference between areas	0.0350
Standard Error	0.0203
95% Confidence Interval	-0.00483 to 0.0748
z statistic	1.722
Significance level	P = 0.0850
Ln-PCR ~ ITS1 PCR	
Difference between areas	0.0400
Standard Error	0.0182
95% Confidence Interval	0.00424 to 0.0758
z statistic	2.193
Significance level	P = 0.0283
Ln-PCR ~ ITS2 PCR	
Difference between areas	0.0650
Standard Error	0.0207
95% Confidence Interval	0.0244 to 0.106
z statistic	3.134
Significance level	P = 0.0017

Table 4.14b Pair-wise comparison of LAMP vs. PCR methods, Mini-exon PCR vs. other PCR methods and ITS1 PCR vs. ITS2 PCR

LAMP ~ Mini-exon PCR	
Difference between areas	0.0150
Standard Error	0.0181
95% Confidence Interval	-0.0204 to 0.0504
z statistic	0.831
Significance level	P = 0.4061
LAMP ~ ITS1 PCR	
Difference between areas	0.0200
Standard Error	0.0212
95% Confidence Interval	-0.0216 to 0.0616
z statistic	0.942
Significance level	P = 0.3460
LAMP ~ ITS2 PCR	
Difference between areas	0.0450
Standard Error	0.0202
95% Confidence Interval	0.00537 to 0.0846
z statistic	2.226
Significance level	P = 0.0260
Mini-exon PCR ~ ITS1 PCR	
Difference between areas	0.00500
Standard Error	0.0230
95% Confidence Interval	-0.0401 to 0.0501
z statistic	0.217
Significance level	P = 0.8281
Mini-exon PCR ~ ITS2 PCR	
Difference between areas	0.0300
Standard Error	0.0223
95% Confidence Interval	-0.0136 to 0.0736
z statistic	1.347
Significance level	P = 0.1779
ITS1 ~ ITS2 PCR	
Difference between areas	0.0250
Standard Error	0.0179
95% Confidence Interval	-0.0102 to 0.0602
z statistic	1.393
Significance level	P = 0.1635

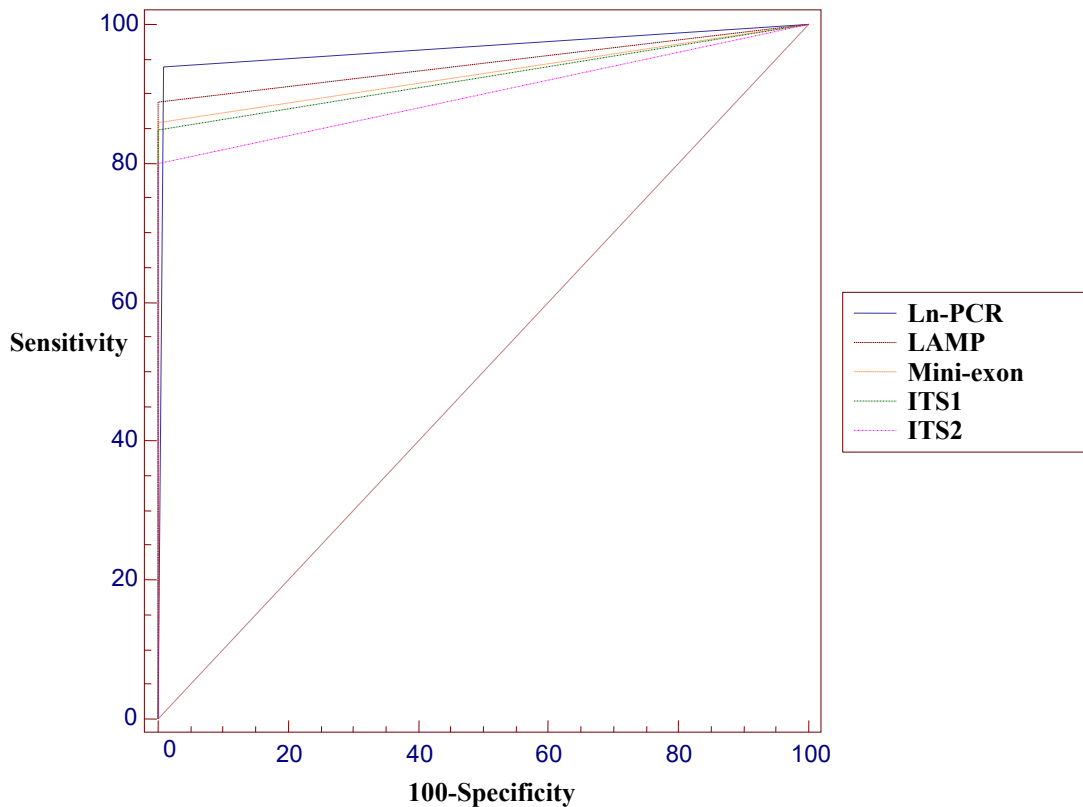

Fig. 4.24 ROC curves showing comparison of molecular diagnostic tools with gold standard (spleen smear)

4.13.2 ROC comparison of serological tools and buffy coat smear against gold standard (spleen smear)

Diagnostic sensitivity and specificity of serological tools and buffy coat smear were compared to gold standard by ROC analysis (Fig. 4.25). Table 4.15 shows the AUC of different tools with Standard Error (SE) at 95% CI. AUC of rK39 ICT, rK39 ELISA, rK28 ICT, rK28 ELISA and buffy coat smear were 0.975 (95% CI, 0.943 to 0.992), 0.975 (95% CI, 0.943 to 0.992), 0.945 ((95% CI, 0.904 to 0.972), 0.960 (95% CI, 0.923 to 0.983), and 0.965 (95% CI, 0.929 to 0.986) respectively.

Table 4.15 AUC of different serological tools and buffy coat smear in ROC

Diagnostic Tools	AUC	SE	95% CI
rK39 ICT	0.975	0.0110	0.943 to 0.992
rK39 ELISA	0.975	0.0111	0.943 to 0.992
rK28 ICT	0.945	0.0159	0.904 to 0.972
rK28 ELISA	0.960	0.0139	0.923 to 0.983
Buffy coat smear	0.965	0.0128	0.929 to 0.986

Pair-wise comparison of ROC curves are shown in Table 4.16a and 4.16b. ROC curves were found statistically significant only between rK39 ICT vs. rK28 ICT (P=0.0119), all remaining comparisons found insignificant (P> 0.05).

Table 4.16a Pair-wise comparison of rK39 ICT vs. others

rK39 ICT ~ rK39 ELISA	
Difference between areas	2.3318E-015
Standard Error	0.0142
95% Confidence Interval	-0.0278 to 0.0278
z statistic	1.6422E-013
Significance level	P = 1.0000
rK39 ICT ~ rK28 ICT	
Difference between areas	0.0300
Standard Error	0.0119
95% Confidence Interval	0.00661 to 0.0534
z statistic	2.514
Significance level	P = 0.0119
rK39 ICT ~ rK28 ELISA	
Difference between areas	0.0150
Standard Error	0.0166
95% Confidence Interval	-0.0176 to 0.0476
z statistic	0.902
Significance level	P = 0.3670
rK39 ICT ~ Buffy coat smear	
Difference between areas	0.01000
Standard Error	0.0155
95% Confidence Interval	-0.0203 to 0.0403
z statistic	0.646
Significance level	P = 0.5181

Table 4.16b Pair-wise comparison between serological tools and buffy coat

rK39 ELISA ~ rK28 ICT	
Difference between areas	0.0300
Standard Error	0.0185
95% Confidence Interval	-0.00619 to 0.0662
z statistic	1.625
Significance level	P = 0.1042
rK39 ELISA ~ rK28 ELISA	
Difference between areas	0.0150
Standard Error	0.0132
95% Confidence Interval	-0.0109 to 0.0409
z statistic	1.136
Significance level	P = 0.2562
rK39 ELISA ~ Buffy coat smear	
Difference between areas	0.01000
Standard Error	0.0172
95% Confidence Interval	-0.0236 to 0.0436
z statistic	0.583
Significance level	P = 0.5600
rK28 ICT ~ rK28 ELISA	
Difference between areas	0.0150
Standard Error	0.0206
95% Confidence Interval	-0.0254 to 0.0554
z statistic	0.728
Significance level	P = 0.4669
rK28 ICT ~ Buffy coat smear	
Difference between areas	0.0200
Standard Error	0.0192
95% Confidence Interval	-0.0177 to 0.0577
z statistic	1.040
Significance level	P = 0.2983
rK28 ELISA ~ Buffy coat smear	
Difference between areas	0.00500
Standard Error	0.0191
95% Confidence Interval	-0.0324 to 0.0424
z statistic	0.262
Significance level	P = 0.7931

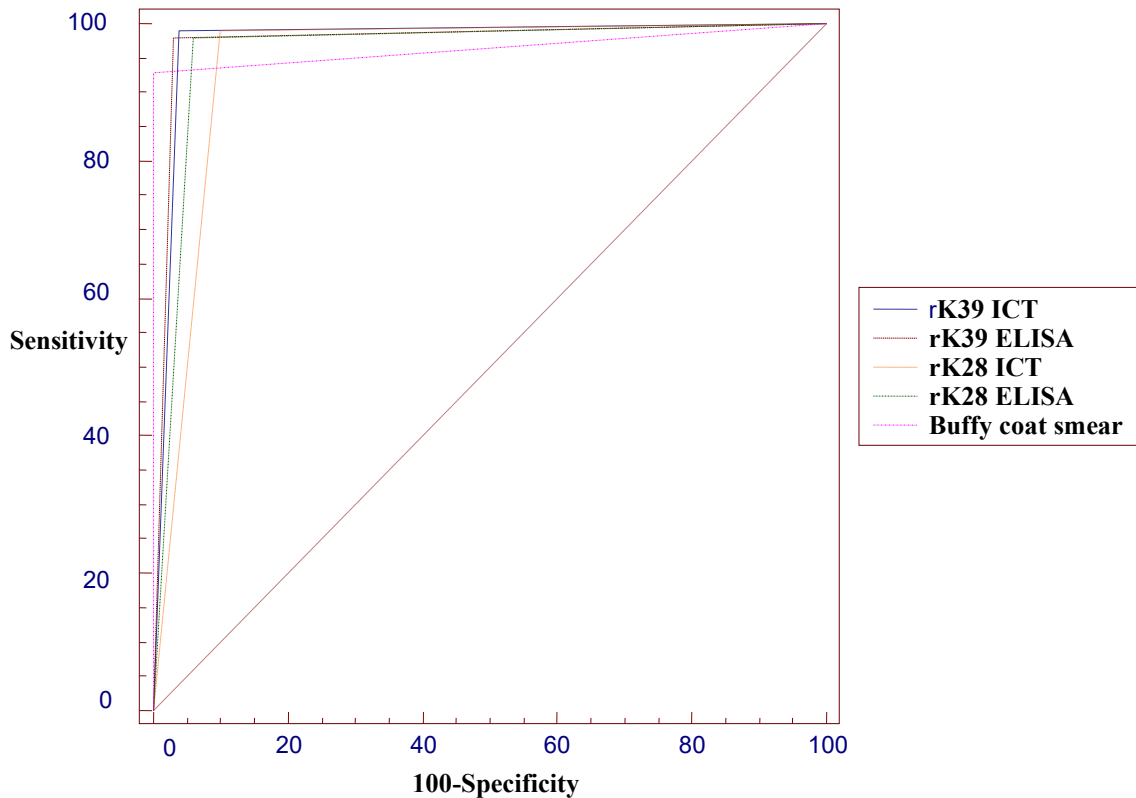

Fig. 4.25 ROC curves showing comparison of serological tools and buffy coat smear with gold standard (spleen smear)

4.14 Index analysis of diagnostic tools for evaluation of ranking

Diagnostic tools were scored for Index analysis. Description of indicators pertinent to characteristics of different diagnostic tools along with their score is shown in Table 4.17. Diagnostic accuracy (kappa value), cost, interpretation of test result, availability, user friendliness, test type and potential for field use were considered for evaluating scores (0 to 4).

Diagnostic tools for kala-azar were ranked based on calculated index score for each tool and are shown in Table 4.18. It is evident from this indexing score that rK39 ICT was the best diagnostic option (Rank#1, Index score = 1.65335) followed by rK28 ICT (Rank#2, Index score = 1.48776), Buffy coat smear microscopy (Rank#3, Index score = 0.50764), rK39 ELISA (Rank#4, Index score = 0.2963), rK28 ELISA (Rank#5, Index score = 0.2963), Ln-PCR (Rank#6, Index

score = - 0.7158), LAMP (Rank#7, Index score = -0.88139), Mini-exon PCR (Rank#8, Index score = -0.88139) ITS1 PCR (Rank#9, Index score = -0.88139), and ITS2 PCR (Rank#10, Index score = -0.88139) for kala-azar.

Table 4.17 Scoring of diagnostic tools based on different indicators

Indicators	Description	Score
Kappa	Diagnostic accuracy of test was evaluated by its kappa value and higher score was given to test having high kappa value.	0 = low (<80%) 1 = high ($\geq 80\%$ to <90%) 2 = higher ($\geq 90\%$)
Cost	Cost in US dollar (USD) was estimated for each test and higher score was given to less costly test.	0 = ≥ 20 USD 1 = ≥ 15 to <20 USD 2 = ≥ 10 to <15 USD 3 = ≥ 5 to <10 USD 4 = <5 USD
Interpretation	Ease of interpretation of test result was considered and higher score was given to test with easiest interpretation.	0 = not easy 1 = easy 2 = easier 3 = easiest
Availability	Availability of test in different levels of health care facilities was considered and higher score was given to test available at field.	0 = tertiary level 1 = secondary level 2 = field level
User friendliness	User friendliness of test was considered and higher score was given to test which is more users friendly.	0 = not friendly 1 = friendly 2 = more friendly 3 = most friendly
Test type	Test detecting parasite was scored highest followed by DNA and antibody detection.	0 = Ab detection 1 = DNA detection 2 = parasite detection
Potentiality	Potential of test to be used as point-of-care test (field) was given highest score.	0 = tertiary level 1 = secondary level 2 = field level

Table 4.18 Ranking of diagnostic tools for kala-azar based on index calculated from inherent features

VL Diagnostic Tools	Index Score	Rank (Index)
rK39 ICT	1.65335	1
rK28 ICT	1.48776	2
Buffy coat smear microscopy	0.50764	3
rK39 ELISA	0.2963	4
rK28 ELISA	0.2963	5
Ln-PCR	-0.7158	6
LAMP	-0.88139	7
Mini-exon PCR	-0.88139	8
ITS1 PCR	-0.88139	9
ITS2 PCR	-0.88139	10

4.15 Proposed diagnostic algorithm for kala-azar in Bangladesh

Clinical suspects (case definition) of kala-azar

(Lives in endemic area, fever >2wks, splenomegaly, with or without anaemia, body wasting, blackening)

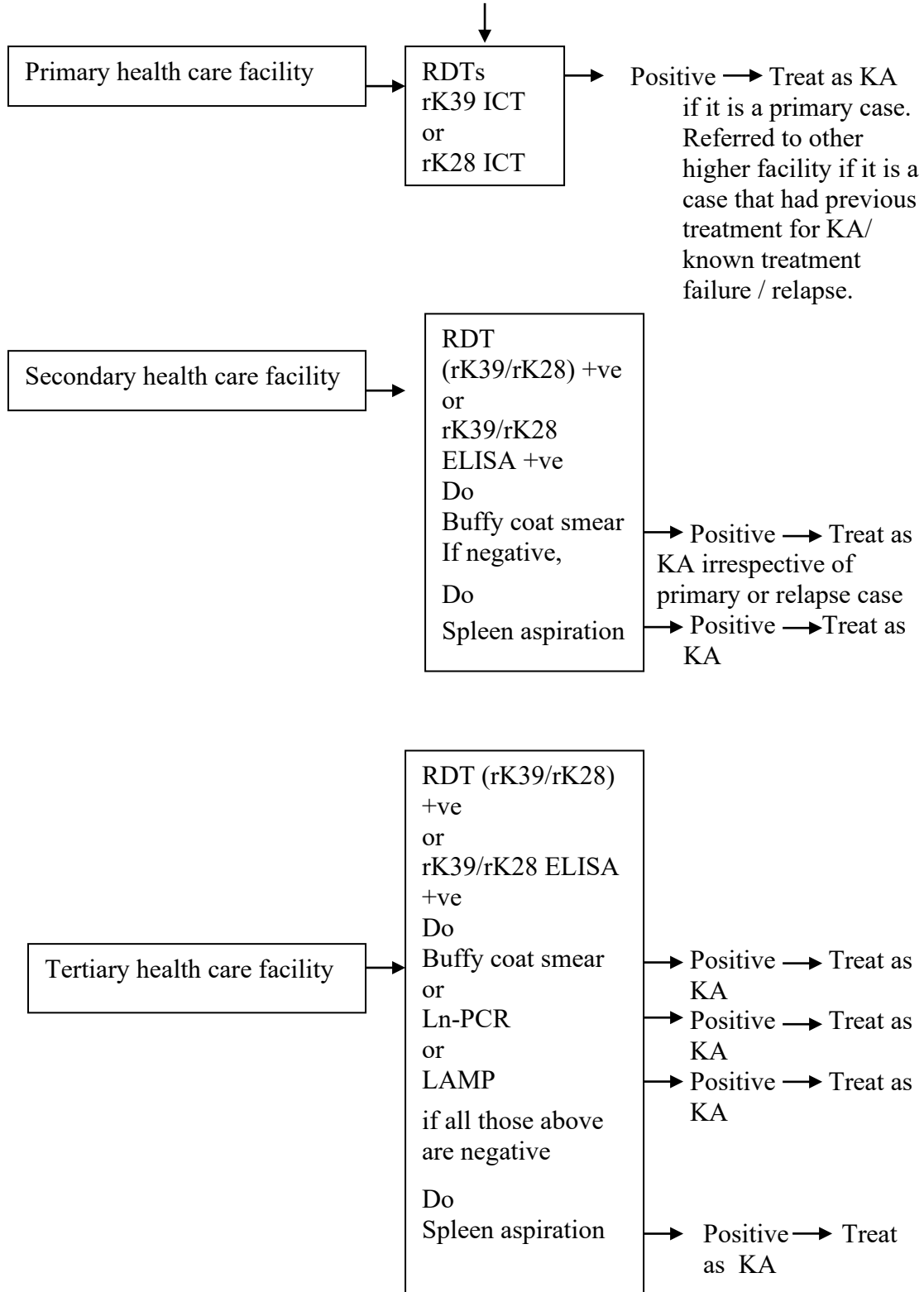

Notes:

- (i) **RDTs:** Both rK39 and rK28 ICT were found 99% sensitive for detection of kala-azar (KA), so any one of these ICTs can be performed for diagnosis at primary health care facilities including field among clinically suspected kala-azar patients those who fulfill the clinical case definition. But in case of history of previous treatment of KA, treatment failure or relapse, diagnosis of active KA should be confirmed by other tests. RDTs have many advantages like low cost, rapid, minimally invasive, virtual risk-free, user-friendly, can be done and interpreted easily even by paramedics/field workers, can be preserved at room temperature etc. The limitations include lack of discriminatory power between active VL and past or asymptomatic endemic healthy persons and it can not be used as tool for therapeutic response. Although sensitivities of both ICTs were excellent but specificity of 96% and 90% were noted for rK39 and rK28 respectively, so its interpretation should be made very carefully among individuals without cardinal symptoms for VL. rK39 ICT has been consistently found highly sensitive in the Indian subcontinent but there is insufficient data about rK28.
- (ii) **ELISA:** Both rK39 and rK28 ELISA were found 98% sensitive, so if facility permits (usually available at secondary or tertiary health care facilities) any one these ELISA can be done for clinical KA suspect if presents for the first time. Again, like any other serological test, it lacks discriminatory power between active VL and past or asymptomatic endemic healthy persons and can not be used as tool for therapeutic response. So, ELISA is also indicated only for patients who fulfill the clinical case definition. Although sensitivities of both ELISA were excellent but specificity of 97% and 94% were noted for rK39 and rK28 ELISA respectively, so its interpretation should be made carefully among asymptomatic

apparently healthy individuals. ELISA is machine dependable, technically demanding, relatively costly and requires electricity and skilled manpower, so unless modified as field version the present form is not suitable for point-of-care diagnostic test.

- (iii) **Buffy coat smear:** Diagnostic sensitivity of buffy coat smear microscopy was 93%, which is very encouraging for a minimally invasive parasitological tool. Buffy coat smear performed head to head with spleen smear having higher (3+ and above) parasite load. So, it is considered as an optimistic alternative to more invasive and potentially dangerous conventional parasitological methods like spleen or bone-marrow aspirations. Its excellent specificity of 100% among different types of controls has given it a unique and dependable status to screen asymptomatic VL subjects. It is minimally invasive, virtually risk-free and cost-effective confirmatory diagnostic tool for VL. Although there are insufficient data and practice of this tool but the very nature of the test states that with adequate training, skilled manpower can be developed to translate its use in the primary and of course in the secondary health care facilities in our country like that of TB or Malaria microscopy.
- (iv) **PCR:** Among different PCR-based diagnostic tools, Ln-PCR was found to have very good (94%) diagnostic sensitivity and excellent (99%) specificity. As a minimally invasive tool with reportedly high diagnostic yield, Ln-PCR can be used as alternative to parasitological diagnosis to confirm VL patient. But its cost, highly technical nature, skilled manpower and feasibility only in the tertiary or research facility are currently all limiting factors. Ln-PCR can be done for diagnostic, prognostic and genotyping purposes of kala-azar.
- (v) **LAMP:** Loop-mediated isothermal amplification using buffy coat as sample to detect leishmania DNA was found to be 89% sensitive and 100% specific. It is indeed very optimistic diagnostic indices for a

molecular tool that works at isothermal condition and result can be visualized in the naked eye avoiding the costly thermal cycler of conventional PCR and gel detection system. The simplicity, low cost and less technical demand of LAMP over conventional PCR-based methods have raised its future potential to be used as point-of-care test.

- (vi) **Spleen aspiration:** Although the specificity is high, the sensitivity of spleen smear microscopy varies from 93–99%. Moreover, the accuracy of microscopic examination is influenced by the parasite load, expertise of the microscopist and the quality of the reagents. Further, spleen aspiration can be complicated by life threatening haemorrhage in about 0.1% of individuals and therefore requires strict precautions, haematological screening, training and technical expertise, as well as facilities for nursing surveillance, blood transfusion and surgery. Spleen aspiration should be performed only by experienced medical personnel and if facilities to treat bleeding complications are available.

4.16 *Leishmania* genotyping results

Genotyping of the *Leishmania* detected from kala-azar patients in the present study was done by restriction fragment length polymorphism (RFLP) of ITS1 PCR amplified DNA products digested with *Hae*III restriction endonuclease. The restriction bands produced from VL patients all corresponded with the bands of *L. donovani* reference strain (Fig. 4.26) and thus proved to be all *L. donovani* for their genotype.

DNA sequence analysis of ITS1 and ITS2 products of 4 strains from the present study (Raj 21, Raj 64, Raj 68 and Raj 85) revealed all identical and corresponds to genotype H like that of other *L. donovani* from Bangladesh as seen in the neighbour joining tree (Fig. 4.27). Table 4.19 shows the taxonomical status of *Leishmania* strains detected in this study and their comparison with reference strains. All Bangladeshi strains including 4 from the present study

(Raj 21, Raj 64, Raj 68 and Raj 85) belong to genotype H exactly similar to strain ID, DON 39, with Zymodeme MON-2, isolated from VL patient from India (gene accession No. AJ634376). Therefore, all *Leishmania donovani* strains found in this study belonged to same genotype H like that of other strains from Bangladesh and India. Further, microsatellite repeat numbers of both ITS1 and ITS2 of strains of the *L. donovani* detected in this study were exactly similar to all other Bangladeshi strains (Table 4.20).

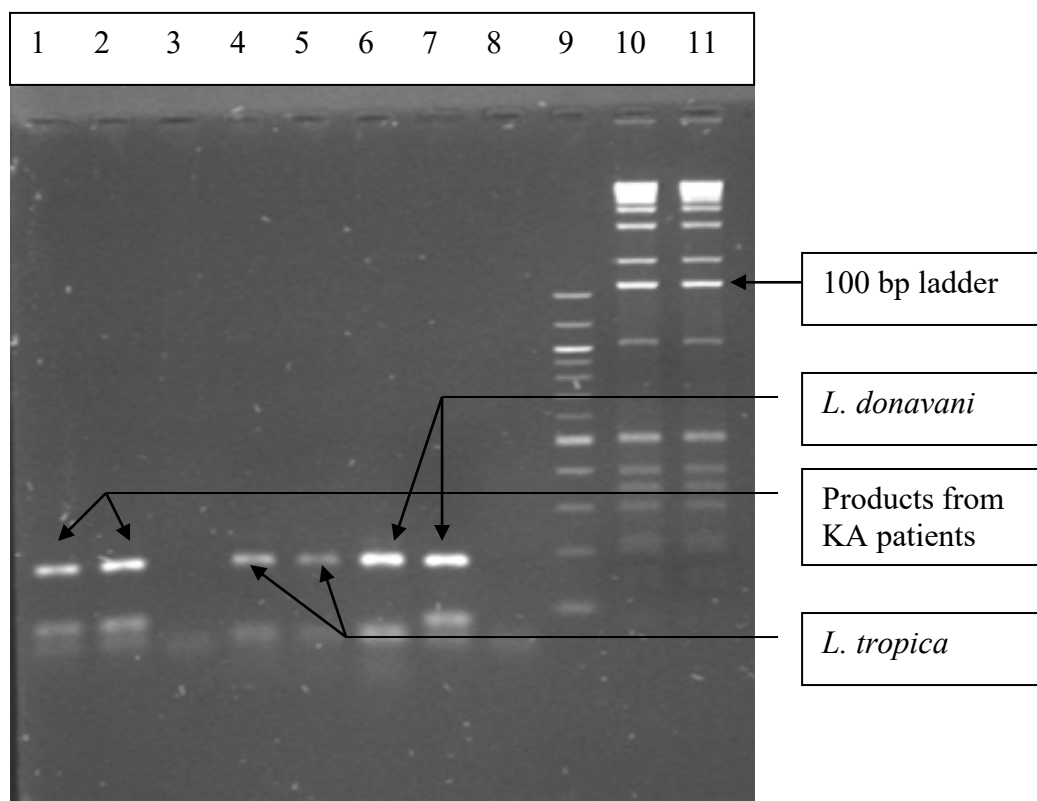

Fig. 4.26 ITS1-RFLP genotyping

Lane 1 and 2= ITS1 products from kala-azar patients, matched with reference strains of *L. donovani*. Lane 3 and 8= Negative controls, Lane 4 and 5= Reference strain of *L. tropica*, Lane 6 and 7= Reference strain of *L. donovani*, Lane 9= 123 bp molecular size marker, Lane 10 and 11= 100 bp ladder.

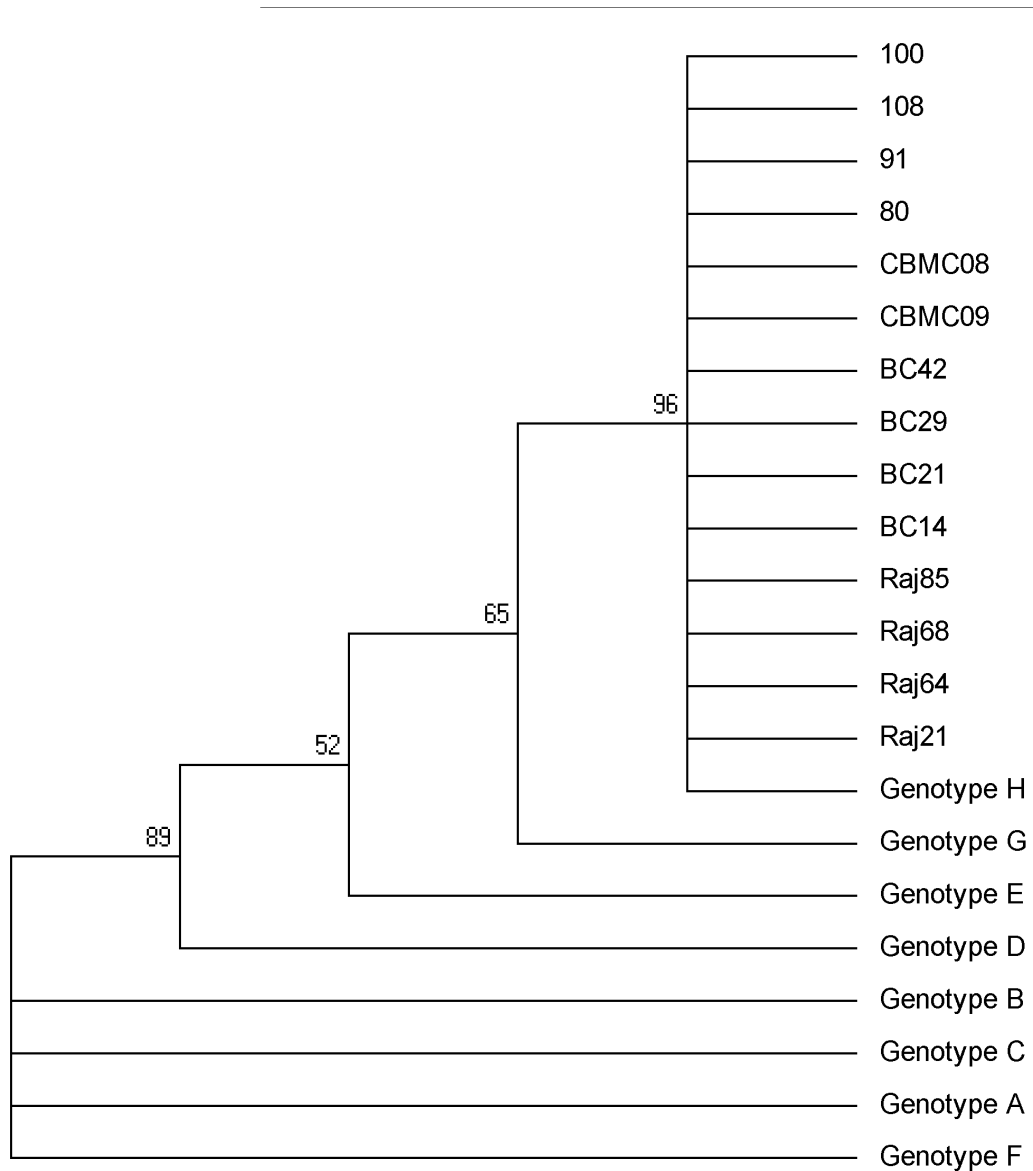

Fig. 4.27 Phylogenetic relationships among strains of the *L. donovani* complex inferred by parsimony analysis of the nucleotide sequences of the ITS1 and ITS2 regions. Sequence variation is based only on microsatellite polymorphisms. The numbers above the branches indicate the percentages with which a given branch is supported in 1000 bootstrap replications.

Table 4.19 Phylogenetic status of strains detected in this study and comparison with reference strains

Taxa	Strain ID	Country	Zymodyme	Pathology	ITS Seq. Type	Accession No.
<i>L. donovani</i>	Raj 85	Bangladesh	n.d.	VL	H	n.a.
<i>L. donovani</i>	Raj 68	Bangladesh	n.d.	VL	H	n.a.
<i>L. donovani</i>	BC 42	Bangladesh	n.d.	VL	H	n.a.
<i>L. donovani</i>	BC 21	Bangladesh	n.d.	VL	H	n.a.
<i>L. donovani</i>	CBMC 09	Bangladesh	n.d.	VL	H	n.a.
<i>L. donovani</i>	BC 029	Bangladesh	n.d.	VL	H	n.a.
<i>L. donovani</i>	108	Bangladesh	n.d.	VL	H	n.a.
<i>L. donovani</i>	91	Bangladesh	n.d.	VL	H	n.a.
<i>L. donovani</i>	100	Bangladesh	n.d.	VL	H	n.a.
<i>L. donovani</i>	80	Bangladesh	n.d.	VL	H	n.a.
<i>L. donovani</i>	CBMC 08	Bangladesh	n.d.	VL	H	n.a.
<i>L. donovani</i>	BC 14	Bangladesh	n.d.	VL	H	n.a.
<i>L. donovani</i>	Raj 64	Bangladesh	n.d.	VL	H	n.a.
<i>L. donovani</i>	Raj 21	Bangladesh	n.d.	VL	H	n.a.
<i>L. infantum</i>	INF-01	Tunisia	MON-1	VL	A	AJ000289
<i>L. infantum</i>	INF-03	France	n.d.	VL	B	AJ000288
<i>L. donovani</i>	DON-11	China	MON-35	VL	C	AJ000294
<i>L. donovani</i>	DON-49	Sudan	MON-276	Can VL	D	AJ634356
<i>L. infantum</i>	INF-60	Sudan	MON-30	VL	E	AJ634362
<i>L. donovani</i>	DON-24	Ethiopia	MON-18	VL	F	AJ634373
<i>L. donovani</i>	DON-03	Kenya	n.d.	PKDL	G	AJ000296
<i>L. donovani</i>	DON-39	India	MON-2	VL	H	AJ634376

N.B. n.d.- not done, n.a.- not available, Can-Canine

Table 4.20 Microsatellite repeat numbers of strains of the *L. donovani* detected in this study and comparison with other strains from Bangladesh

Strain ID	Seq. type	ITS1 Poly	ITS1 Poly	ITS1 Poly	ITS1 Poly	ITS2 Poly	ITS2 Poly	ITS2 Poly	ITS2 Poly	ITS2 Poly	ITS2 Poly	ITS2 Poly	ITS2 Poly
		(C)	(A)	(TA)	(A)	(AT)	(TA)	(G)	(G)	(TGG)	(GT)	(AT)	(C)
Raj 85	H	2	8	5	7	7	5	2+T+2	6	1	6	5	6
Raj 68	H	2	8	5	7	7	5	2+T+2	6	1	6	5	6
BC 42	H	2	8	5	7	7	5	2+T+2	6	1	6	5	6
BC 21	H	2	8	5	7	7	5	2+T+2	6	1	6	5	6
CBMC09	H	2	8	5	7	7	5	2+T+2	6	1	6	5	6
BC 029	H	2	8	5	7	7	5	2+T+2	6	1	6	5	6
108	H	2	8	5	7	7	5	2+T+2	6	1	6	5	6
91	H	2	8	5	7	7	5	2+T+2	6	1	6	5	6
100	H	2	8	5	7	7	5	2+T+2	6	1	6	5	6
80	H	2	8	5	7	7	5	2+T+2	6	1	6	5	6
CBMC 08	H	2	8	5	7	7	5	2+T+2	6	1	6	5	6
BC14	H	2	8	5	7	7	5	2+T+2	6	1	6	5	6
Raj 64	H	2	8	5	7	7	5	2+T+2	6	1	6	5	6
Raj 21	H	2	8	5	7	7	5	2+T+2	6	1	6	5	6

Chapter 5

DISCUSSION

5.1 Discussion

Until the beginning of the 1990s, the biological diagnosis of leishmaniasis relied on classical microbiological methods like microscopy on the stained smears prepared from spleen aspirates or bone-marrow, in-vitro cultivation on modified blood-agar or axenic media and conventional serological tests like Aldehyde test. The variable sensitivity of smear and requirement of hospitalization or low sensitivity of culture technique particularly in detecting the occult and sub-clinical infections has been considered as important limiting factors in conventional procedures. Consequently there is always a need for improved diagnostic tools which will be accurate, simple and cheap to be used in the remote endemic areas of kala-azar as point-of-care test.

The present study evaluated diagnostic performances of tools encompassing parasitological (buffy coat smear microscopy), PCR-based molecular diagnostics using buffy coat as sample (Ln-PCR, Mini-exon PCR, ITS1 and ITS2 PCR), Loop-mediated isothermal amplification (LAMP) for detection of DNA in buffy coat and serodiagnostic tools (both RDT and ELISA) against two recombinant antigens viz. rK39 and rK28 for all study population (both patients and controls). Diagnostic sensitivity of each tool was calculated against spleen-smear positive kala-azar patient (confirmed kala-azar), which is currently the gold standard for diagnosis.

Socio-demographical profile and clinical characters of 100 kala-azar patients were recorded. There were 68% male and 32% female with male to female ratio of 2.13:1. Kala-azar affects more male than female has also been revealed in our previous reports and findings of other investigators are in good agreement in favour of male preponderance (Chowdhury *et al.*, 1993a; Salam *et al.*, 2003, 2008, 2010). In our social custom, it is expected that males are more exposed to the environment suitable for the transmission of kala-azar because of their nature of work. Moreover, in our cultural settings, males remain more physically exposed i.e. use less clothing than females as a result there is increase chance of biting by infected sandfly.

Age of KA patient's ranged from 1 to 60 years with mean of 20.66 ± 15.863 years. Although no age is immune but it has been found consistently that young people are more vulnerable affecting by kala-azar. Previous reports are in good agreement regarding age of kala-azar patients (Alam *et al.*, 1996; Bora, 1999; Salam *et al.*, 2003). The reasons for the higher prevalence of kala-azar among comparatively younger age groups remain to be explored. But it is speculated that those people are more in their active life and as a consequence there is also more chance to be exposed to the environment favorable for kala-azar transmission.

Regarding socioeconomic status of kala-azar patients, it has been observed that, monthly income of patient or their guardian ranged from Tk. 2500 to 15000 with mean Tk. 4005 ± 2631.871 . Kala-azar has been regarded as a disease prevailing among poorest of the poor and socially marginalized people in endemic countries including Bangladesh (Bora, 1999; Bern and Chowdhury, 2006; Boelaert *et al.*, 2009). There are so many reasons that poor and rural people are the victims of kala-azar. Firstly, the vector sandfly resides inside the cracks and crevices of mud houses frequently seen in the rural areas where kala-azar is endemic. Secondly, overcrowding, ill ventilation and accumulation of organic matters in the environment which facilitate the breeding and transmission of vector are also seen among these housing conditions. Thirdly, occupation of the

poor and rural underprivileged people like farming, forestry, mining and fishing pose a greater risk of being bitten by sandflies.

Duration of fever among KA patients ranged from 4 to 52 weeks with mean duration of 20.61 ± 12.518 weeks. Ninety eight percent (98%) of KA patients had splenomegaly ranged from just palpable to up to 12 cm from costal margin along the left mid-clavicular line, while 76% had concomitant palpable liver. Anaemia, mild and moderate body wasting, blackening of skin and weight loss are clinical manifestations and very prototypical for Indian kala-azar which are considered as important features for clinical case definition of kala-azar by several authorities (Chowdhury *et al.*, 1990; Rahman *et al.*, 2008). As far as the kala-azar patient's characteristics are concerned, all these features were consistently noted and reported in all previous publications (Salam *et al.*, 2003, 2009, 2010, 2011 & 2012), which were shared and observed well by other researchers from this subcontinent too (Sanyal, 1985; Chowdhury *et al.*, 1990; Chowdhury *et al.*, 1993b).

In the present study, 18% patients had history of kala-azar among member(s) of their family and 13% had suffered from previous attack of kala-azar. Kala-azar is an endemic parasitic disease that tends to occur among family members and there is clustering as noted by many authors (Desjeux, 2001; Bern *et al.*, 2005), so, our findings of 18% patients had family history of KA are consistent with those reports. Also immunity in kala-azar is a matter of long controversy because whether immune response develops for protection or pathogenesis is not yet clear (Saha *et al.*, 2006), as a consequence re-infection or relapse is noted among many sufferers and 13% of our patients have had history of previous attack can be well correlated with this statement. As rare clinical presentations, 2% of patients presented with jaundice and 9% complained of bleeding manifestation during diagnosis. Although rare but atypical presentations like bleeding or jaundice in kala-azar have also been reported by others (Sarker *et al.*, 2003a; Salma *et al.*, 2012), so these findings are well recognized in kala-azar patients.

Rapid diagnostic test (RDT) was performed against two recombinant antigens, K39 and K28. In the present study, rK39 showed excellent sensitivity of 99% (95% CI= 93.75-99.94%), specificity of 96% (95% CI= 89.84-98.71%) and diagnostic accuracy of 95% (95% CI= 90.67-99.33%) respectively. For rK39, this performance is not new because most of the studies carried out in the Indian subcontinent (Bangladesh, India and Nepal) reported its sensitivity around 100% (Sundar *et al.*, 1998; Bern *et al.*, 2000; Sarker *et al.*, 2003b; Ritmeijer *et al.*, 2006; Salam, 2008). In a comparative evaluation of parasitology and serological tests in the diagnosis of visceral leishmaniasis in India (a phase III diagnostic accuracy study), sensitivity and specificity of rK39 RDT were found to be 98.9% and 97% respectively (Sundar *et al.*, 2007). Present findings are exactly the same with this recent large Indian study. As far as the specificity of rK39 ICT is concerned, it showed 100% specificity among non-endemic and disease controls but decreased specificity was observed among endemic healthy controls, which are also in accordance with the phase III diagnostic accuracy study of India. Clinically visceral leishmaniasis is suspected in only a fraction of infected persons in an endemic area and many of them may not have clinical manifestations for long period and remain asymptomatic (Singh *et al.*, 2002). Those asymptomatic but apparently healthy persons become sero positive and 4 persons out of 30 endemic controls those who were found positive for rK39 ICT can be asymptomatic but apparently healthy persons in our series. So, it is very important to correlate the sero-positivity of rK39 with clinical case definition of kala-azar (Rahman *et al.*, 2008) for introduction of treatment especially in the Indian subcontinent. In the proposed diagnostic algorithm, this point has been emphasized that in order to consider active kala-azar based on positive RDT, the patient must fulfill the clinical case definition. However, this test shows a regional variation and has been shown to be less accurate in East Africa (Boelaert *et al.*, 2008). A few studies from Sudan reported its decreased sensitivity ranged from 67% to 71% (Jelinek *et al.*, 1999; Zijlstra *et al.*, 2001), so this form of RDT is not practiced in those endemic areas for VL diagnosis. For reasons that remain unclear, Sudanese patients seem to develop lower titres of

antibodies against K39 antigen than patients of Indian subcontinent (Boelaert *et al.*, 2008).

A meta-analysis including 13 validation studies of the rK39 ICT showed its sensitivity and specificity estimates of 93.9% (95% CI= 87.7-97.1%) and 95.3% (95% CI= 88.8-98.1%), respectively (Chappuis *et al.*, 2006). In another recent meta-analysis using 14 studies from different geographical areas of VL endemicity those who fulfilled the Cochrane recommendations to compare the sensitivity and specificity of serodiagnostic tests using rK39 antigen, the sensitivity and specificity of rK39 RDT was found to be 94% and 89% respectively (Maia *et al.*, 2012). Within these reports, significant discrepancies in sensitivity and specificity were found, which were likely due to a multitude of reasons including variability in testing methods, different geographic regions, different sources for the tests and lack of homogeneity of the studied population. But several studies since its introduction of rK39 RDT have shown that, Indian VL is associated with high titres of circulating anti-K39 antibody and particularly well suited for serodiagnosis by strip testing in this subcontinent (Singh *et al.*, 1995).

Considering the reportedly very high diagnostic sensitivity found in several studies in the Indian subcontinent and many unique features like easy to perform, rapid, cheap and reproducibility of results, rK39 ICT has been accepted as the best option for serodiagnosis of kala-azar in the Indian subcontinent including Bangladesh. For the same reason, it is being logically used as diagnostic tool for VL elimination programme of these three countries.

rK39 ELISA was performed for all of present study population to evaluate its diagnostic indices in comparison to the gold standard. The sensitivity, specificity and diagnostic accuracy of rK39 ELISA were found to be 98% (95% CI= 92.26-99.65%), 97% (95% CI= 90.84-99.22%) and 95% (95% CI= 90.67-99.33%) respectively. For ELISA, 1 of 30 endemic controls and 2 of 40 disease controls were found positive at a cut off OD of 2.3935 and all non-endemic controls were negative. Diagnostic sensitivity and specificity of rK39 ELISA were found to be

98.21% and 95.65% respectively in previous published report (Salam *et al.*, 2009) and the present results are in good agreement with that. In many Indian studies similar diagnostic indices of rK39 ELISA have been reported by investigators (Kumar *et al.*, 2001; Kurkjian *et al.*, 2005). Sensitivity of ELISA in the diagnosis of VL depends on the antigen used and rK39 antigen has been found to be more specific than crude soluble antigen (CSA). Excellent sensitivity of ELISA in our study could well be correlated with the fact that we used K39 antigen. Although ELISA is a very popular and essential diagnostic tool not only for kala-azar but for most of the infectious diseases with high diagnostic accuracy, but requirement of costly machine, reagents, incubator, electricity and trained personnel are all the limiting factors for its poor adaptability in the field conditions of kala-azar endemic areas. Considering many folds ease of rK39 ICT and comparable diagnostic performances, ELISA can reasonably be replaced by RDT for serodiagnosis of kala-azar. However, the superiority of ELISA over RDT relies on its potential for use in predicting response to chemotherapy because the antibody titre correlates directly with the disease activity. It has been shown that anti-rK39 antibody titres were 59 fold higher than those of antibody against CSA at the time of diagnosis and with successful therapy, it fell sharply at the end of treatment and fell further during follow-up monitoring. In patients who experience disease relapse, the titre rose steeply again (Kumar *et al.*, 2001). Further, the diagnostic and prognostic utility of rK39 ELISA for VL-HIV co-infections has also been demonstrated (Houghton *et al.*, 1998).

Towards further advancement of serodiagnosis, rK28 antigen has been recently introduced as a candidate for diagnosis of VL. In the present study evaluation was done on the diagnostic performance of this new recombinant antigen for VL which has not been commercialized yet. The sensitivity, specificity and diagnostic accuracy of rK28 ICT was found to be 99% (95% CI= 93.75-99.94%), 90% (95% CI= 81.96-94.83%) and 89% (95% CI= 82.68-95.32%) respectively. Specificity of rK28 was significantly jeopardized among endemic controls (30% of endemic controls had positive rK28 ICT) and 1 of 30 non-endemic controls (3.33%) also showed positive rK28.

There has been only a single multi-centered study of rK28 RDT incorporating 53 VL patients and 40 healthy controls from Bangladesh to evaluate a lateral flow-based rK28 rapid test which reported high 98.1% (95% CI= 89.93-99.95%) sensitivity and 92.5% (95% CI= 87.7-97.2%) specificity (Pattabhi *et al.*, 2010). As far as the diagnostic sensitivity of this new RDT is concerned, our results are comparable to this study. The same study also included the rK28-DPP (Dual Path Platform) RDT to compare its performance with rK39 among 73 VL patients and 62 controls from Sudan, which proved to be superior over rK39 with 95.9% (95% CI= 88.46-99.1%) sensitivity and 100% specificity (Pattabhi *et al.*, 2010). Although the diagnostic sensitivity of rK28 ICT is equally comparable with rK39 ICT among VL patients but its specificity decreased significantly among endemic controls (30% vs. 13.33%), so this limitation should be considered for its future commercialization as rapid serodiagnosis tool.

Serodiagnostic tools in the present study also included rK28 ELISA carried out for all of study population and its diagnostic sensitivity, specificity and accuracy were found as 98% (95% CI= 92.26-99.65%), 94% (95% CI= 86.88-97.53%) and 92% (95% CI= 86.57-97.43%) respectively. Specificity of rK28 ELISA among endemic and disease controls was 90% (95% CI= 81.96-94.83%) and 92.5% (95% CI= 87.7-97.2%) respectively. In a recent Indian study (Vaish *et al.*, 2012), sensitivity and specificity of rK28 antigen in a micro-ELISA format was conducted on 252 parasitologically confirmed VL cases, 103 endemic healthy controls, 95 non endemic healthy controls, 88 other infectious disease and 53 follow-up cases. Of 252 parasitologically confirmed VL cases, 251 cases were found positive by rK28 antigen yielding 99.6% sensitivity (95% CI= 97-99%). Specificity of rK28 antigen in non-endemic and endemic healthy controls was 100% (95% CI= 96-100%) and 94.17% (95% CI= 88-97%), respectively, while for 88 different diseases, specificity was 95.45% (95% CI= 84-96%). Results of rK28 ELISA observed in the present study are comparable with this recent Indian study. So far there has been no report on rK28 ELISA from Bangladesh and only a few reports are available

worldwide, so there is very limited scope to compare and contrast our results. Considering the same advantages as mentioned for rK39 RDT over ELISA, it is equally applicable that rK28 ELISA can reasonably be replaced by RDT as Spearman correlation of different serodiagnostic tools was found to be highly significant ($P=0.0001$).

In buffy coat smear microscopy, the diagnostic sensitivity, specificity and accuracy of this minimally invasive parasitological tool were found to be 93% (95% CI= 85.62-96.89%), 100% (95% CI= 95.38-100%) and 93% (95% CI= 87.91-98.09%) respectively, which are exactly comparable and reproducible with a recent published preliminary report on this promising tool (Salam *et al.*, 2012). Shamsuzzaman *et al.* (2007) also reported the same detection rate of 92.98% by buffy coat smear microscopy among confirmed VL patients in a study conducted in Mymensingh, Bangladesh. Present findings are very much consistent with this study because of similar technique used for buffy coat separation (separated by density gradient centrifugation technique) and selection of confirmed VL patients. There was another study conducted in Bangladesh to investigate the diagnostic sensitivity and specificity of buffy coat smear for VL, which found a positivity rate of only 31% among 67 clinically suspected VL patients (Roy *et al.*, 2009). Unfortunately the results of present study cannot be compared with the results of Roy *et al.* (2009) because they did not report the buffy coat smear positivity rate among confirmed VL cases (44/67) and also among those who had been positive by rK39 rapid test (57/67). Nevertheless, the low positivity rate for buffy coat smear found by them might be due to the conventional method (without use of density gradient centrifugation technique by Histopaque solution) for buffy coat preparation.

Parasite load in spleen smears of kala-azar patients was graded from 1+ to 6+ according to Chulay and Bryceson (1983) and performances of buffy coat smear and different molecular tools were compared against different grades of parasite load. It was noted that buffy coat smear positivity was directly

proportional to higher parasite load as buffy coat smear was found 100% positive among patients having $\geq 3+$ grade of parasite load ($P < 0.0001$) as opposed to grade 1+ and 2+. On the contrary, there was no significant correlation between parasite load and positivity of molecular tools. This is quite logical that increasing parasitic load eventually leads to a greater chance of its detection in buffy coat that contains monocyte concentrate harboring the parasites.

Diagnostic specificity of buffy coat smear was found to be excellent (100%) and this is very important for a diagnostic tool to discriminate between symptomatic and asymptomatic VL cases. A few studies documented that the buffy coat smear should be a good diagnostic method for active VL, since parasitemia among asymptomatic VL patients and healthy controls from areas of endemicity was very low (0% to 1.3%) (Sharma *et al.*, 2000).

The idea for diagnosis of VL using peripheral blood buffy coat smears originated from studies in the early 1990s (Martínez *et al.*, 1993; López-Vélez *et al.*, 1995). These studies showed that the *Leishmania* parasite could be demonstrated by microscopy of peripheral blood smears of HIV infected patients with visceral leishmaniasis. *Leishmania* amastigotes in peripheral blood specimens from Indian kala-azar patients were also demonstrated later, with a rate of 46% to 66% depending on the time of blood sampling (Saran *et al.*, 1997). The development of an accurate, practical and affordable diagnostic test is essential for any attempt to control VL in areas of endemicity. The conventional methods of parasite demonstration are not only associated with painful invasive procedures but may be fatal in rare case of spleen aspiration. Moreover, common haematological laboratory evaluation of the patient is a prerequisite for conventional invasive procedures, which are not feasible to be performed at the point of care in regions where VL is endemic. Therefore, an alternative method for parasitological diagnosis of VL with minimum

invasiveness and risk for the patients is essential. The high sensitivity and excellent specificity of buffy coat smear for diagnosis of VL found in the present study and a few more studies in Bangladesh has encouraged us to recommend this parasitological tool as a promising alternative for more invasive conventional tools. Unique features of this parasitological diagnosis for VL include minimal invasiveness, affordable, virtually risk-free with a definite potential to be used as point-of-care test in endemic areas of Bangladesh. Currently there is no facility available for confirmatory diagnosis of VL in the sub-district hospitals of Bangladesh, so buffy coat smear can be used as a confirmatory diagnostic tool in these health facilities.

The present study is the first of its kind in our country where four PCR methods viz. Ln-PCR, Mini-exon, ITS1 and ITS2 have been compared simultaneously for their diagnostic value in VL. Buffy coat was used as a sample for parasite DNA detection, thus circumventing the need of more invasive procedure. The results indicate that of the existing molecular methods, Ln-PCR should be the preferred choice for the diagnosis of VL because of its high diagnostic sensitivity followed by Mini-exon and ITS. Further, the study has demonstrated that all PCR methods had excellent specificity, which can be used for discriminating symptomatic and asymptomatic cases.

The *SSU-rRNA* region has been extensively targeted for nested PCR amplification in VL. Nested PCR is an improved version where a second set of *Leishmania*-specific primers was used to amplify the first PCR products. An advantage of this Ln-PCR is its high degree of sensitivity where in theory, 0.01 promastigote from a *Leishmania* culture can be detected (Cruz *et al.*, 2002). The high sensitivity of 94% (95% CI= 86.88-97.53%) and excellent specificity of 99% (95% CI= 93.75-99.94%) were observed for Ln-PCR among confirmed kala-azar patients in the present study. These findings are concordant with some previous published reports on Ln-PCR (Lachaud *et al.*, 2001; Antinori *et al.*, 2007; Alam *et al.*, 2009c; Salam *et al.*, 2010). However, low sensitivity has

also been reported by some authors (Osman *et al.*, 1997; Cruz *et al.*, 2006), which can be attributed to the inappropriate sample volume of 1.5 μ L of blood used in filter paper (Osman *et al.*, 1997) and also due to meager sample volume (100 μ L) used for extraction of DNA from blood (Cruz *et al.*, 2006). Further, low parasite load could also be a reason for less sensitivity of PCR method as found for some cases in previous attempt for Ln-PCR (Salam *et al.*, 2010). Le Fichoux *et al.* (1999) demonstrated that temporary absence of parasites from the blood of kala-azar patients could also be considered for some Ln-PCR negative cases among confirmed VL patients (Le Fichoux *et al.*, 1999). None of the subjects from disease controls and non-endemic controls was found positive by Ln-PCR method, indicating its excellent specificity. Although sophisticated machines, trained personnel and cost are limiting factors for PCR as a routine diagnostic test for kala-azar especially in endemic areas but results of the present study and many previous studies clearly showed that Ln-PCR using buffy coat as sample has got very high diagnostic sensitivity. So, reasonably in its permissive settings, Ln-PCR could be an appropriate substitute for more invasive procedures like splenic or bone marrow aspirations.

For its inherent unique biological features, the Mini-exon gene has become a potential target for molecular diagnosis of VL. We utilized this target gene for PCR amplification again for the first time in our country to assess its diagnostic value for VL. Sensitivity and specificity of Mini-exon PCR were found to be 86% (95% CI= 77.28-91.85%) and 100% (95% CI= 95.38-100%) respectively, which corroborate with previous report (Marfurt *et al.*, 2003). Negative results of Mini-exon PCR against confirmed VL cases could be due to the fact that circulating parasites do not remain elevated during the complete course of disease as reported by a few investigators (Saran *et al.*, 1997; Fisa *et al.*, 2002). Katakura *et al.* (1998) reported sensitivities of Mini-exon PCR from bone marrow and buffy coat samples as 75% and 58% respectively in a study done in China (Katakura *et al.*, 1998). These comparatively low sensitivities could

be due to different species of *Leishmania* prevalent in China than Indian subcontinent.

PCR amplification of ITS1 and ITS2 sequences were also carried out using buffy coat sample for VL diagnosis in the present study. When compared with the gold standard, sensitivity of ITS1 and ITS2 as 85% (95% CI= 76.14-91.08%) and 80% (95% CI= 70.56-87.07%) respectively with 100% specificity for both targets were found. The results are concordant with other published reports on ITS1 for diagnosis of VL from bone marrow and blood (Alam *et al.*, 2009b; Roelfsema *et al.*, 2011). The negative results (15% for ITS1 and 20% for ITS2) obtained against the parasitologically confirmed VL cases may be due to the presence of residual amounts of haemoglobin or heparin, which is reported to be inhibitors of *Taq* polymerase (Andresen *et al.*, 1997). Also it has been reported that diurnal variation seems to play a role in PCR positivity (Saran *et al.*, 1997). According to some published reports, another reason for decreasing sensitivity may be due to low parasite number in a few cases where ITS PCR becomes unable to detect DNA (Schonian *et al.*, 2003; Bensoussan *et al.*, 2006).

In this study, we have validated the LAMP assay developed by Takagi *et al.* (2009) with 100 confirmed VL cases and 100 controls. It has revealed very encouraging sensitivity of 89% (95% CI= 80.77-94.11%) and 100% specificity, compared to spleen smear positive kala-azar cases. The diagnostic sensitivity and specificity of LAMP in this study are in good agreement with a recent published report where sensitivity of 90.7% (95% CI= 95.84-81.14%), and a specificity of 100% (95% CI= 100-95.43%) were observed (Khan *et al.*, 2012). In a study conducted by Takagi *et al.* (2009), diagnostic sensitivity of LAMP was evaluated for 10 confirmed VL patients and 08 (80%) were found to be positive for parasite DNA (Takagi *et al.*, 2009). In another study conducted with 30 confirmed VL patients, LAMP was found to be 83% sensitive and 98% specific (Adams *et al.*, 2010). To compare the sensitivity and specificity of LAMP using buffy coat DNA in our study consisting of 100 confirmed VL cases and 100 controls, we found

a slightly higher sensitivity of 89% and specificity of 100%. This could be due to use of buffy coat as sample and large sample size. A similar range of sensitivity was reported by a number of investigators using either whole blood or buffy coat (PBMC) for PCR assays targeting the ITS or Mini-exon regions for DNA detection (Marfurt *et al.*, 2003; Alam *et al.*, 2009c).

The specificity of the LAMP assay has been shown to be very high as the assay utilizes four sets of primers targeting six distinct target DNA sequences (Nagamine *et al.*, 2002; Njiru *et al.*, 2008). In the present study, although LAMP has failed marginally to satisfy the WHO sensitivity level of >95% for any acceptable test there are still several advantageous aspects of the LAMP assay that need to be considered. The very exciting features of LAMP assay include requirement of just a heat block or even a simple water bath instead of a costly thermal cycler for conventional PCR. Moreover, the assay is performed under isothermal conditions at a temperature range of 60°-65°C, circumventing the time length involved in thermal changes of conventional PCR and also prevents or lowers inhibition observed in its later stages (Mori *et al.*, 2001). However, when the LAMP reaction is performed in a water bath the chances of contamination tends to increase more and hence it is recommended to wrap the cap of the tube with paraffin prior to performing the LAMP assay. Further, the requirement of electrical power supply to operate the water bath at the resource limited settings can be avoided by the usage of alternative power sources such as battery, exothermal chemicals and solar power. In addition, results of LAMP assay are interpreted by observing turbidity (Mori *et al.*, 2001; Lau *et al.*, 2011) that reduces cost and time of post conventional PCR analysis as well as eliminating the chance of contamination involved in agarose gel electrophoresis. It is also noted that gel electrophoresis involves handling of potent carcinogenic agents such as ethidium bromide which poses a potential threat for those handling it in the laboratory.

Several reports have indicated the usefulness of using heat-treated samples as a template DNA source for LAMP without compromising the sensitivity, and

thus eliminating the need for DNA extraction which reduces both time and cost (Enomoto *et al.*, 2005; Njiru *et al.*, 2008). We speculate that, validation of heat treated buffy coat as a DNA source could further minimize the cost for diagnosis if it can be established for visceral leishmaniasis.

All diagnostic tools in the present study performed good (80%) to excellent (99%) for their sensitivity and very good (90%) to excellent (100%) for their specificity in the diagnosis of kala-azar. Further, all tools correlated significantly ($P=0.0001$) in regards gold standard (spleen smear positive for LD body) as revealed by Spearman correlation. When diagnostic tools were compared pair-wise with spleen smear, significant ($P<0.05$) comparison was observed for rK28 ICT, Buffy coat smear, LAMP, Mini-exon, ITS1 and ITS2 PCR by McNemar pair test. Comparison of Ln-PCR with other PCR methods was also found significant ($P<0.05$). Receiver Operating Characteristics (ROC) analysis of diagnostic tools for their sensitivity and specificity revealed good area under curve (AUC) ranging from 0.900 to 0.965 at 95% CI for molecular tools against spleen smear. While AUC of serodiagnostic tools and buffy coat smear against gold standard in ROC analysis ranged from 0.945 to 0.975, which was also very good.

Performances of diagnostic tools were scored from 0 to 4 by Index (factor analysis in SPSS was used to construct indices) analysis taking consideration of their diagnostic accuracy (kappa value), cost, interpretation of test result, availability, user friendliness, test type and potential for field use. Based on Index score, diagnostic tools evaluated for kala-azar in the present study were ranked from 1 to 10.

Considering the ranking of diagnostic tools based on Index scoring, we have proposed a diagnostic algorithm for kala-azar in Bangladesh. In the proposed algorithm, for primary health care facility including field, rK39 or rK28 RDT is the best diagnostic test for clinically suspected cases that fulfill the clinical case definition of kala-azar. In a study for evaluating diagnostic tests for VL conducted at Nepal, authors opined that rK39 dipstick test could replace

parasitology as the basis of a decision to treat VL cases in the peripheral health services (Boelaert *et al.*, 2004), and findings of our study are in same agreement with that study. RDTs have many advantages like low cost, rapid, minimally invasive, virtual risk-free, user-friendly, can be done and interpreted easily even by paramedics/field workers, can be preserved at room temperature etc. The limitations include lack of discriminatory power between active VL and past or asymptomatic endemic healthy persons and it cannot be used as tool for therapeutic response. Although sensitivities of both ICTs were excellent (99%) but specificity of rK39 and rK28 (96% vs. 90%) varied, so its interpretation should be made very carefully among individuals without cardinal symptoms for VL. It is worth mentioning that rK39 ICT has been consistently found highly sensitive in the Indian subcontinent but there is insufficient data about rK28.

Asymptomatic, treatment failure, relapse or known cases of immunodeficiency with suspected kala-azar must be diagnosed by positive buffy coat smear (preferred) or spleen smear at the secondary care health facilities. Diagnostic sensitivity of buffy coat smear microscopy was 93%, which is very encouraging for a minimally invasive parasitological tool. So, it is considered as an optimistic alternative to more invasive and potentially dangerous conventional parasitological methods like spleen or bone-marrow aspirations. Its excellent specificity of 100% among different types of controls has given it a unique and dependable status to screen asymptomatic VL subjects. It is minimally invasive, virtually risk-free and cost-effective confirmatory diagnostic tool for VL. Although there are insufficient data and practice of this tool but the very nature of the test states that with adequate training, skilled manpower can be developed to translate its use in the primary and of course in the secondary health care facilities in our country like that of TB or Malaria microscopy.

For, tertiary health care facilities or research centres, RDT or ELISA-positive cases should be confirmed either by positive buffy coat smear or spleen smear or Ln-PCR or LAMP according to the availability of tests. Ln-PCR can be used

as alternative to parasitological diagnosis to confirm VL patient due to its excellent sensitivity. But its cost, highly technical nature, skilled manpower and feasibility only in the tertiary or research facility are currently all limiting factors. Moreover, Ln-PCR can be done for diagnostic, prognostic and genotyping purposes of kala-azar. LAMP has been found to be very optimistic molecular diagnostic tool that works at isothermal condition and result can be visualized in the naked eye avoiding the costly thermal cyclers of conventional PCR and gel detection system. The simplicity, low cost and less technical demand of LAMP over conventional PCR-based methods have raised its future potential to be used as point-of-care test.

Although the specificity is high, the sensitivity of spleen smear microscopy varies from 93–99%. Moreover, the accuracy of microscopic examination is influenced by the parasite load, expertise of the microscopist and the quality of the reagents. Further, spleen aspiration can be complicated by life threatening haemorrhage in about 0.1% of individuals and therefore requires strict precautions, training and technical expertise, as well as facilities for nursing surveillance, blood transfusion and surgery. Spleen aspiration should be performed only by experienced medical personnel and if facilities to treat bleeding complications are available.

As far as the genotype of parasite is concerned, *Leishmania donovani* was found to be the sole causative agent for all patients from 10 endemic districts of greater Rajshahi as revealed by ITS1-RFLP analysis. Alam *et al.* (2009b) reported that there was genetic homogeneity of *Leishmania donovani* strains in the Indian subcontinent in their study incorporating strains from different endemic countries and our findings are truly consistent with that report. Analysis of genetic polymorphism of *L. donovani* through DNA sequencing of ITS1 and ITS2 PCR amplified products also revealed that all strains from present study were similar and there was no polymorphism. All 14 Bangladeshi strains including 4 from the present study (Raj 21, Raj 64, Raj 68 and Raj 85) belong to genotype H exactly similar to strain ID, DON 39, with Zymodeme

MON-2, isolated from VL patient from India (gene accession No. AJ634376). Therefore, all *Leishmania donovani* strains found in this study belong to same genotype H like that of other strains from Bangladesh and India. Further, microsatellite repeat numbers (both ITS1 and ITS2) of strains of the *L. donovani* detected in this study are exactly similar to all other Bangladeshi strains. This observation has reinforced the previously published genotyping reports by different investigators from both India and Bangladesh that the same strain of *L. donovani* causing kala-azar has been circulating and clonally propagated throughout the Indian subcontinent for centuries.

Most strains from the Indian subcontinent presented a very homogeneous population that included all strains previously typed as MON-2. The identification of a single cluster of genetically almost identical strains of *L. donovani* in the regions of Bangladesh, India and Nepal highly endemic for VL suggests that this population emerged only recently and underwent a very short evolutionary process since then. The most plausible explanation for the great genetic homogeneity of strains of *L. donovani* from these regions is a bottleneck event that exterminated the original *L. donovani* population(s) leaving only a small pocket of survivors. In the 1960s, kala-azar was virtually disappeared from the Indian subcontinent as a collateral effect of insecticide spraying under the Malaria Control Program. However, the completion of this campaign resulted in a dramatic resurgence of the disease in Bihar, India in the late 1970s (Sen Gupta, 1975) which then spread downstream to Bangladesh and to bordering regions in Nepal. However, it can not be ruled out that Indian *L. donovani*, being parasites of humans only, may have undergone a long process of adaptation to human physiology during which they have lost their intraspecies diversity as previously suggested (Pandey *et al.*, 2007).

5.2 Conclusion

Laboratory test always has definite place for confirmation of clinical diagnosis of diseases more so for kala-azar because of its variable clinical manifestations and sharing of host by other diseases. Present study is first of its kind in Bangladesh where diagnostic evaluation of new tools like rK28 antigen and buffy coat smear microscopy have been evaluated for 200 study population following recommended guidelines. Further, comparison of available laboratory tests encompassing parasitological (spleen and buffy coat smear), PCR-based molecular tools (Ln-PCR, Mini-exon, ITS1 and ITS2), LAMP and serodiagnostic methods against two recombinant antigens (rK28 and rK39) in both RDT and ELISA for kala-azar have also been done to formulate applicable diagnostic algorithm for kala-azar in Bangladesh. All diagnostic tests showed good to excellent sensitivity (80% to 99%) and specificity (90% to 100%) against confirmed kala-azar cases (spleen smear positive for LD body) and controls comprising endemic, non-endemic and disease controls. Comparison of different tools against spleen smear was also found to be significant at 95% CI ($P < 0.05$) for most of the tools.

Factor analysis in SPSS was used to construct indices of diagnostic tools, with 0 to 4 score. For Index analysis, diagnostic accuracy (kappa value), cost, interpretation of test result, availability, user friendliness, test type and potential for field use were considered. Based on Index score, diagnostic tools for kala-azar were ranked from 1 to 10. It was evident from indexing score that rK39 ICT was the best diagnostic option (Rank #1) followed by rK28 ICT (Rank #2), Buffy coat smear microscopy (Rank #3), rK39 ELISA (Rank #4), rK28 ELISA (Rank #5), Ln-PCR (Rank #6), LAMP (Rank #7), Mini-exon PCR (Rank #8) ITS1 PCR (Rank #9), and ITS2 PCR (Rank #10) for kala-azar.

In the diagnostic algorithm, RDT (rK39 or rK28) was proposed as most preferred diagnostic test for primary health care facilities including field for suspected patients who fulfill the clinical case definition of kala-azar due to its many unique features. Asymptomatic, treatment failure, relapse or

immunodeficient cases should be diagnosed by tests other than serology like buffy coat smear (preferred), Ln-PCR or LAMP or splenic aspiration at secondary or tertiary health care facilities. We are optimistic from present study results that conventional invasive parasitological diagnosis by splenic aspiration can be replaced by buffy coat smear by making it available in different levels of health care facilities in our country through development of trained microscopists like what has been implemented for malaria and TB diagnosis in the near future. We also expect that the proposed diagnostic algorithm will help concerned people from both laboratory and clinics to adopt test(s) for accurate diagnosis of kala-azar cases.

Exploration of genotype and genetic diversity analysis revealed *L. donovani* was the causative agent for kala-azar patients included from 10 endemic districts of greater Rajshahi and there was no genetic polymorphism among strains analyzed from different endemic foci. This observation has reinforced the previously published genotyping reports by different investigators from both India and Bangladesh that the same strain of *L. donovani* causing kala-azar has been circulating and clonally propagated throughout the Indian subcontinent for centuries.

5.3 Recommendations

(i) Diagnostic accuracy of buffy coat smear as suitable alternative to conventional invasive procedures like spleen or bone-marrow aspirations for parasitological diagnosis of kala-azar should be validated through multi-center study.

(ii) Considering the relapse and treatment failure of kala-azar as frequently encountered conditions, laboratory evaluation of success of treatment is always needed for every treated patient. We recommend that, studies should be carried out in future to assess the prognostic value of different tools like ELISA, buffy coat smear, PCR or LAMP, which will augment the on-going kala-azar elimination programme in Bangladesh.

(iii) PKDL is a recognized sequel of Indian VL and it is considered as reservoir for anthroponotic VL transmission, so future research should be directed towards easy and accurate detection of more PKDL cases along with exploration of facts of its host-parasite relationship for eventual effective VL elimination.

REFERENCES

References

- Adams, E.R., Schoone, G.J., Ageed, A.F., Safi, S.E. and Schallig, H.D. 2010. Development of a reverse transcriptase loop-mediated isothermal amplification (LAMP) assay for the sensitive detection of *Leishmania* parasites in clinical samples. *Am J Trop Med Hyg* **82**(4): 591-596.
- Adhya, S., Hassan, M.Q., Mukherjee, S., Manna, P.P., Basu, A., Sen, S. and Bandyopadhyay, S. 2002. Visceral leishmaniasis in India: promises and pitfalls of a PCR-based blood test. *Trans R Soc Trop Med Hyg* **96**(1): 179-183.
- Addy, M. and Nandy, A. 1992. Ten years of kala-azar in west Bengal, Part I. Did post-kala-azar dermal leishmaniasis initiate the outbreak in 24-Parganas? *Bull World Health Organ* **70**: 341-346.
- Ahluwalia, I.B., Bern, C., Costa, C., Akter, T., Chowdhury, R., Ali, M., Alam, D., Kenah, E., Amann, J., Islam, M., Wagatsuma, Y., Haque, R., Breiman, R.F. and Maguire, J.H. 2003. Visceral leishmaniasis: consequences of a neglected disease in a Bangladeshi community. *Am J Trop Med Hyg* **69**: 624-628.
- Akopyants, N.S., Kimblin, N., Secundino, N., Patrick, R., Peters, N., Lawyer, P., Dobson, D.E., Beverley, S.M. and Sacks, D.L. 2009. Demonstration of genetic exchange during cyclical development of *Leishmania* in the sand fly vector. *Science* **324**: 265-268.
- Alam, M.J., Rahman, K.M., Asna, S.M., Muazzam, N., Ahmed, I. and Chowdhury, M.Z. 1996. Comparative studies on IFAT, ELISA & DAT for serodiagnosis of visceral leishmaniasis in Bangladesh. *Bangladesh Med Res Counc Bull* **22**: 27- 32.

- Alam, M.Z., Haralambous, C., Kuhls, K., Gouzelou, E., Sgouras, D., Soteriadou, K., Schnur, L., Pratlong, F. and Schönian, G. 2009a. The paraphyletic composition of *Leishmania donovani* zymodeme MON-37 revealed by multilocus microsatellite typing. *Microbes and Infection* **11**: 707-715.
- Alam, M.Z., Kuhls, K., Schweynoch, C., Sundar, S., Rijal, S., Shamsuzzaman, A.K.M., Raju, B.V., Salotra, P., Dujardin, J.C. and Schönian, G. 2009b. Multilocus micro satellite typing (MLMT) reveals genetic homogeneity of *Leishmania donovani* strains in the Indian subcontinent. *Infection, Genetics and Evolution* **9**(1): 24-31.
- Alam, M.Z., Shamsuzzaman, A.K.M., Kuhls, K. and Schonian, G. 2009c. PCR diagnosis of visceral leishmaniasis in an endemic region, Mymensingh district, Bangladesh. *Trop Med Int Health* **14**(5): 499-503.
- Albrecht, H. 1998. Leishmaniasis: new perspectives on an underappreciated opportunistic infection. *AIDS* **12**: 2225-2226.
- Al-Jawabreh, A., Schnur, L.F., Nasereddin, A., Schwenkenbecher, J.M., Abdeen, Z., Barghuthy, F., Khanfar, H., Presber, W. and Schonian, G. 2004. The recent emergence of *Leishmania tropica* in Jericho (A'riha) and its environs, a classical focus of *L.major*. *Trop Med Int Health* **9**: 812-816.
- Alvar, J., Aparicio, P., Aseffa, A., Den Boer, M., Cañavate, C., Dedet, J.P., Gradoni, L., Ter Horst, R., López-Vélez, R. and Moreno, J. 2008. The relationship between leishmaniasis and AIDS: The second 10 years. *Clin Microbiol Rev* **21**: 334-359.
- Alvar, J., Vélez, I.D., Bern, C., Herrero, M., Desjeux, P., Cano, J., Jannin, J. and den Boer, M. 2012. Leishmaniasis Worldwide and Global Estimates of Its Incidence. *PLoS ONE* **7**(5): e35671.

- Andresen, K., Gasim, S., El-Hassan, A.M., Khalil, E.A., Barker, D.C., Theander, T.G. and Kharazmi, A. 1997. Diagnosis of visceral leishmaniasis by polymerase chain reaction using blood, bone marrow and lymph node samples from patients from the Sudan. *Trop Med Int Health* **2**: 440-444.
- Antinori, S., Calattini, S., Longhi, E., Bestetti, G., Piolin, R., Magni, C., Orlando, G., Gramiccia, M., Acquaviva, V., Foschi, A., Corvasce, S., Colomba, C., Titone, L., Parravicini, C., Cascio, A. and Corbellino, M. 2007. Clinical use of polymerase chain reaction performed on peripheral blood and bone marrow samples for the diagnosis and monitoring of visceral leishmaniasis in HIV-infected and HIV-uninfected patients: a single-center, 8-year experience in Italy and review of the literature. *Clin Infect Dis* **44**:1602-1610.
- Ashford, R.W., Bozza, M., Freire, M., Miranda, J.C., Sherlock, I., Eulalio, C., Lopes, U., Fernandes, O., Degraeve, W., Barker, R.H., Badaro, R. and David, J.R. 1995. Comparison of the polymerase chain reaction and serology for the detection of canine visceral leishmaniasis. *Am J Trop Med Hyg* **53**(3): 251-255.
- Babiker, Z.O., Davidson, R., Mazinda, C., Kipngetich, S. and Ritmeijer, K. 2007. Utility of lymph node aspiration in the diagnosis of visceral leishmaniasis in Sudan. *Am J Trop Med Hyg* **76**: 689-693.
- Bahr, M. and Bell, D.R. 1987. Visceral leishmaniasis. *In*: Manson's Tropical disease, 19th ed., WB Saunders, London, pp 87-113.
- Bañuls, A.L., Hide, M. and Tibayrenc, M. 1999. Molecular epidemiology and evolutionary genetics of *Leishmania* parasites. *Int J Parasitol* **29**: 1137-1147.

- Bañuls, A.L., Hide, M. and Prugnolle, F. 2007. Leishmania and the leishmaniasis: a parasite genetic update and advances in taxonomy, epidemiology and pathogenicity in humans. *Adv Parasitol* **64**: 1-109.
- Bensoussan, E., Nasereddin, A., Jonas, F., Schnur, L.F. and Jaffe, C.L. 2006. Comparison of PCR assays for diagnosis of cutaneous *Leishmaniasis*. *J Clin Microbiol* **44**: 1435-1439.
- Bern, C., Jha, S.N., Joshi, A.B., Thakur, G.D. and Bista, M.B. 2000. Use of the recombinant K39 dipstick test and the direct agglutination test in a setting endemic for visceral leishmaniasis in Nepal. *Am J Trop Med Hyg* **63**: 153-157.
- Bern, C., Hightower, A.W., Chowdhury, R., Ali, M., Amann, J., Wagatsuma, Y., Haque, R., Kurkjian, K., Vaz, L.E., Begum, M., Akter, T., Cetre-Sossah, C.B., Ahluwalia, I.B., Dotson, E., Secor, W.E., Breiman, R.F. and Maguire, J.H. 2005. Risk factors for kala-azar in Bangladesh. *Emerg Infect Dis* **11**(5): 655-662.
- Bern, C. and Chowdhury, R. 2006. The epidemiology of visceral leishmaniasis in Bangladesh: prospects for improved control. *Indian J Med Res* **123**(3): 275-288.
- Birley, M.H. 1993. An historical review of malaria, kala-azar and filariasis in Bangladesh in relation to the Flood Action Plan. *Ann Trop Med Parasitol* **87**: 319-334.
- Blackwell, J.M. 1996a. Genetic susceptibility to *Leishmanial* infections: studies in mice and man. *Parasitology* **112**: S67-S74.
- Blackwell, J.M. 1996b. Structure and function of the natural-resistance-associated macrophage protein (Nrampl), a candidate protein for infectious and autoimmune disease susceptibility. *Mol Med Today* **2**: 205-211.

- Blackwell, J.M. 1997. Parasite genome analysis. Progress in the *Leishmania* genome project. *Trans R Soc Trop Med Hyg* **91**: 107-110.
- Blum, J., Desjeux, P., Schwartz, E., Beck, B. and Hatz, C. 2004. Treatment of cutaneous leishmaniasis among travelers. *J Antimicrob Chemother* **53**: 158-166.
- Boelaert, M., El-Safi, S., Mousa, H., Githure, J., Mabati, P., Gurubacharya, V., Shrestha, J., Jacquet, D., De Muynck, A., Le Ray, D. and Van der Stuyft, P. 1999. Multicenter evaluation of repeatability of the direct agglutination test for visceral leishmaniasis. *Trop Med Int Health* **4**: 31-37.
- Boelaert, M., Rijal, S., Regmi, S., Singh, R., Karki, B., Jacquet, D., Chappuis, F., Campino, L., Desjeux, P., Le Ray, D., Koirala, S. and Van der Stuyft, P. 2004. A comparative study of the effectiveness of diagnostic tests for visceral leishmaniasis. *Am J Trop Med Hyg* **70**(1): 72-77.
- Boelaert, M., Bhattacharya, S., Chappuis, F., El Safi, S., Hailu, A., Mondal, D., Rijal, S., Sundar, S., Wasunna, M. and Peeling, R.W. 2007. Evaluation of rapid diagnostic tests: visceral leishmaniasis. *Nat Rev Microbiol* S30-S39.
- Boelaert, M., El-Safi, S., Hailu, A., Mukhtar, M., Rijal, S., Sundar, S., Wasunna, M., Aseffa, A., Mbui, J., Menten, J., Desjeux, P. and Peeling, R.W. 2008. Diagnostic tests for kala-azar: A multi-centre study of the freeze-dried DAT, rK39 strip test and KAtex in East Africa and the Indian subcontinent. *Trans R Soc Trop Med Hyg* **102**: 32-40.
- Boelaert, M., Meheus, F., Sanchez, A., Singh, S.P., Vanlerberghe, V., Picado, A., Meessen, B. and Sundar, S. 2009. The poorest of the poor: a poverty appraisal of households affected by visceral leishmaniasis in Bihar, India. *Trop Med Int Health* **14**: 639-644.

- Bogdan, C. and Rollinghoff, M. 1999. How do Protozoan parasites survive inside macrophage? *Parasitol Today* **15**: 22-28.
- Boité, M.C., Mauricio, I.L., Miles, M.A. and Cupolillo, E. 2012. New Insights on Taxonomy, Phylogeny and Population Genetics of *Leishmania (Viannia)* Parasites Based on Multilocus Sequence Analysis. *PLoS Negl Trop Dis* **6**(11): e1888.
- Bora, D. 1999. Epidemiology of visceral leishmaniasis in India. *Natl Med J India* **12**: 62-68.
- Bowcock, A.M., Ruiz-Linares, A., Temföhrde, J., Minch, E., Kidd, J.R. and Cavalli-Sforza, L.L. 1994. High resolution of human evolution with polymorphic microsatellites. *Nature* **368**: 455-457.
- Bray, R.S. 1985. Immunodiagnosis of leishmaniasis. *In*: K.P. Chang and R.S. Bray (ed.), *Leishmaniasis*. Elsevier Science Publishers, Amsterdam, Netherland, pp 177-181.
- Bryceson, A. 1987. Splenic aspiration procedure as performed at the Clinical Research Center, Nairobi, *In*: Peter W, Killick-Kendrick R (ed.), *The leishmaniasis*, vol. 2. Academic Press, London, United Kingdom, pp 728–729.
- Campos-Ponce, M., Ponce, C., Ponce, E. and Maingon, R.D. 2005. *Leishmania chagasi* /*infantum*: further investigations on *Leishmania* tropisms in atypical cutaneous and visceral leishmaniasis foci in Central America. *Exp Parasitol* **109**: 209-219.
- Capelli, G., Baldelli, R., Ferroglio, E., Genchi, C., Gradoni, L., Gramiccia, M., Maroli, M., Mortarino, M., Pietrobelli, M., Rossi, L. and Ruggiero, M. 2004. Monitoring of canine *Leishmaniasis* in northern Italy: an update from a scientific network. *Parasitologia* **46**: 193-197.

- Castilho, T.M., Shaw, J.J. and Floeter-Winter, L.M. 2003. New PCR assay using glucose-6-phosphate dehydrogenase for identification of *Leishmania* species. *J Clin Microbiol* **41**: 540-546.
- Chappuis, F., Rijal, S., Soto, A., Menten, J. and Boelaert, M. 2006. A meta-analysis of the diagnostic performance of the direct agglutination test and rK39 dipstick for visceral leishmaniasis. *BMJ* **333**: 723-726.
- Chappuis, F., Sundar, S., Hailu, A., Ghalib, H., Rijal, S., Peeling, R.W., Alvar, J. and Boelaert, M. 2007. Visceral leishmaniasis: what are the needs for diagnosis, treatment and control? *Nat Rev Microbiol* **5**: 873-882.
- Chatterjee, K.D. 1980. *In: Parasitology (Protozoology and Helminthology)*, 12th ed., Chatterjee Medical Publishers, Calcutta, pp 53-69.
- Chen, Y.C., Eisner, J.D., Kattar, M.M., Rassouljian-Barrett, S.L., Lafe, K., Bui, U., Limaye, A.P. and Cookson, B.T. 2001. "Polymorphic Internal Transcribed Spacer Region 1 DNA Sequences Identify Medically Important Yeasts". *J Clin Microbiol* **39**(11): 4042-4051.
- Cheesbrough, M. 1999. *District Laboratory Practice in Tropical Countries*. Cambridge University Press, Low price edition.
- Chowdhury, M.A.J., Alam, M.N., Rafiqueuddin, A.K.M., Hussain, A., Rahman, H., Siddiqui, A.B., Nazir, M.F.H., Rahman, K.M. and Biswas, A. 1990. Clinical profile of Kala azar in Rajshahi: A prospective study of 273 Hospitalized patients during one year. *Journal of Bangladesh College of Physicians and Surgeon* **8**(1): 18-28.

- Chowdhury, M.S., El-Harith, A., El-Masum, A., El-Karim, E. and al Rahman, A. 1993a. Prevalence of agglutinating anti-*Leishmania* antibodies in two multi-thousand Bengali communities. *Parasitol Res* **79**: 444-450.
- Chowdhury, M.S., Ahmed, M.T.U. and Hussain, A.M.Z. 1993b. Visceral leishmaniasis control. 1st ed., IEDCR, Dhaka, pp 4-28.
- Chulay, J.D. and Bryceson, A.D. 1983. Quantitation of amastigotes of *Leishmania donovani* in smears of splenic aspirates from patients with visceral leishmaniasis. *Am J Trop Med Hyg* **32**: 475-479.
- Constantine, C.C. 2003. Importance and pitfalls of molecular analysis to parasite epidemiology. *Trends in Parasitology* **19**: 346-348.
- Cortes, S., Mauricio, I., Almeida, A., Cristovao, J.M., Pratlong, F., Dedet, J.P. and Campino, L. 2006. Application of kDNA as a molecular marker to analyse *Leishmania infantum* diversity in Portugal. *Parasitol Int* **55**: 277-283.
- Cruz, I., Canavate, C., Rubio, J.M., Morales, M.A., Chicharro, C., Laguna, F., Jiménez-Mejías, M., Sirera, G., Videla, S. and Alvar, J. 2002. A nested polymerase chain reaction (Ln-PCR) for diagnosing and monitoring *Leishmania infantum* infection in patients co-infected with human immunodeficiency virus. *Trans R Soc Trop Med Hyg* **96** (Suppl 1): S185-189.
- Cruz, I., Chicharro, C., Nieto, J., Bailo, B., Canavate, C., Figueras, M.C. and Alvar, J. 2006. Comparison of new diagnostic tools for management of pediatric Mediterranean visceral leishmaniasis. *J Clin Microbiol* **44**: 2343-2347.
- Dabirzadeh, M., sadeghi, H.M., Baghaie, M. and Hejazi, H. 2012. Genetic Polymorphism of *Leishmania major* in Two Hyper Endemic Regions of Iran Revealed by PPIP-PCR and ITS- RFLP. *Arch Iran Med* **15**(3): 151-156.

- Deborggraeve, S., Boelaert, M., Rijal, S., De Doncker, S., Dujardin, J.C., Herdewijn, P. and Buscher, P. 2008. Diagnostic accuracy of a new *Leishmania* PCR for clinical visceral *Leishmaniasis* in Nepal and its role in diagnosis of disease. *Trop Med Int Health* **13**: 1378-1383.
- De Colmenares, M., Portus, M., Riera, C., gallego, M., Aisa, M.J., Torras, S. and Munoz, C. 1995. Detection of 72-75 kD and 123 kD fractions of leishmania antigen in urine of patients with visceral leishmaniasis. *Am J Trop Med Hyg* **52**: 427-428.
- DeLong, E.R., DeLong, D.M. and Clarke-Pearson, D.L. 1988. Comparing the areas under two or more correlated receiver operating characteristic curves: a nonparametric approach. *Biometrics* **44**: 837-845.
- Desjeux, P. 2004. Leishmaniasis: current situation and new perspectives. *Comp Immunol Microbiol Infect Dis* **27**: 305-318.
- Desjeux, P and Alvar, J. 2003. Leishmania/HIV co-infections: Epidemiology in Europe *Ann Trop Med Parasitol* **97** (Suppl 1): 3-15.
- Desjeux, P. 2001. The increase in risk factors for *Leishmaniasis* worldwide. *Trans R Soc Trop Med Hyg* **95**: 239-243.
- Disch, J., Pedras, M.J., Orsini, M., Pirmez, C., De Oliveira, M.C., Castro, M. and Rabello, A. 2005. *Leishmania* (Viannia) subgenus kDNA amplification for the diagnosis of mucosal *Leishmaniasis*. *Diagn Microbiol Infect Dis* **51**: 185-190.
- Donovan, C. 1903. The etiology of heterogeneous fevers in India. *BMJ* **2**: 1401.
- Dujardin, J.C. 2006. Risk factors in the spread of leishmaniases: towards integrated monitoring? *Trends in Parasitology* **22**: 4-6.

- El-Masum, M.A., Evans, D.A., Minter, D.M. and El-Harith, A. 1995. Visceral leishmaniasis in Bangladesh: the value of DAT as a diagnostic tool. *Trans R Soc Trop Med Hyg* **89**: 185-186.
- Elias, M., Rahman, A.J. and Khan, N.I. 1989. Visceral leishmaniasis and its control in Bangladesh. *Bull World Health Organ* **67**: 43-49.
- El-Tai, N.O., Osman, O.F., El-Fari, M., Presber, W. and Schönian, G. 2000. Genetic heterogeneity of ribosomal internal transcribed spacer in clinical samples of *Leishmania donovani* spotted on filter paper as revealed by single-strand conformation polymorphisms and sequencing. *Trans R Soc Trop Med Hyg* **94**: 575-579.
- El-Tai, N.O., El-Fari, M., Mauricio, I., Miles, M.A., Oskam, L., ElSafi, S.H. and Presber, W. 2001. *Leishmania donovani*: intra specific polymorphisms of Sudanese isolates revealed by PCR-based analyses and DNA sequencing. *Exp Parasitol* **97**: 35-44.
- Enomoto, Y., Yoshikawa, T., Ihira, M., Akimoto, S., Miyake, F., Usui, C., Suga, S., Suzuki, K., Kawana, T., Nishiyama, Y. and Asano, Y. 2005. Rapid diagnosis of herpes simplex virus infection by a loop-mediated isothermal amplification method. *J Clin Microbiol* **43**(2): 951–955.
- Felsenstein, J. 1985. Bootstrap confidence levels for phylogenetic trees. *Evolution* **39**: 783–791.
- Fisa, R., Riera, C., Ribera, E., Gallego, M. and Portus, M. 2002. A nested polymerase chain reaction for diagnosis and follow-up of human visceral leishmaniasis patients using blood samples. *Trans R Soc Trop Med Hyg* **96** (Suppl 1): S191-194.

- Fisa, R., Riera, C., López-Chejade, P., Molina, I., Gállego, M., Falcó, V., Ribera, E. and Portús, M. 2008. *Leishmania infantum* DNA Detection in Urine from Patients with Visceral Leishmaniasis and after Treatment Control. *Am J Trop Med Hyg* **78**: 741-744.
- Fleming, M.D., Trenor III, C.C., Foernzler MASu, D.D., Beier, R., Dietrich, W.F. and Andrews, N.C. 1997. Microcytic anaemia mice have a mutation in Nramp2, a candidate iron transporter gene. *Nat Genet* **16**: 383-386.
- Fraga, J., Montalvo, A.M., De Doncker, S., Dujardin, J.C. and Van der Auwera, G. 2010. Phylogeny of *Leishmania* species based on the heat-shock protein 70 gene. *Infection, Genetics and Evolution* **10**: 238-245.
- Ghose, B.N. and Bhattacharya, J.K. 1972. *In: A Treatise on Hygiene and Public Health*, 15th ed., Scientific Publishing Co., Calcutta, pp 464-466.
- Gradoni, L., Gramiccia, M. and Scalone, A. 2003. Visceral *Leishmaniasis* treatment, Italy. *Emerg Infect Dis* **9**: 1617-1620.
- Guan, L.R., Zuo, X. and Yimamu. 2003. Reemergence of visceral *Leishmaniasis* in Kashi Prefecture, Xinjiang. *Chin J ParasitolParasitic Dis* **21**: 285.
- Guernaoui, S., Boumezzough, A., Pesson, B. and Pichon, G. 2005. Entomological investigations in Chichaoua: an emerging epidemic focus of cutaneous *Leishmaniasis* in Morocco. *J Med Entomol* **42**: 697-701.
- Guizani, I. 2004. Molecular tools for studying the epidemiology of leishmaniasis. World Health Organization (ed.), Reports of the Scientific Working Group on Leishmaniasis. *World Health Organization*, Geneva, Switzerland, pp 54-70.

- Hailu, A., van der Poll, T., Berhe, N. and Kager, P.A. 2004. Elevated plasma levels of interferon (IFN)-gamma, IFN-gamma inducing cytokines, and IFN-gamma inducible CXC chemokines in visceral leishmaniasis. *Am J Trop Med Hyg* **71**: 561-567.
- Halkett, F., Simon, J.C. and Balloux, F. 2005. Tackling the population genetics of clonal and partially clonal organisms. *Trends in Ecology & Evolution* **20**: 194-201.
- Handman, E. 2001. *Leishmaniasis: Current Status of Vaccine Development*. *Clin Microbiol Rev* **14**(2): 229-243.
- Haque, A., Ekram, A.R.M.S., Sharmin, L.S., Belaluddin, M. and Salam M.A. 2010. Congenital Visceral Leishmaniasis. *Pak J Med Sci* **26**(2): 485-487.
- Harris, E., Kropp, G., Belli, A., Rodriguez, B. and Agabian, N. 1998. Single-step multiplex PCR assay for characterization of New World Leishmania complexes. *J Clin Microbiol* **36**(7): 1989-1995.
- Harith, A.E., Kolk, A.H. and Kager, P.A. 1986. A simple and economical direct agglutination test for serodiagnosis and seroepidemiological studies of visceral leishmaniasis. *Trans R Soc Trop Med Hyg* **80**: 583-587.
- Harith, A.E., Kolk, A.H., Leewenburg, J., Muigai, R., Huigen, E., Jelsma, T. and Kager, P.A. 1988. Improvement of a direct agglutination test for field studies of visceral leishmaniasis. *J Clin Microbiol* **26**: 1321-1325.
- Harms, G., Schönian, G. and Feldmeier, H. 2003. *Leishmaniasis in Germany*. *Emerg Infect Dis* **9**(7): 872-875.

- Heinzel, F.P., Sadick, M.D., Holaday, B.J., Coffman, R.L. and Locksley, R.M. 1989. Reciprocal expression of interferon gamma or interleukin 4 during the resolution or progression of murine leishmaniasis. Evidence for expansion of distinct helper T cell subsets. *J Exp Med* **169**: 59-72.
- Hide, M., Banuls, A.L. and Tibayrenc, M. 2001. Genetic heterogeneity and phylogenetic status of *Leishmania (Leishmania) infantum* zymodeme MON-1: epidemiological implications. *Parasitology* **123**: 425-432.
- Hockmeyer, W.T., Kager, P.A., Rees, P.H. and Hendricks, L.D. 1981. The culture of *Leishmania donovani* in Schneider's insect medium: its value in the diagnosis and management of patients with visceral leishmaniasis. *Trans R Soc Trop Med Hyg* **75**: 861- 863.
- Houghton, R.L., Petrescu, M., Benson, D.R., Skeiky, Y.A., Scalone, A., Badaro, R., Reed, S.G. and Gradoni, L. 1998. A cloned antigen (Recombinant k39) of leishmania chagasi diagnostic for visceral leishmaniasis in human immunodeficiency virus type 1 patient and a prognostic indicator for monitoring patients undergoing drug therapy. *J Infect Dis* **177**: 1339-1344.
- Ivens, A.C. and Smith, D.F. 1997. Parasite genome analysis. A global map of the *Leishmania major* genome: prelude to genomic sequencing. *Trans R Soc Trop Med Hyg* **91**: 111-115.
- Iwen, P.C., Hinrichs, S.H. and Ruppy, M.E. 2002. Utilization of the internal transcribed spacer regions as molecular targets to detect and identify human fungal pathogens. *Medical Mycology* **40**: 87-109.

- Jamjoom, M.B., Ashford, R.W., Bates, P.A., Chance, M.L., Kemp, S.J., Watts, P.C. and Noyes, H.A. 2004. *Leishmania donovani* is the only cause of visceral *Leishmaniasis* in East Africa; previous descriptions of *L. infantum* and “*L. archibaldi*” from this region are a consequence of convergent evolution in the isoenzyme data. *Parasitology* **129**: 399-409.
- Jelinek, T., Eichenlaub, S. and Loscher, T. 1999. Sensitivity and specificity of a rapid immunochromatographic test for diagnosis of visceral leishmaniasis. *Eur J Clin Microbiol Infect Dis* **18**: 669-670.
- Jeronimo, S.M., de Queiroz Sousa, A. and Pearson RD. 2006. Leishmaniasis. Guerrant RL, Walker DH, Weller PF (eds.), *Tropical Infectious Diseases: Principles, Pathogens and Practice*: Churchill Livingstone, Elsevier, Edinburgh, Scotland, pp 1095-1113.
- Johnston, V., Stockley, J.M., Dockrell, D., Warrell, D., Bailey, R., Pasvol, G., Klein, J., Ustianowski, A., Jones, M., Beeching, N.J., Brown, M., Chapman, A.L., Sanderson, F. and Whitty, C.J. 2009. Fever in returned travellers presenting in the United Kingdom: recommendations for investigation and initial management. *J Infect* **59**(1): 1-18.
- Joshi, A., Narain, J.P., Prasittisuk, C., Bhatia, R., Hashim, G., Jorge, A., Banjara, M. and Kroeger, A. 2008. Can visceral leishmaniasis be eliminated from Asia? *Journal Vector Borne Dis* **45**: 105-111.
- Kager, P.A. and Rees, P.H. 1983. Splenic aspiration. Review of the literature. *Trop Geogr Med* **5**: 111-124.
- Kalinowski, S.T. 2005. Do polymorphic loci require larger sample sizes to estimate genetic distances? *Heredity* **94**: 33-36.

- Kalon Biological Ltd., Aldershot, Hants, United Kingdom, 2005.
<http://www.kalonbio.co.uk/html/leishmania.html>
- Kamhawi, S. 2000. The biological and immunomodulatory properties of sandfly saliva and its role in the establishment of *Leishmania* infections. *Microbes Infect* **2**(14): 1765-1773.
- Karunaweera, N.D., Pratlong, F., Siriwardane, H.V., Ithalamulla, R.L. and Dedet, J.P. 2003. Sri Lankan cutaneous *Leishmaniasis* is caused by *Leishmania donovani* zymodeme MON-37. *Trans R Soc Trop Med Hyg* **97**: 380-381.
- Katakura, K., Kawazu, S.I., Naya, T., Nagakura, K., Ito, M., Aikawa, M., Qu, J.Q., Guan, L.R., Zuo, X.P., Chai, J.J., Chang, K.P. and Matsumoto, Y. 1998. Diagnosis of kala-azar by nested PCR based on amplification of the *Leishmania* mini-exon gene. *J Clin Microbiol* **36**(8): 2173-2177.
- Kato, H., Uezato, H., Katakura, K., Calvopina, M., Marco, J.D., Barroso, P.A., Gomez, E.A., Mimori, T., Korenaga, M., Iwata, H., Nonaka, S. and Hashiguchi, Y. 2005. Detection and identification of *Leishmania* species within naturally infected sand flies in the Andean areas of Ecuador by a polymerase chain reaction. *Am J Trop Med Hyg* **72**: 87-93.
- Khan, M.G., Bhaskar, K.R.H., Salam, M.A., Akther, T., Pluschke, G. and Mondal, D. 2012. Diagnostic accuracy of loop-mediated isothermal amplification (LAMP) for detection of *Leishmania* DNA in buffy coat from visceral leishmaniasis patients. *Parasites & Vectors* **5**: 280.
- Killick-Kendrick, R. 1990. Phlebotomine vectors of the leishmaniasis: a review. *Med Vet Entomol* **4**(1): 1-24.

- Kostman, R., Barr, M., Bengtsson, E., Garnham, P.C.C., Hult, G. et al. 1963. Kala-azar transferred by exchange blood transfusion in two Swedish infants. *In: Proceedings of the 7th International Congress of Tropical Medicine and Malaria. World Health Organization, Geneva, Switzerland, p384.*
- Kuhls, K., Mauricio, I.L., Pralong, F., Presber, W. and Schönian, G. 2005. Analysis of ribosomal DNA internal transcribed spacer sequences of the *Leishmania donovani* complex. *Microbes Infect* **7**: 1224-1234.
- Kuhls, K., Keilonat, L., Ochsenreither, S., Schaar, M., Schweynoch, C., Presber, W. and Schönian, G. 2007. Multilocus microsatellite typing (MLMT) reveals genetically isolated populations between and within the main endemic regions of visceral leishmaniasis. *Microbes Infect* **9**: 334-343.
- Kumar, R., Pai, K., Pathak, K. and Sundar, S. 2001. Enzyme-linked immunosorbent assay for recombinant K39 antigen in diagnosis and prognosis of Indian visceral leishmaniasis. *Clin Diagn Lab Immunol* **8**: 1220-1224.
- Kurkjian, K.M., Vaz, L.E., Haque, R., Cetre-Sossah, C., Akhter, S., Roy, S., Steurer, F., Amann, J., Ali, M., Chowdhury, R., Wagatsuma, Y., Williamson, J., Crawford, S., Breiman, R.F., Maguire, J.H., Bern, C. and Secor, W.E. 2005. Application of an improved method for the recombinant k39 enzyme-linked immunosorbent assay to detect visceral leishmaniasis disease and infection in Bangladesh. *Clin Diagn Lab Immunol* **12**: 1410-1415.
- Lachaud, L., Chabbert, E., Dubessay, P., Reynes, J., Lamothe, J. and Bastein, P. 2001. Comparison of various sample preparation methods of PCR diagnosis of visceral leishmaniasis using peripheral blood. *J Clin Microbiol* **38**: 613-617.

- Lachaud, L., Marchergui-Hammami, S., Chabbert, E., Dereure, J., Dedet, J.P. and Bastien, P. 2002. Comparison of six PCR methods using peripheral blood for detection of canine visceral *Leishmaniasis*. *J Clin Microbiol* **40**: 210-215.
- Lainson, R. and Shaw, J.J. 1987. Evolution, classification and geographical distribution, *In* W. Peters and R. Killick-Kendrick (ed.), *The leishmaniasis in biology and medicine*, Academic Press, Orlando, Fla, pp 1-120.
- Lau, Y.L., Fong, M.Y., Mahmud, R., Chang, P.Y., Palaeya, V., Cheong, F.W., Chin, L.C., Anthony, C.N., Al-Mekhlafi, A.M. and Chen, Y. 2011. Specific, sensitive and rapid detection of human plasmodium knowlesi infection by loop-mediated isothermal amplification (LAMP) in blood samples. *Malar J* **10**: 197.
- Laurent, T., Rijal, S., Yardley, V., Croft, S., De Doncker, S., Decuypere, S., Khanal, B., Singh, R., Schönian, G., Kuhls, K., Chappuis, F. and Dujardin, J.C. 2007. Epidemiological dynamics of antimonial resistance in *Leishmania donovani*: genotyping reveals a polyclonal population structure among naturally-resistant clinical isolates from Nepal. *Infection, Genetics and Evolution* **7**: 206-212.
- Laurent, T., Van der Auwera, G., Hide, M., Mertens, P., Quispe-Tintaya, W., Deborggraeve, S., De Doncker, S., Leclipteux, T., Banuls, A.L., Buscher, P. and Dujardin, J.C. 2009. Identification of Old World *Leishmania* spp. by specific polymerase chain reaction amplification of cysteine proteinase B genes and rapid dipstick detection. *Diag Microbiol Infect Dis* **63**: 173-181.
- Leclercq, V., Lebastard, M., Belkaid, Y., Louis, J. and Milon, G. 1996. The outcome of the parasitic process initiated by *Leishmania infantum* in laboratory mice: a tissue-dependent pattern controlled by the *Lsh* and MHC loci. *J Immunol* **157**: 4537-4545.

- Le Fichoux, Y., Quaranta, J.F., Aueuvre, J.P., Lelièvre, A., Marty, P. and Suffia, I. 1999. Occurrence of *Leishmania infantum* parasitemia in asymptomatic blood donors living in an area of endemicity in southern France. *J Clin Microbiol* **37**: 1953-1957.
- Leishman, W.B. 1903. On the possibility of occurrence of trypanosomiasis in India. *BMJ* **1**: 1252-1254.
- Liese, J., Schleicher, U. and Bogdan, C. 2008. The innate immune response against *Leishmania* parasites. *Immunobiology* **213**: 377-387.
- López-Vélez, R., Laguna, F., Alvar, J., Perez-Molina, J.A., Molina, R., Martinez, P. and Villarrubia, J. 1995. Parasitic culture of buffy coat for diagnosis of visceral leishmaniasis in human immunodeficiency virus-infected patients. *J Clin Microbiol* **33**: 937-939.
- Maegraith, B. 1989. Leishmaniasis. *In*: Adams and Maegraith's Clinical Tropical Diseases, 9th ed., Blackwell, London, pp 152-166.
- Maia, Z., Lírio, M., Mistro, S., Mendes, C.M., Mehta, S.R. and Badaro, R. 2012. Comparative Study of rK39 *Leishmania* Antigen for Serodiagnosis of Visceral Leishmaniasis: Systematic Review with Meta-Analysis. *PLoS Negl Trop Dis* **6**(1): e1484.
- Maalej, I.A., Chenik, M., Louzir, H., Ben Salah, A., Bahloul, C., Amri, F. and Dellagi, K. 2003. Comparative evaluation of ELISAs based on ten recombinant or purified *Leishmania* antigens for the serodiagnosis of Mediterranean visceral leishmaniasis. *Am J Trop Med Hyg* **68**: 312-320.

- Mann, D.L., Garner, R.P., Dayhoff, D.E., Cao, K., Fernandez-Vina, M.A., Davis, C., Aronson, N., Ruiz, N., Birx, D.L. and Michael, N.L. 1998. Major histocompatibility complex genotype is associated with disease progression and virus load levels in a cohort of human immunodeficiency virus type 1-infected Caucasians and African Americans. *J Infect Dis* **178**: 1799-1802.
- Manson-Bahr, P.E.C. and Bell, D.R. 1987. *In: Manson's Tropical Diseases*, 19th ed., Bailliere Tindall (ELBS), London, pp 87-113.
- Marfurt, J., Nasereddin, A., Niederwieser, I., Jaffe, C.L., Beck, H.P. and Felger, I. 2003. Identification and Differentiation of *Leishmania* Species in Clinical Samples by PCR Amplification of the Miniexon Sequence and Subsequent Restriction Fragment Length Polymorphism Analysis. *J Clin Microbiol* **41**: 3137-3153.
- Martínez, P., de la Vega, E., Laguna, F., Soriano, V., Puente, S., Moreno, V., Sentchordi, M.J., Garcia-Aguado, C. and Gonzalez-Lahoz, J. 1993. Diagnosis of visceral leishmaniasis in HIV infected individuals using peripheral blood smears. *AIDS* **7**: 227-230.
- Mary, C., Lamouroux, D., Dunan, S. and Quilci, M. 1992. Western blot analysis of antibodies to *Leishmania infantum* antigen: potential of the 14-kD and 16-kD antigens for diagnosis and epidemiologic purposes. *Am J Trop Med Hyg* **47**: 764-771.
- Mauricio, I.L., Gaunt, M.W., Stothard, J.R. and Miles, M.A. 2001. Genetic typing and phylogeny of the *Leishmania donovani* complex by restriction analysis of PCR amplified gp63 intergenic regions. *Parasitology* **122**: 393-403.

- Mauricio, I.L., Stothard, J.R. and Miles, M.A. 2004. *Leishmania donovani* complex: genotyping with the ribosomal internal transcribed spacer and the mini-exon. *Parasitology* **128**: 263-267.
- Mauricio, I.L., Yeo, M., Baghaei, M., Doto, D., Pratlong, F., Zemanova, E., Dedet, J.P., Lukes, J. and Miles, M.A. 2006. Towards multilocus sequence typing of the *Leishmania donovani* complex: resolving genotypes and haplotypes for five polymorphic metabolic enzymes (ASAT, GPI, NH1, NH2, PGD). *Int J Parasitol* **36**: 757-769.
- Mauricio, I.L., Gaunt, M.W., Stothard, J.R. and Miles, M.A. 2007. Glycoprotein 63 (gp63) genes show gene conversion and reveal the evolution of Old World *Leishmania*. *Int J Parasitol* **37**(5): 565-576.
- Maurya, R., Singh, R.K., Kumar, B., Salotra, P., Rai, M. and Sundar, S. 2005. Evaluation of PCR for Diagnosis of Indian Kala-Azar and Assessment of Cure. *J Clin Microbiol* **43**: 3038-3041.
- Minch, E., Ruiz-Linares, A., Goldstein, D.B., Feldman, M.W. and Cavalli-Sforza, L.L. 1995. MICROSAT (<http://lotka.stanford.edu/microsat.html>).
- Minodier, P., Piarroux, R., Gambrelli, F., Joblet, C. and Dumon, J. 1997. Rapid identification of causative species in patients with Old World leishmaniasis. *J Clin Microbiol* **35**: 2551-2555.
- Mohapatra, T.M., Singh, D.P., Sen, M.R., Bharti, K. and Sundar, S. 2010. Comparative evaluation of rK9, rK26 and rK39 antigens in the serodiagnosis of Indian visceral leishmaniasis. *J Infect Dev Ctries* **4**: 114-117.
- Mondal, S., Bhattacharya, P. and Ali, N. 2010. Current diagnosis and treatment of visceral leishmaniasis. *Expert Review of Anti-infective Therapy* **8**(8): 919-944.

- Monica, C. 1998. District laboratory practice in tropical countries, part I, Cambridge University Press, Cambridge, United Kingdom, pp 275-280.
- Morales, M.A., Cruz, I., Rubio, J.M., Chicharro, C., Canavate, C., Laguna, F. and Alvar, J. 2002. Relapses versus reinfections in patients coinfectd with *Leishmania infantum* and human immunodeficiency virus type 1. *J Infect Dis* **185**: 1533-1537.
- Mori, Y., Nagamine, K., Tomita, N. and Notomi, T. 2001. Detection of loop-mediated isothermal amplification reaction by turbidity derived from magnesium pyrophosphate formation. *Biochem Biophys Res Commun* **289**(1): 150-154.
- Mortarino, M., Franceschi, A., Mancianti, F., Bazzocchi, C., Genchi, C. and Bandi, C. 2004. Quantitative PCR in the diagnosis of Leishmania. *Parasitologia* **46**(1-2): 163-167.
- Motazedian, H., Karamian, M., Noyes, H.A. and Ardehali, S. 2002. DNA extraction and amplification of Leishmania from archived, Giemsa-stained slides, for the diagnosis of cutaneous leishmaniasis by PCR. *Ann Trop Med Parasitol* **96**: 31-34.
- Muazzam, N., Rahman, K.M., Miah, R.A. and Asna, S.M. 1992. Indirect fluorescent antibody test in the serodiagnosis of visceral leishmaniasis in Bangladesh. *Bangladesh Med Res Counc Bull* **18**: 77-81.
- Nagamine, K., Hase, T. and Notomi, T. 2002. Accelerated reaction by loop-mediated isothermal amplification using loop primers. *Mol Cell Probes* **16**: 223-229.
- Napier, L. 1937. Pulmonary Tuberculosis and Kala-azar: a fatal combination. *Indian Med Gaz* **72**: 242-243.

- Nasereddin, A., Baneth, G., Schonian, G., Kanaan, M. and Jaffe, C. 2005. Molecular fingerprinting of *Leishmania infantum* strains following an outbreak of visceral *Leishmaniasis* in central Israel. *J Clin Microbiol* **43**: 6054-6059.
- Nasereddin, A., Bensoussan-Hermano, E., Schönian, G., Baneth, G. and Jaffe, C. 2008. Molecular diagnosis and species identification of Old World cutaneous *Leishmaniasis* using a reverse line blot hybridization assay. *J Clin Microbiol* **46**: 2848-2855.
- Nasiruddin, M. 1952. DDT in the prevention of kala-azar in East Pakistan. *Pakistan Journal of Health* **1**: 21-24.
- Njiru, Z.K., Mikosza, A.S., Matovu, E., Enyaru, J.C., Ouma, J.O., Kibona, S.N., Thompson, R.C. and Ndung'u, J.M. 2008. African trypanosomiasis: sensitive and rapid detection of the sub-genus Trypanozoon by loop-mediated isothermal amplification (LAMP) of parasite DNA. *Int J Parasitol* **38**(5): 589–599.
- Notomi, T., Okayama, H., Masubuchi, H., Yonekawa, T., Watanabe, K., Amino, N. and Hase, T. 2000. Loop-mediated isothermal amplification of DNA. *Nucleic Acids Res* **28**: E63.
- Osman, O.F., Kager, P.A., Zijlstra, E.E., El-Hassan, A.M. and Oskam, L. 1997. Use of PCR on lymph-node sample as test of cure of visceral leishmaniasis. *Ann Trop Med Parasitol* **91**: 845-850.
- Pandey, K.T., Yanagi, B.D., Pandey, A.K., Mallik, J.B., Sherchand, and Kanbara, H. 2007. Characterization of *Leishmania* isolates from Nepalese patients with visceral leishmaniasis. *Parasitol Res* **100**: 1361-1369.

- Park, J.E. and Park, K. 2000. Park's Textbook of Preventive and Social Medicine, 16th ed., M/S Banarsidas Bhanot Publishers, Jabalpur, India, pp 231-233.
- Pattabhi, S., Whittle, J., Mohamath, R., El-safi, S., Moulton, G.G., Guderian, J.A., Colombara, D., Abdoon, A.O., Mukhtar, M.M., Mondal, D., Esfandiari, J., Kumar, S., Chun, P., Reed, S.G. and Bhatia, A. 2010. Design, development and evaluation of rK28-based point-of-care tests for improving rapid diagnosis of visceral leishmaniasis. *PLoS Negl Trop Dis* **4**: e822.
- Pearson, R.D., De Queiroz Sousa, A. and Jeronimo, S.M.B. 2001. Leishmania Species: Visceral (Kala-Azar), Cutaneous and Mucosal Leishmaniasis. In: G.L. Mandell, J.E. Bennett, & R. Dolin (eds.), Principles and practice of infectious diseases: Churchill Livingstone, New York, pp 2831-2845.
- Peay, K.G., Kennedy, P.G. and Bruns, T.D. 2008. "Fungal community ecology: a hybrid beast with a molecular master". *BioScience* **58**: 799-810.
- Pratlong, F., Dereure, J., Bucheton, B., El-Safi, S., Dessein, A., Lanotte, G. and Dedet, J.P. 2001. Sudan: the possible original focus of Visceral Leishmaniasis. *Parasitol* **122**: 599-605.
- Qiagen Inc., Valencia, CA, Cat. No. 51106; <http://www.qiagen.com>
- Quispe Tintaya, K.W., Laurent, T., Decuypere, S., Hide, M., Banuls, A.L., De Doncker, S., Rijal, S., Canavate, C., Campino, L. and Dujardin, J.C. 2005. Fluorogenic assay for molecular typing of the *Leishmania donovani* complex: taxonomic and clinical applications. *J Infect Dis* **192**(4): 685-692.
- Rahman, K.M. and Islam, N. 1983. Resurgence of visceral leishmaniasis in Bangladesh. *Bulletin of the World Health Organization* **61**: 113-116.

- Rahman, R., Bengali, M., Kabir, H., Naher, F.B. and Mahboob, S. 2008. Kala-azar situation in Bangladesh. *In*: Hossain M. (ed.), National Guideline and Training Module for Kala-azar Elimination in Bangladesh, 1st ed., CDC, DGHS, Ministry of Health and Family Welfare, Government of the Peoples Republic of Bangladesh, pp11-12.
- Ramos, A., Maslov, D.A., Fernandes, O., Campbell, D.A. and Simpson, L. 1996. Detection and identification of human pathogenic *Leishmania* and *Trypanosoma* species by hybridization of PCR-amplified mini-exon repeats. *Exp Parasitol* **82**: 242-250.
- Reithinger, R. and Dujardin, J.C. 2007. Molecular diagnosis of leishmaniasis: current status and future applications. *J Clin Microbiol* **45**: 21-25.
- Rijal, S., Koirala, S., Van der Stuyft, P. and Boeleart, M. 2006. .The economic burden of visceral leishmaniasis for households in Nepal. *Trans R Soc Trop Med Hyg* **100**(9): 838.841.
- Ritmeijer, K., Melaku, Y., Mueller, M., Kipnetich, S., O'keeffe, C. and Davidson, R.N. 2006. Evaluation of a new recombinant K39 rapid diagnostic test for Sudanese visceral leishmaniasis. *Am J Trop Med Hyg* **74**: 76-80.
- Roberts, L.J., Handman, E. and Foote, S.J. 2000. *Leishmaniasis* in the new genetic era. *BMJ* **321**: 801-804.
- Roelfsema, J.H., Nozari, N., Herremans, T., Kortbeek, L.M. and Pinelli, E. 2011. Evaluation and improvement of two PCR targets in molecular typing of clinical samples of *Leishmania* patients. *Exp Parasitol* **127**: 36-41.

- Rogers, L. 1944. Kala-azar. *In*: Rogers L and Mecaw JWD (eds.), Tropical Medicine. 4th ed., J & A Churchill Ltd., London, pp 60-77.
- Romero, G.A., Guerra, M.V., Paes, M.G. and Macedo, V.O. 2001. Comparison of cutaneous leishmaniasis due to *Leishmania (Viannia) braziliensis* and *L.(V.) guyanensis* in Brasil: therapeutic response to meglumine antimoniate. *Am J Trop Med Hyg* **65**: 456-465.
- Rosenthal, P.J., Chaisson, R.E., Hadley, W.K. and Leech, J.H. 1998. Rectal leishmaniasis in a patient with acquired immunodeficiency syndrome. *Am J Med* **84**: 307-309.
- Rosenthal, E., Marty, P., del Giudice, P., Pradier, C., Ceppi, C., Gastaut, J.A., Fichoux, Y.L. and Cassuto, J.P. 2000. HIV and leishmania coinfection: a review of 91 cases with focus on atypical locations of leishmania. *Clin Infect Dis* **31**: 1093-1095.
- Ross, R. 1903. Further notes on Leishman's bodies. *BMJ* **2** : 1401.
- Roy, C.K., Safiullah, S.A., Saleh, A.A. and Miah, M.R.A. 2009. Detection of LD body in Peripheral Blood Buffy-coat from Suspected Kala-azar Cases of Bangladesh. *Bangladesh J Med Microbiol* **3**(1): 27-32.
- Sacks, D.L., Kenny, R.T., Kreutzer, R.D., Jaffe, C.L., Gupta, A.K., Sharma, M.C., Sinha, S.P., Neua, F.V. and Saran, R. 1995. Indian kala-azar caused by *Leishmania tropica*. *Lancet* **345**: 959-961.
- Saha, S., Mondal, S., Banerjee, A., Ghose, J., Bhowmick, S. and Nahid, A. 2006. Immune responses in kala-azar. *Indian J Med Res* **123**: 245-266.

- Saitou, N. and Nei, M. 1987. The neighbor-joining method: a new method for reconstructing phylogenetic trees. *Mol Biol Evol* **4**(4): 406-425.
- Saki, J., Meamar, A.R., Oormazdi, H., Akhlaghi, L., Maraghi, S., Mohebali, M. and Razmjou, E. 2010. Mini-Exon Genotyping of *Leishmania* Species in Khuzestan Province, Southwest Iran. *Iran J Parasitol* **5**(1): 25-34.
- Salam, M.A., Ahmed, I., Ali, M.S., Hossain, S.M.A. and Begum, S. 2003. Microscopic Detection of L.D. Bodies in Splenic Aspirate at Rajshahi Medical College Hospital. *The Journal of Teachers Association (TAJ)*, Rajshahi Medical College, Rajshahi-6000, Bangladesh. **16**(1): 20-23.
- Salam, M.A. 2008. Immunochromatographic strip test detection of anti-rK39 antibody for the diagnosis of kala-azar in an endemic zone of Bangladesh. *Pak J Med Sci* **24**(4): 497-501.
- Salam, M.A., Mondal, D., Kabir, M. and Haque, R. 2009. rK39 Enzyme-Linked Immunosorbent Assay for the diagnosis of kala-azar in an endemic zone of Bangladesh. *Pak J Med Sci* **25**(4): 635-640.
- Salam, M.A., Mondal, D., Kabir, M., Ekram, A.R.M.S. and Haque, R. 2010. PCR for diagnosis and assessment of cure in kala-azar patients in Bangladesh. *Acta Trop* **113**: 52-55.
- Salam, M.A., Mondal, D., Kabir, M. and Haque, R. 2010. Detection of urinary leishmanial antigen by latex agglutination test (KAtex) in kala-azar patients. *Bangladesh J Med Sci* **9**(4): 216-222.
- Salam, M.A., Khan, M.G.M. and Mondal, D. 2011. Urine antigen detection by latex agglutination test for diagnosis and assessment of initial cure of visceral leishmaniasis. *Trans R Soc Trop Med Hyg* **105**(5): 269-272.

- Salam, M.A., Khan, M.G.M., Bhaskar, K.R.H., Afrad, M.H., Huda, M.M. and Mondal, D. 2012. Peripheral Blood Buffy Coat Smear: a Promising Tool for Diagnosis of Visceral Leishmaniasis. *J Clin Microbiol* **50**: 837-840.
- Salma, U., Khan, A.H., Rahaman, M.F.U., Irshadullah, N.M., Shumy, F. and Chowdhury, M.A.J. 2012. Leishmanial Hepatitis with Chronic Hepatitis B Infection Treated Successfully with Liquid Form of Liposomal Amphotericin B - A Case Report. *BSMMU J* **5**(1): 55-56.
- Salotra, P., Sreenivas, G., Pogue, G.P., Lee, N., Nakhasi, H.L., Ramesh, V. and Negi, N.S. 2001. Development of a species-specific PCR assay for detection of *Leishmania donovani* in clinical samples from patients with kala-azar and post-kala-azar dermal Leishmaniasis. *J Clin Microbiol* **39**: 849-854.
- Sanyal, R.K. 1985. Leishmaniasis in the Indian sub-continent. *In*: Chang KP, Bray RS, (eds.) *Leishmaniasis*. Elsevier Science Publishers, B.V., Amsterdam, pp 443-467.
- Saran, R., Sharma, M.C., Gupta, A.K., Sinha, S.P. and Kar, S.K. 1997. Diurnal periodicity of *Leishmania amastigotes* in peripheral blood of Indian Kala-azar patients. *Acta Trop* **68**: 357-360.
- Sarker, C.B., Chowdhury, K.S., Siddiqui, N.I., Jamal, M.F., Rahman, S., Momen, A., Dhar, D.K. and Alam, K.S. 2003a. Clinical profile of kala-azar in adults: As seen in Mymensingh Medical College Hospital, Mymensingh, Bangladesh. *Mymensingh Med J* **12**(1): 41-44.
- Sarker, C.B., Momen, A., Jamal, M.F., Siddiqui, N.I., Siddiqui, F.M., Chowdhury, K.S., Rahman, S. and Talukder, S.I. 2003b. Immunochromatographic (rK39) strip test in the diagnosis of visceral leishmaniasis in Bangladesh. *Mymensingh Med J* **12**: 93-97.

- Sarker, C.B., Alam, K.S., Jamal, M.F., Rahman, S., Huq, M.H., Musa, A.K., Sutradhar, S.R., Talukder, S.I. and Debnath, C.R. 2004. Sensitivity of splenic and bone marrow aspirate study for diagnosis of kala-azar. *Mymensingh Med J* **13**: 130-133.
- Schallig, H.D., Schoone, G.J., Kroon, C.C., Hailu, A., Chappuis, F. and Veeken, H. 2001. Development and application of 'simple' diagnostic tools for visceral leishmaniasis. *Med Microbiol Immunol* **190**: 69-71.
- Schönian, G., Schnur, L., El Fari, M., Oskam, L., Kolesnikov, A.A., Sokolowska-Köhler, W. and Presber, W. 2001. Genetic heterogeneity in the species *Leishmania tropica* revealed by different PCR-based methods. *Trans R Soc Trop Med Hyg* **95**: 217-224.
- Schönian, G., Nasereddin, A., Dinse, N., Schweynoch, C., Schallig, H.D., Presber, W. and Jaffe, C.L. 2003. PCR diagnosis and characterization of *Leishmania* in local and imported clinical samples. *Diag Microbiol Infect Dis* **47**: 349-358.
- Schönian, G., Mauricio, I., Gramiccia, M., Canavate, C., Boelaert, M. and Dujardin, J.C. 2008. *Leishmaniases* in the Mediterranean in the era of molecular epidemiology. *Trends in Parasitology* **24**: 135-142.
- Schönian, G., Kuhls, K. and Mauricio, I.L. 2011. Molecular approaches for a better understanding of the epidemiology and population genetics of *Leishmania*. *Parasitology* **138**(4): 405-425.
- Schur, L.F. and Jacobson, R.L. 2001. Parasitological techniques. In: W. Peters and R. Killick-Kendrick (ed.), *Leishmaniasis in biology and medicine*, vol. 1. Academic Press, New York, N.Y. pp 500-541.

- Sengupta, P.C. 1944. Kala-azar in Bengal: its incidence and trends. *Indian Med Gaz* **79**: 547-552.
- Sengupta, P.C. 1947. Observations on an outbreak of kala-azar in Calcutta. *Indian Med Gaz* **82**: 726-734.
- Sengupta, P.C. 1975. Return of kala-azar. *J Indian Med Assoc* **65**: 89-90.
- Shamsuzzaman, A.K.M., Mahmud, M.C., Akhter, S., Musa, A.K.M. and Hossain, M.A. 2007. LD Bodies From Blood Buffy Coat: an Easy Approach for Definitive Diagnosis of Visceral Leishmaniasis. *Bangladesh J Med Microbiol* **01**(02): 43-47.
- Shani-Adir, A., Kamil, S., Rozenman, D., Schwartz, E., Ramon, M., Zalman, L., Nasereddin, A., Jaffe, C.L. and Ephros, M. 2005. *Leishmania tropica* in northern Israel: a clinical overview of an emerging focus. *J Am Acad Dermatol* **53**: 810-815.
- Sharma, M.C., Gupta, A.K., Das, V.N., Verma, N., Kumar, N., Sran, R. and Kar, S.K. 2000. *Leishmania donovani* in blood smears of asymptomatic persons. *Acta Trop* **76**: 195-196.
- Sharma, N.L., Mahajan, V.K., Kanga, A., Sood, A., Katoch, V.M., Mauricio, I., Singh, C.D., Parwan, U.C., Sharma, V.K. and Sharma, R.C. 2005. Localized cutaneous *Leishmaniasis* due to *Leishmania donovani* and *Leishmania tropica*: preliminary findings of the study of 161 new cases from a new endemic focus in Himachal Pradesh, India. *Am J Trop Med Hyg* **72**: 819-824.
- Shlomai, J. 1994. The assembly of kinetoplast DNA. *Parasitol Today* **10**(9): 341-346.

- Shortt, H.E., Smith, R.O.A., Swaminath, C.S. and Krishnan, K.V. 1931. Transmission of Indian kala-azar by the bite of *Phlebotomus argentipes*. *Indian J Med Res* **18**: 1373-1375.
- Singal, P. and Singh, P.P. 2005. Leishmania donovani amastigote components-induced colony stimulating factors production. *Parasitol Int* **54**: 9-20.
- Singh, S., Gilman-Sachs, A., Chang, K.P. and Reed, S.G. 1995. Diagnostic and prognostic value of K39 recombinant antigen in Indian leishmaniasis. *J Parasitol* **81**: 1000-1003.
- Singh, S., Kumari, V. and Singh, N. 2002. Predicting kala-azar disease manifestations in asymptomatic patients with latent *Leishmania donovani* infection by detection of antibody against recombinant K39 antigen. *Clin Diagn Lab Immunol* **9**: 568-572.
- Sinha, R. and Sehgal, S. 1994. Comparative evaluation of serological tests in Indian kala-azar. *J Trop Med Hyg* **97**(6): 333-340.
- Sinha, P.K., Pandey, K. and Bhattacharya, S.K. 2005. Diagnosis & management of leishmania/HIV co-infection. *Indian J Med Res* **121**: 407-414.
- Srivastava, P., Singh, T. and Sundar, S. 2011. Genetic Heterogeneity in Clinical Isolates of *Leishmania donovani* from India. *J Clin Microbiol* **49**(10): 3687-3690.
- Sundar, S., Reed, S.G., Singh, V.P., Kumar, K. and Murray, H.W. 1998. Rapid accurate field diagnosis of visceral leishmaniasis. *Lancet* **351**: 563-565.

- Sundar, S., Pai, K., Kumar, R., Tripathi, K.P., Gam, A.A., Roy, M. and Kenny, R.T. 2001. Resistance to treatment in kala-azar: speciation of isolates from Northeast India. *Am J Trop Med Hyg* **65**: 193-196.
- Sundar, S. and Rai, M. 2002a. Laboratory diagnosis of visceral leishmaniasis. *Clin Diag Lab Immunol* **9**(5): 951-958.
- Sundar, S., Pai, K., Sahu, M., Kumar, V. and Murray, H.W. 2002b. Immunochromatographic strip test detection of anti k39 antibody in Indian visceral leishmaniasis. *Ann Trop Med Parasitol* **96**: 19-23.
- Sundar, S., Agrawal, S., Pai, K., Chance, M. and Hommel, M. 2005. Detection of leishmanial antigen in the urine of patients with visceral leishmaniasis by latex agglutination test (KATEX). *Am J Trop Med Hyg* **73**(2): 269-271.
- Sundar, S., Maurya, R., Singh, R.K., Bharti, K., Chakravarty, J., Parekh, A., Rai, M., Kumar, K. and Murray, H.W. 2006. Rapid, noninvasive diagnosis of visceral leishmaniasis in India: Comparison of two immunochromatographic strip tests for detection of anti-K39 antibody. *J Clin Microbiol* **44**: 251-253.
- Sundar, S., Singh, R.K., Bimal, S.K., Gidwani, K., Mishra, A., Maurya, R., Singh, S.K., Manandhar, K.D., Boelaert, M. and Rai, M. 2007. Comparative evaluation of parasitology and serological tests in the diagnosis of visceral leishmaniasis in India: a phase III diagnostic accuracy study. *Trop Med Int Health* **12**: 284-289.
- Sundar, S. and Chakravarty, J. 2012. Recent advances in the diagnosis and treatment of kala-azar. *Natl Med J India* **25**(2): 85-89.

- Svobodova, M., Votypka, J., Peckova, J., Dvorak, V., Nasereddin, A., Baneth, G., Sztern, J., Kravchenko, V., Orr, A., Meir, D., Schnur, L.F., Volf, P. and Warburg A. 2006a. Distinct transmission cycles of *Leishmania tropica* in 2 adjacent foci, northern Israel. *Emerg Infect Dis* **12**(12): 1860-1868.
- Svobodova, M., Volf, P. and Votypka, J. 2006b. Experimental transmission of *Leishmania tropica* to hyraxes (*Procavia capensis*) by the bite of *Phlebotomus arabicus*. *Microbes Infect* **8**: 1691-1694.
- Svobodova, M., Alten, B., Zidkova, L., Dvorak, V., Hlavackova, J., Myskova, J., Seblova, V., Kasap, O.E., Belen, A., Votypka, J. and Volf, P. 2009. Cutaneous *Leishmaniasis* caused by *Leishmania infantum* transmitted by *Phlebotomus tobbi*. *Int J Parasitol* **39**: 251-256.
- Swaminath, C.S., Shortt, H.E. and Anderson, L.A.P. 1942. Transmission of Indian kala-azar to man by bites of *Phlebotomus argentipes* Ann and Brun India. *Indian J Med Res* **30**: 473-477.
- Takagi, H., Itoh, M., Islam, M.Z., Razzaque, A., Ekram, A.R.M.S., Hashighuchi, Y., Noiri, E. and Kimura, E. 2009. Sensitive, Specific, and Rapid Detection of *Leishmania donovani* DNA by Loop-Mediated Isothermal Amplification. *Am J Trop Med Hyg* **81**: 578-582.
- Talmi-Frank, D., Nasereddin, A., Schnur, L.F., Schonian, G., Toz, S.O., Jaffe, C.L. and Baneth, G. 2010. Detection and identification of Old World *Leishmania* by high resolution melt analysis. *PLoS Negl Trop Dis* **4**: E581.
- Tamura, K., Peterson, D., Peterson, N., Stecher, G., Nei, M. and Kumar, S. 2011. MEGA5: Molecular Evolutionary Genetics Analysis Using Maximum Likelihood, Evolutionary Distance, and Maximum Parsimony Methods. *Mol Biol Evol* **28**(10): 2731-2739.

- Thakur, C.P. and Kumar, K. 1992. Post kala-azar dermal leishmaniasis: A neglected aspect of kala-azar control programmes. *Ann Trop Med Parasitol* **86**: 355-359.
- Tibayrenc, M. 2005. Bridging the gap between molecular epidemiologists and evolutionists. *Trends in Microbiology* **13**: 575-580.
- Vaish, M., Bhatia, A., Reed, S.G., Chakravarty, J. and Sundar, S. 2012. Evaluation of rK28 antigen for serodiagnosis of visceral leishmaniasis in India. *Clin Microbiol Infect* **18**: 81-85.
- Van der Meide, W.F., Schoone, G.J., Faber, W.R., Zeegelaar, J.E., de Vries, H.J., Ozbel, Y., Lai, A., Fat, R.F., Coelho, L.I., Kassi, M. and Schallig, H.D. 2005. Quantitative nucleic acid sequence-based assay as a new molecular tool for detection and quantification of *Leishmania* parasites in skin biopsy samples. *J Clin Microbiol* **43**: 5560-5566.
- Vanloubbeeck, Y. and Jones, D. 2004. The immunology of *Leishmania* infection and the implications for vaccine development. *Ann N Y Acad Sci* **1026**: 267-272.
- Vanorshovan, B.A., Michielsen, P. and Vandepitte, J. 1979. Fatal leishmaniasis in renal transplant patient. *Lancet* **314**: 740-741.
- Villinski, J.T., Klena, J.D., Abbassy, M., Hoel, D.F., Puplampu, N., Mehta, S., Boakye, D. and Raczniak, G. 2008. Evidence for a new species of *Leishmania* associated with a focal disease outbreak in Ghana. *Diag Microbiol Infect Dis* **60**: 323-327.
- Wolday, D., Berhe, N., Akuffo, H., Desjeux, P. and Britton, S. 2001. Emerging *Leishmania*/HIV co-infection in Africa. *Med Microbiol Immunol* **190**: 65-67.

- World Health Organization. 1990. Control of the leishmaniasis. Report of a WHO Expert Committee. WHO Expert Committee on the Control of the Leishmaniasis, World Health Organization, Geneva, Switzerland.
- World Health Organization. 2004. Regional Strategic Framework for Elimination of Kala-azar from the South-East Asia Region (2005–2015). New Delhi: WHO Regional Office for South-East Asia.
- Wortman, G., Sweeney, C., Houg, H.S., Aronson, N., Stiteler, J., Jackson, J. and Ockenhouse, C. 2001. Rapid diagnosis of Leishmaniasis by fluorogenic polymerase chain reaction. *Am J Trop Med Hyg* **65**: 583-587.
- Zemanova, E., Jirku, M., Mauricio, I.L., Miles, M.A. and Lukes, J. 2004. Genetic poly- morphism within the *Leishmania donovani* complex: correlation with geographic origin. *Am J Trop Med Hyg* **70**: 613-617.
- Zemanova, E., Jirku, M., Mauricio, I.L., Horak, A., Miles, M.A. and Lukes, J. 2007. The *Leishmania donovani* complex: genotypes of five metabolic enzymes (ICD, ME, MPI, G6PDH, and FH), new targets for multilocus sequence typing. *Int J Parasitol* **37**: 149-160.
- Zijlstra, E.E., Ali, M.S., El-Hassan, A.M., el-Toum, I.A., Satti, M., Ghalib, H.W. and Kager, P.A. 1992. Kala-azar: a comparative study of parasitological methods and the direct agglutination test in diagnosis. *Trans R Soc Trop Med Hyg* **86**: 505-507.
- Zijlstra, E.E., Nur, Y., Desjeux, P., Khalil, E.A., El-Hassan, A.M. and Groen, J. 2001. Diagnosing visceral leishmaniasis with the recombinant K39 strip test: experience from the Sudan. *Trop Med Int Health* **6**: 108-113.
- Zijlstra, E.E., Musa, A.M., Khalil, E.A., El-Hassan, I.M. and El-Hassan, A.M. 2003. Post-kala-azar dermal leishmaniasis. *Lancet Infect Dis* **3**: 87-98.

Appendix - 1a

Patient

Data SheetGeneral informationID No. Date / / Name Age Yrs. Sex M / F

Father's / Husband's Name:

Address : Vill.

P.O.

P.S.

District.

Occupation:

Contact person with Tel. No.

Reg. no. Ward Bed Unit

Monthly income: Tk.

Clinical informationDuration of fever Weeks

Anaemia: Mild / Moderate / Severe

Loss of appetite: Yes / No

Loss of weight: Yes / No

Emaciation: Mild / Moderate / Severe

Blackening of skin: Yes / No

Bleeding: Yes / No

History of Kala azar among any family member: Yes / No

Spleen: Palpable / Not palpable (if palpable: cm. from the left costal margin)Liver: Palpable / Not palpable (if palpable: cm. from the left costal margin)Lymph node: Palpable / Not palpable (if palpable, specify:)

History of previous attack of Kala azar: No / Yes

(If yes, treatment for previous attack: Miltefosine / SAG / Dose: Duration: days,

Place of treatment: Hospital/Private chamber)

History of other illness:

Haemoglobin: gm/dl TC of WBC: N/↓/↑ Platelet count: N/↓/↑ ESR: mm.Prothrombin time: sec; INR: BT: min sec CT: min sec

Appendix - 1b

Patient

Laboratory findings

1. rK39 ICT : Positive / Negative
2. rK28 ICT : Positive / Negative
3. rK28 ELISA : Positive / Negative (OD :)
4. rK39 ELISA : Positive / Negative (OD :)
5. Splenic smear microscopy for LD body : Present / Absent
Parasitic Load: (Grade 1+ / 2+ / 3+ / 4+ / 5+ / 6+)
6. Buffy coat smear microscopy for LD body: Positive / Negative
7. Ln-PCR: Positive / Negative
8. LAMP : Positive / Negative
9. Mini-exon PCR : Positive / Negative
11. ITS-PCR: (a) ITS 1: Positive / Negative
(b) ITS 2: Positive / Negative
12. ITS1-RFLP genotyping:
13. ITS sequencing results:

Comment:

Investigator's signature

Appendix – 2a

Disease Control

Data SheetGeneral information

ID No. Date / /

Name Age Yrs. Sex M / F

Father's / Husband's Name:

Address : Vill. P.O. P.S.

District. Occupation:

Contact person with Tel. No.

Reg. no. Ward Bed Unit

Clinical information

Duration of fever Weeks

Anaemia: Yes / No (Mild / Moderate / Severe)

Loss of appetite: Yes / No

Loss of weight: Yes / No

Emaciation: Yes / No (Mild / Moderate / Severe)

Blackening of skin: Yes / No

Bleeding: Yes / No

History of Kala azar among any family member: Yes / No

Spleen: Palpable / Not palpable (if palpable: cm. from the left costal margin)

Liver: Palpable / Not palpable (if palpable: cm. from the left costal margin)

Lymph node: Palpable / Not palpable (if palpable, specify:)

History of previous attack of Kala azar: No / Yes

(If yes, treatment for previous attack: Miltefosine / SAG / Dose: Duration: days,

Place of treatment: Hospital/Private chamber)

Diagnosis of Disease:

Haemoglobin: gm/dl TC of WBC: N/↓/↑ Platelet count: N/↓/↑ ESR: mm.
 Prothrombin time: sec; INR: BT: min sec CT: min sec

Appendix - 2b

Disease Control

Laboratory findings

1. rK39 ICT : Positive / Negative
2. rK28 ICT : Positive / Negative
3. rK28 ELISA : Positive / Negative (OD:)
4. rK39 ELISA : Positive / Negative (OD:)
5. Buffy coat smear for LD body: Positive / Negative
6. Ln-PCR: Positive / Negative
7. LAMP : Positive / Negative
8. Mini-exon PCR : Positive / Negative
9. ITS-PCR: (a) ITS 1: Positive / Negative
(b) ITS 2: Positive / Negative

Comment:

Investigator's signature

Appendix – 3a

Endemic Control

Data Sheet**General information**

ID No. Date / / .

Name Age Yrs. Sex M / F

Father's / Husband's Name:

Address : Vill. P.O. P.S.

District. Occupation:

Contact person with Tel. No.

Reg. no. Ward Bed Unit

Clinical information

Fever Yes / No Weeks

Anaemia: Yes / No (Mild / Moderate / Severe)

Loss of appetite: Yes / No

Loss of weight: Yes / No

Emaciation: Yes / No (Mild / Moderate / Severe)

Blackening of skin: Yes / No

Bleeding: Yes / No

History of Kala azar among any family member: Yes / No

Spleen: Palpable / Not palpable (if palpable: cm. from the left costal margin)

Liver: Palpable / Not palpable (if palpable: cm. from the left costal margin)

Lymph node: Palpable / Not palpable (if palpable, specify:)

History of previous attack of Kala azar: No / Yes

(If yes, treatment for previous attack: Miltefosine / SAG / Dose: Duration: days,

Place of treatment: Hospital/Private chamber)

Appendix - 3b

Endemic Control

Laboratory findings

1. rK39 ICT : Positive / Negative
2. rK28 ICT : Positive / Negative
3. rK28 ELISA : Positive / Negative (OD:)
4. rK39 ELISA : Positive / Negative (OD:)
5. Buffy coat smear for LD body: Positive / Negative
6. Ln-PCR : Positive / Negative
7. LAMP : Positive / Negative
8. Mini-Exon PCR : Positive / Negative
9. ITS-PCR: (a) ITS 1: Positive / Negative
(b) ITS 2: Positive / Negative

Comment:

Investigator's signature

Appendix – 4a

Non-endemic Control

Data Sheet**General information**ID No. Date / / .Name Age Yrs Sex M / F

Father's / Husband's Name:

Address : Vill.

P.O.

P.S.

District.

Occupation:

Contact person with Tel. No.

Clinical informationFever Yes / No Weeks

Anaemia: Yes / No (Mild / Moderate / Severe)

Loss of appetite: Yes / No

Loss of weight: Yes / No

Emaciation: Yes / No (Mild / Moderate / Severe)

Blackening of skin: Yes / No

Bleeding: Yes / No

History of Kala azar among any family member: Yes / No

Spleen: Palpable / Not palpable (if palpable: cm. from the left costal margin)Liver: Palpable / Not palpable (if palpable: cm. from the left costal margin)Lymph node: Palpable / Not palpable (if palpable, specify:)

History of previous attack of Kala azar: No / Yes

(If yes, treatment for previous attack: Miltefosine / SAG / Dose: Duration: days,

Place of treatment: Hospital/Private chamber)

Appendix - 4b

Non-endemic Control

Laboratory findings

1. rK39 ICT : Positive / Negative
2. rK28 ICT : Positive / Negative
3. rK28 ELISA : Positive / Negative (OD:)
4. rK39 ELISA : Positive / Negative (OD:)
5. Buffy coat smear for LD body: Positive / Negative
6. Ln-PCR: Positive / Negative
7. LAMP : Positive / Negative
8. Mini-Exon PCR : Positive / Negative
9. ITS-PCR: (a) ITS 1: Positive / Negative
(b) ITS 2: Positive / Negative

Comment:

Investigator's signature

Appendix – 5

Preparation of leishman stain and staining procedure of smear (Chatterjee, 1980)

Leishman stain preparation

Ingredients

Leishman powder	: 0.15 g
Pure Methyl Alcohol (Methanol)	: 100 ml

Methyl alcohol was mixed gradually with Leishman's powder in a glass mortar to make a homogeneous mixture. It was then kept at 37°C for 24 hours and finally stored in a glass bottle for regular use.

Staining procedure

- a) The splenic smear and or buffy coat smears were first allowed to be air dried.
- b) The slides were placed over two parallel glass rods and then Leishman's stain was poured on to the smear.
- c) After 30 seconds the stain was diluted by adding twice its volume of distilled water.
- d) The diluted stain was kept for 15 minutes.
- e) The slides were washed with gentle flush of tap water and air dried keeping them in upright position.

Appendix - 6

Procedures for splenic aspiration (Bryceson, 1987)

Splenic aspiration was performed in admitted patients only after obtaining bleeding time (BT), clotting time (CT), prothrombin time (PT) and platelet count within permissive limits. The procedure was postponed in cases of prothrombin time more than 5 sec longer than that of the control, platelet count below 40,000/mm³ and abnormal BT or CT.

A tray containing following articles was placed at bedside before aspiration;

- 1) Three clean glass slides with proper labeling
- 2) A disposable plastic 5 mL syringe attached with a 1.25 inch x 21 gauge (32 x 0.8 mm) needle
- 3) Alcohol swab to clean the skin
- 4) Sterile cotton, gauge and micro pore strap

After explaining about the procedure written informed consent was taken from each patient or from guardian. The spleen was palpated and its margin was outlined on the patient's abdomen with a pen. The skin over the palpable spleen was cleaned with alcohol swab and allowed to dry.

With the needle attached to the 5 mL syringe the skin was penetrated midway between the edges of the spleen, 2-4 cm below the costal margin aiming the needle cranially at an angle of 45⁰ to the abdominal wall. The syringe plunger was pulled back to approximately the 1 mL mark to apply suction, and with a quick in-and-out movement the needle was pushed to the full needle depth and then withdrawn that completely maintaining suction throughout. The insertion of the needle was timed with the patient's breathing so that the diaphragm was not moving. The punctured site was strapped tightly by micro pore using cotton and gauge. Post-aspiration close monitoring of the patient for pulse and blood pressure was done by attending doctor for at least 8 hours.

Aspirated material was expelled gently on to glass slides, holding the needle tip on the surface of the slide. The materials were smeared quickly and evenly with the needle using a linear motion to make a thin film. The slides were allowed to be air dried. After staining in the laboratory the slides were examined under oil immersion lens for LD body.

Appendix - 7

Grading of parasites

(Chulay and Bryceson, 1983)

The parasite density in the splenic smear was graded according to the following table.

Grading of amastigotes in splenic smear

Grade	Average parasite density
6+	>100 parasites/ field*
5+	10-100 parasites/field
4+	1-10 parasites/field
3+	1-10 parasites/10 fields
2+	1-10 parasites/100 fields
1+	1-10 parasites/1000 fields
0	0 parasite/1000 fields

* Using 10 x eyepieces and 100 x oil-immersion lens

Appendix - 8**Preparation of reagents for ELISA**

(Cheesbrough, 1999)

1. Phosphate-buffered saline (PBS, pH - 7.3)*Stock phosphate solution A*

Sodium dihydrogen phosphate (NaH_2PO_4)	27.66 g
Distilled water	1000 ml

Stock phosphate solution B

di-Sodium hydrogen phosphate (Na_2HPO_4)	28.39 g
Distilled water	1000 ml

To prepare 200 ml:

Stock phosphate solution A	28 ml
Stock phosphate solution B	72 ml
Sodium chloride	1.7 g
Distilled water	100 ml

2. Blocking Buffer [1% Bovine serum albumin (BSA, pH 7.4)]

Phosphate-buffered saline (PBS)	500 ml
Bovine serum albumin (BSA)	5 g

3. 1 N Sulphuric Acid

Concentrated Sulphuric acid	14 ml
Distilled water	250 ml

Final volume was 500 ml.

4. Wash Solution (pH- 7.4)

1X PBS	1000 ml
Tween-20	0.5 ml

5. Serum Diluents (pH- 7.4)

1X PBS	500 ml
0.1% BSA	0.5 g
Tween 20	250 ml

6. Coating Buffer (pH - 9.6)

Sodium carbonate	1.6 g
Sodium bicarbonate	2.9 g
Distilled water	1000 ml

Conjugate preparation: 1.5 μ L of Goat Anti- Human IgG antibodies to 5.9985 mL sera (1/4000 dilution) in serum diluents.

Note: All the solutions were filtered through 0.2-0.45 mm pore size.

Appendix - 9

Buffy coat preparation

Concentration gradient separation by using Histopaque solution (Histopaque-1119; Sigma-Aldrich)

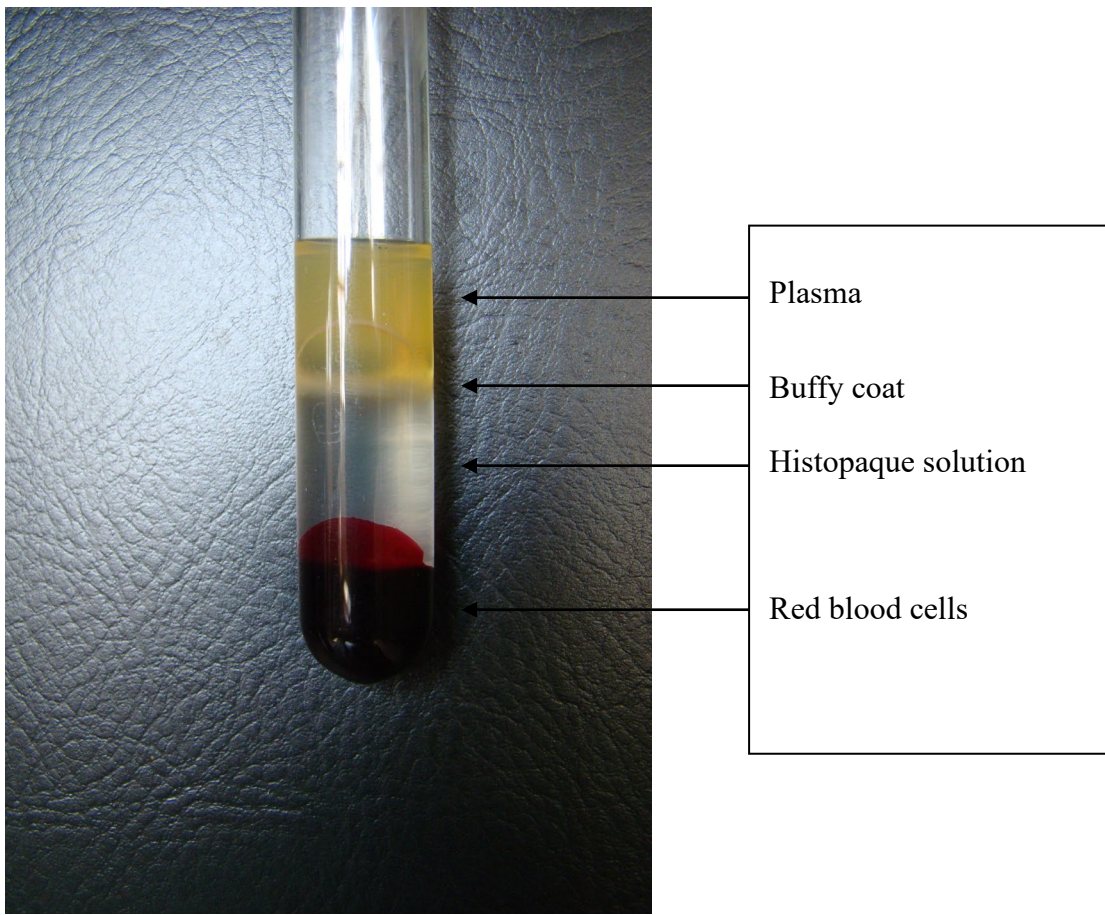

Appendix - 10

rK39 Immunochromatographic test

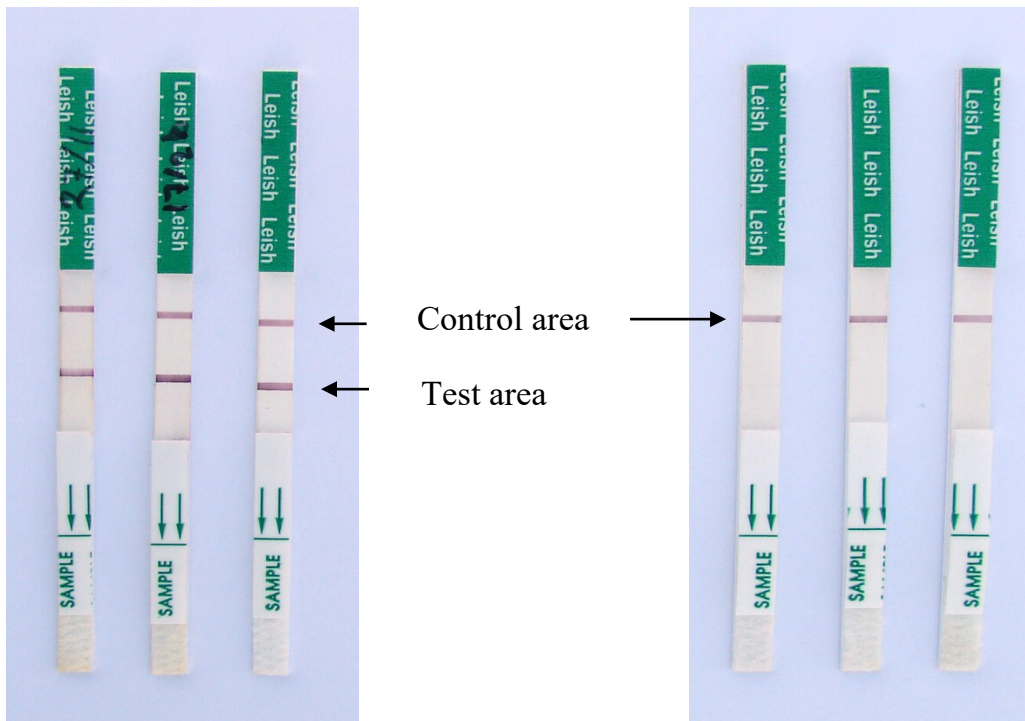

The test is considered positive with the appearance of two red lines (one in the control area and another in the test area)

The test is considered negative with the appearance of a single red line in the control area

Appendix -11

rK28 Immunochromatographic test

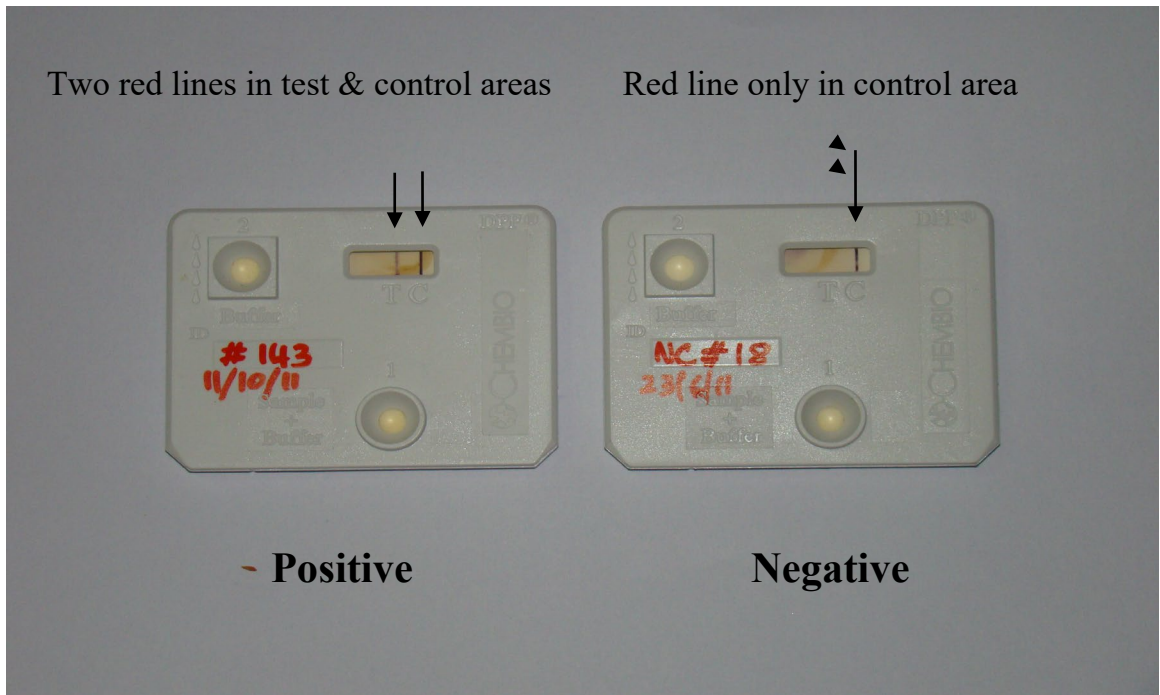

Appendix - 12

Microscopic view of LD bodies in spleen smear
(10x 100 magnification)

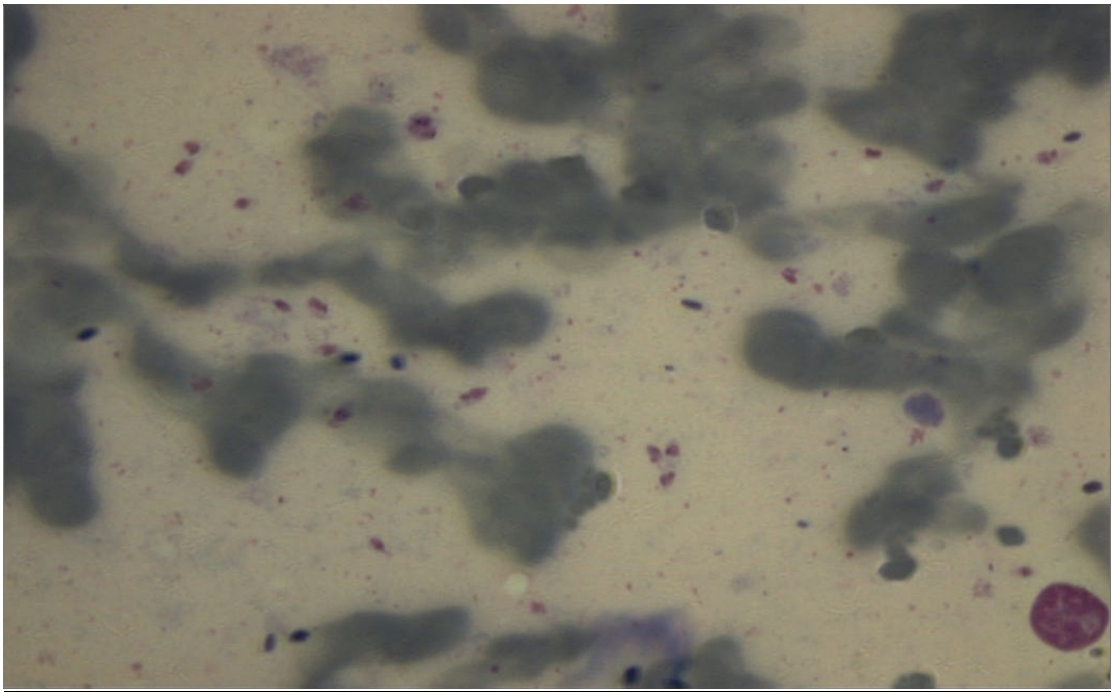

Appendix - 13

გვბტმუვეტყვჯ რხ უეფმ ივრკვნხ ტგმტკჯ კტჯ რ



მასჯი cI

ტი მხ

მტელ Yvi უკტი ბვგ t Kuj vRi მბვ³ კიტი Rb` j` ვეტი Uix ციქლი მგჰნი უეტი Y Ges ტჯ Bkg` უბგ
ტუტბვფბი ტრტბუბც I ტრტბუკ უბფვი მუი უბყი კიბ |
ცაბ მტელ ტკი ბვგ t Wt ტგტ Avajm მvj ვგ, მნთხ მხ Aa`vcK, გვბტმუვეტყვჯ რხ უეფმ, ივრკვნხ ტგმტკჯ
კტჯ რ |

მტელ Yv ცი Zôb t გვბტმუვეტყვჯ რხ უეფმ, ივრკვნხ ტგმტკჯ კტჯ რ I ც`ვი მმბტუჯ რხ j` ვეტი Uix,
AvB. m. w. w. w. Avi, we, გნლ Vj x, XvKv |

ფიგ Kv t ci Rwe ewnZ , iæZcy` ტი მგჰნი გტა` Kuj vRi Ab`Zg | AvmušI` ოჯ ტეტ გუი Kvgtoi
გრა`ტგ G ტი მ Qovq | მგვტ R AZ`š-` wi` ` RbtMvôxi გტა` B მრავი YZ G ტი მ Mi c`Kvc AwaK ნტი j` ო`
Kiv hvq | უეტი 6 ულ გნტ`ტი G ტი მ Mi c` f`e itqtQ thLvtb cI Z eQi cI q cI P j` ო` გუბ | Kuj vRi
AvmušI` nq Ges Zv` i gta` cI q 60,000 ტი vK გZ` yei Y Kti | Kuj vRi AvmušI` ტი მტ` i kZKiv 67
ფტი მ B emem ფი Z, evsj vt` k I tbcvtj | evsj vt` ტი ki 45 ულ ტრჯ ვგ G ტი მ მბვ³ Kiv ტმტ Q Ges
ივრკვნხ mn evsj vt` ტი ki tek KtqKw ტრჯ ვგ eQti i me მგტ Q B G ტი მ Mi c` f`e _vtK | Avgvt` i t` ტკ
eQti Kuj vRi AvmušI` ტი მ Xi msl`v Mto 7000-9000 Rb | მუკ ფტე ტი მ ბყე c`x`zi AcI Zj Zv I
მუკ რმვი A fite Kuj vRi AvmušI` ტი მტ` i A`ტტ KB გZei Y Kti | მ`cI Z ფი Z, evsj vt` k I tbcvtj
მი Kvi x ფტე Kuj vRi უბგ` Kgm`x Mh Y Kiv ნტტ Q Ges 2015 მტი j` gta` G ტი მ უბგ` j` j` ო` w` i Kiv
ნტტ Q |

მტელ Yvi D`i`k` t c`I weZ მტელ ბვგ Kuj vRi მბვ³ კიტი Rb` c`ოჯ Z უეფბეჯ` ვეტი Uix ციქლი e`ენვი
კტი ტი მ უბყი G mKj ციქლი მგჰნი h`_vh` ფიგ Kv Abjn`Uvb Kiv ნტე | ც`B DcvE` უეტი Y Kti მუკ ფტე
G ტი მ უბყი Rb` GKw WvqvMbvôK Gj` Mwi` `g` %Zix Kivi გრა`ტგ Avgvt` i t` ტკი უეფბეჩეტი ო`
tmev cI Zôv`bi Dc`thMx ციქლი c`I vebv Kiv ნტე | Kuj vRi c`EY epEi ივრკვნხ Gj`vKvi Kuj vRi
AvmušI` ტი მტ` i t`_ტკ c`B RxeYy`ტჯ Bkg` უბგv ტუტბვფბი ტრტბუბც I ტრტბუკ უბფვი მუი უბყი
Kiv ნტე |

ტკბ AvcბტK / Avcბvi უკი`ტკ GB მტელ Yvq AskMô`ბი Rb` Anevb Kiv ნტ`Q? t Avgiv Avcბvi მსუკ
მუკ რმტი კი გრა`ტგ Rvb`Z tcti`wQ th, Dbiv Avcბvi/Avcბvi უკი` i ტი მტკ c`I`wGK ფტე Kuj vRi მნმტე
ავი Yv Ki`ტბ | tm Rb` Avgiv AvcბტK/ Avcბvi უკი`ტკ Avgvt` i მტელ Yvq AskMô`ბი c`I`ve Kiv Q |

მტელ Yvi c`x`z t GB მტელ Yvq Avcბ/ Avcბvi უკი` Avgvt` i c`I`vტე მასჯი ntj ;

- 1 | Avcბ/ Avcბvi უკი` ო`ფეკ უბტტგ GB ნმცვ Z`ტჯ i c`ოჯ Z მუკ რმვი ცტებ |
- 2 | მტელ Yvi c`ოჯ რტბ AvcბტK/ Avcბvi უკი`ტკ AvmušI` ტი მ მ`ტუ უკოყც`კელ კვი მუი K ციქლი Kiv ნტე |
- 3 | მტელ ბვი უეტი ციქლი Rb` Avcბvi/ Avcბvi უკი` i უცონვ ტ`_ტკ უკბ მბტჯი მუნტ` Lp` მგვბ` (3-4
ტდუი) ცუი გვბ i`im, Ges ნტი Zi უკი v ტ`_ტკ 3 უგ. უj . i`im მსმ` Kiv ნტე |
- 4 | Avcბvi/ Avcბvi უკი` i უბკუ ნტი მსმ`xZ ბგბv i`agvI` მტელ Yvi D`i`k` eZ`ტბ Ges cieZ`xZ
ივრკვნხ ტგმტკჯ კტჯ რი გვბტმუვეტყვჯ რხ უეფმ Ges AvB. m. w. w. w. Avi, we- Gi ც`ვი მმბტუჯ რხ
j` ვეტი Uix`Z e`eüZ ნტე | Avgiv AvcბტK უბ`QZv w`w`Q th, მსმ`xZ i`im I უცონვი i`im GB მტელ Yv
Qov Ab` tKvb D`i`k` e`ენვი Kiv ნტე ბv |
- 5 | c`ოჯ რბხ ბგბv მსმ` Kivi ci Avcბ/ Avcბvi უკი` Kuj vRi c`KZB AvmušI` ნტტ Q უკბv Zv უებv
გტჯ` ციქლი გრა`ტგ Avgiv Rvb`ტე Ges Kuj vRi მბვ³ ntj Avcბ/ Avcბvi უკი` GB ნმცვ Z`ტჯ i c`ოჯ Z
მუკ რმვი tctZ`_vK`ტებ Ges Dch`³ მგტჯ ნმცვ Z`ტჯ ტ`_ტკ Qj` I` qv ნტე |

მტელ Yvq AskMô`ბი უეტი t AskMô`Y ბv Kiv B მტელ Yvq AskMô`ბი უეტი |

MtelYvq AskMh̄t̄bi S̄K t̄ w̄c̄onv n̄Z i³ msM̄ni mgq m̄Pi mvgv̄b̄ ē_v Ges cti t̄ct̄Ui Af̄š̄f̄i i³ q̄īt̄Yi q̄x̄Y m̄v̄ebv _v̄K| G ēvc̄v̄ti c̄Ńq̄vRbxq c̄ŃK-cix̄q̄v (thgb, i³cv̄t̄Zi mgq, i³ RgvU ev̄avi mgq, Ab̄P̄m̄Kvi msL̄v) mḡf̄ni gvātg Avcbvi / Avcbvi w̄ki i Dch̄ȳZv _v̄Kt̄j B t̄Kej gv̄I w̄c̄onv n̄Z i³ msM̄ni Kiv n̄t̄e| w̄c̄onv n̄Z i³ msM̄ni ci m̄v̄ē me iKg S̄K Gov̄t̄Z b̄p̄Zg 8 N̄Uv Avcb̄t̄K/ Avcbvi w̄ki t̄K Wv̄³v̄t̄i i v̄b̄w̄eo Z̄Ēȳav̄t̄b̄ i v̄Lvi v̄b̄Ńq̄Zv w̄w̄Q| w̄kiv n̄Z i³ msM̄ni t̄q̄t̄I mvgv̄b̄ ē_v I Bb̄t̄dKk̄t̄bi q̄x̄Y m̄v̄ebv _v̄K| m̄v̄ē S̄K Gov̄t̄Z Avgiv R̄x̄ev̄y ḡj̄ m̄P I w̄M̄t̄c̄w̄mej w̄m̄i Ä ēenv̄t̄i i v̄b̄Ńq̄Zv c̄Ńv̄b̄ Kiw̄Q|

MtelYvq AskMh̄t̄bi DcKwi Zv t̄ GB MtelYvq AskMh̄t̄bi d̄t̄j Avcbvi / Avcbvi w̄ki i Kvj v̄R̄j̄ n̄t̄q̄t̄Q w̄Kbv t̄m ēvc̄v̄ti Avgv̄t̄ i v̄b̄w̄ŃZ cix̄q̄vi d̄j v̄d̄j R̄v̄t̄Z cv̄īt̄ev̄ hv̄ Avcbvi w̄P̄w̄K̄rmv c̄Ńv̄t̄bi t̄q̄t̄I m̄nv̄q̄Zv Kīt̄e| Zv̄Q̄rov Avcbvi / Avcbvi w̄ki i AskMh̄t̄bi gvātg msM̄nx̄Z Z_ Dcv̄Ē cieZ̄x̄Z̄ Kvj v̄R̄j̄ w̄v̄b̄q̄ j̄v̄et̄i Uix̄ cix̄q̄vi w̄ew̄fb̄w̄ K I G t̄i v̄t̄Mi R̄x̄ev̄Ym̄v̄t̄Ń Av̄M̄h̄x̄ Ab̄j̄n̄Ūvb̄Kvīt̄ i v̄ēĪw̄i Z̄ R̄v̄bi m̄t̄h̄M̄ m̄j̄Ń Kīt̄e|

Z̄t̄_i t̄M̄v̄cb̄x̄Zv t̄ MtelYvi Ges MtelYvq AskMh̄t̄bi Kvīxi m̄Kj Z_ v̄ej̄x̄ c̄Ńv̄b̄ Mtel̄t̄Ki v̄b̄q̄š̄t̄b̄ Z̄vj̄ v̄ex̄ Aē_v̄q̄ m̄si q̄l̄b̄ Kiv n̄t̄e| Gme Z_ GB MtelYvi Mtel̄K Ges Z̄vi Z̄Z̄ȳav̄b̄Kvīx̄ ē_w̄ZZ̄ Ab̄ t̄KD t̄L̄t̄Z cv̄īt̄eb̄ bv̄| MtelYvi d̄j c̄Ńv̄t̄ki mgq t̄Kv_vl Avcbvi / Avcbvi w̄ki i b̄vg w̄K̄sev c̄w̄i Pq̄ D̄t̄j ŃL_v̄K̄t̄e bv̄|

q̄w̄Z̄c̄īb̄ t̄ MtelYvq AskMh̄t̄bi Rb̄ Avcb̄t̄K t̄Kvb̄ LiP̄ enb̄ Kīt̄Z̄ n̄t̄e bv̄ w̄K̄sev Avcb̄t̄Kl̄ t̄Kvb̄ A_ R̄w̄o t̄l̄q̄v n̄t̄e bv̄| w̄c̄onv n̄Z i³ msM̄ni Rb̄ t̄ct̄Ui Af̄š̄f̄i i³ q̄īY I i³ t̄iv̄M̄-R̄x̄ev̄y m̄s̄p̄ḡt̄bi q̄x̄Y m̄v̄ebvi Kvīt̄Ȳ h̄w̄ t̄Kvb̄ D̄w̄Z̄ c̄w̄i w̄w̄Z̄ m̄j̄Ń nq̄ Z̄v̄n̄t̄j Avgv̄t̄ i Līt̄P̄ D̄ct̄iv̄³ m̄gm̄vi ēvs̄j̄ v̄t̄ t̄k̄ m̄v̄ē Ggb̄ w̄P̄w̄K̄rmv̄ Kīv̄t̄b̄vi w̄w̄q̄Z̄i Avgiv̄ enb̄ Kīt̄ev̄| GQ̄rov̄ Av̄i t̄Kvb̄ aīt̄bi q̄w̄Z̄c̄īb̄ ev̄ m̄j̄eav̄ w̄ t̄Z̄ Avgiv̄ Ac̄vi M̄Z̄v̄ R̄v̄b̄w̄Q|

MtelYv t̄t̄K̄ c̄Ńv̄v̄t̄i i Av̄āKvi t̄ īaȳgv̄I Av̄c̄v̄B̄ GB MtelYvq Avcbvi / Avcbvi w̄ki i AskMh̄t̄bi c̄t̄q̄ w̄m̄x̄v̄š̄I t̄bevi Av̄āKvīx̄| AskMh̄t̄bi m̄v̄š̄Z̄ t̄ev̄i c̄t̄i I MtelYvi th̄ t̄Kvb̄ ch̄q̄q̄ t̄Kvb̄ iK̄t̄gi q̄w̄Z̄c̄īY Q̄rov̄B̄ Av̄c̄v̄ Avcbvi m̄v̄š̄Z̄ c̄Ńv̄v̄ni Kīt̄Z̄ cv̄īt̄b̄| MtelYvq AskMh̄t̄bi v̄v̄ Kīt̄j̄ Ggb̄w̄K̄ AskMh̄t̄bi ci m̄v̄š̄Z̄ c̄Ńv̄v̄ni Kīt̄j̄ I Av̄c̄v̄ ev̄ Avcbvi w̄ki i v̄R̄k̄v̄nx̄ t̄gm̄w̄t̄Kj̄ K̄t̄j̄ R̄ n̄v̄m̄cv̄Z̄t̄j̄ i c̄Ńw̄j̄ Z̄ t̄m̄ev̄ w̄K̄ Av̄t̄Mi ḡZ̄B̄ t̄ct̄Z̄_v̄K̄t̄eb̄|

Avcbvi Av̄āKvi I v̄R̄Á̄mv̄ t̄ GB MtelYvi ēvc̄v̄ti Avcbvi t̄Kvb̄ c̄Ńv̄v̄K̄t̄j̄ Avgiv̄ Z̄vi h_vh_ D̄Ēi t̄t̄ev̄| cieZ̄x̄Z̄I Av̄c̄v̄ Avgv̄t̄ īt̄K̄ c̄Ńv̄t̄Kīt̄Z̄ cv̄īt̄eb̄ Ges GB MtelYvi c̄Ńv̄b̄ Mtel̄K̄ Wrt̄ t̄gv̄t̄ Av̄ā̄j̄n̄ m̄j̄v̄t̄gi m̄v̄t̄_ i v̄R̄k̄v̄nx̄ t̄gm̄w̄t̄Kj̄ K̄t̄j̄ t̄R̄ī gv̄B̄t̄j̄v̄ev̄t̄q̄j̄ R̄x̄ w̄ef̄v̄t̄M̄ w̄M̄t̄q̄ A_ev̄ 810983 (Av̄d̄m); 01916089071 (t̄gv̄ev̄t̄) t̄Ūw̄j̄ t̄d̄v̄t̄b̄ th̄M̄t̄h̄M̄ K̄t̄i D̄Ēi t̄ct̄Z̄ cv̄īt̄b̄|

m̄v̄š̄Z̄ I t̄N̄v̄I Yv̄ t̄ Av̄c̄v̄ GB MtelYvq Avcbvi / Avcbvi w̄ki i AskMh̄t̄b̄ Avgv̄t̄ i c̄Ńv̄t̄ē i v̄R̄x̄_v̄K̄t̄j̄ v̄b̄t̄Pi v̄b̄w̄īŃ v̄t̄b̄ v̄q̄ī A_ev̄ w̄Ūcm̄B̄ w̄b̄| Avcbvi v̄q̄ī GB A_ enb̄ K̄t̄i th̄ Av̄c̄v̄ GB MtelYvi D̄t̄īk̄, c̄x̄w̄Z̄, S̄K̄ I j̄v̄f̄, AskMh̄t̄bi w̄eK̄I Ges MtelYvq AskMh̄t̄ȲKvīx̄ w̄m̄v̄t̄ē Avcbvi / Avcbvi w̄ki i KīȲx̄q̄ I Av̄āKvi m̄v̄t̄Ń w̄ēĪw̄i Z̄ t̄R̄t̄b̄ m̄v̄b̄Ńv̄t̄ē ēt̄S̄ Avcbvi m̄v̄š̄Z̄ c̄Ńv̄b̄ Kīt̄Q̄b̄|

Avcbvi m̄n̄t̄h̄M̄Z̄vi Rb̄ ab̄ev̄ |

AskMh̄t̄ȲKvīx̄ / Av̄f̄f̄v̄et̄Kī v̄q̄ī A_ev̄ ev̄ḡ ēx̄v̄s̄_t̄j̄ i w̄Ūcm̄B̄ Z̄w̄i Lt

Mtel̄K̄ / c̄ŃZ̄v̄b̄w̄ai v̄q̄ī Z̄w̄i Lt

v̄q̄ī v̄q̄ī Z̄w̄i Lt

Appendix - 14



გვბტμვეტყvj Rx we fWM
ivRkvnX tgvMტKj Kტj R

მასჟZ cĭ

ტიMx-KტUტj

მტელYvi vტიvბvg t Kvj vRჲi მბv³ KiჲYi Rb" j"ვეტიUix cixჲjv mgჲni ვეტიKY Ges ტj Bkg"wbqv
tWტbvfwbi tRტbUvBc I tRტbUk WbFvi vmiU vbYჲKib|
cĭvb მტელტიKi ბvg t Wt tgvT Avĭjn mvj vg, mnthMx Aa"vcK, გვბტμვეტყvj Rx we fWM, ivRkvnX tgvMტKj
Kტj R |

მტელYv cĭZōvb t გვბტμვეტყvj Rx we fWM, ivRkvnX tgvMტKj Kტj R I c"vi vmbტUvj Rx j"ვეტიUix,
AvB.ᄡ.ᄡ.ᄡ.ᄡ.Avi ,we, გრVLvj x, XvKv|

ფvgKv t ciRwe ewnZ ,iaZcYჲivM mgჲni gტa" Kvj vRჲi Ab"Zg| Avμvšĭ ᄡ tetj გvQi Kvgტoi
გvატg G tivM Qovq| mgvტR AZ"š-`wi`RbტMvōxi gტa" B mvaY Z G tivტMi cĭKvc AwaK nტი j ᄡ
Kiv hvq| ვეტიK 6 ᄡ gnvტ`tk G tivტMi cĭ fჲe itტტQ thLvtb cĭZ eQi cĭq cP j ᄡ გvb| Kvj vRჲi
Avμvšĭ nq Ges Zvტ`i gტa" cĭq 60,000 ტj vK gZ"yeiY Kტი | Kvj vRჲi Avμvšĭ ტivMტ`i kZKiv 67
fტიMiB emevm fvi Z, evsj vტ`k I tbcvტj | evsj vტ`tki 45 ᄡ tRj vq G tivM მბv³ Kiv tMტQ Ges
ivRkvnX mn evsj vტ`tki tek KტqKᄡU tRj vq eQტი i me mgტqB GB tivტMi cĭ fჲe vტK| Avgvტ`i t`tk
eQტი Kvj vRჲi Avμvšĭ ტivMxi msl"v Mტo 7000-9000 Rb| mᄡKfvტe tivMvbYჲ cx"zi AcĭZj Zv I
mᄡKrmvi Afvტe Kvj vRჲi Avμvšĭ ტivMტ`i AტბKB გZeiY Kტი | mაცĭZ fvi Z, evsj vტ`k I tbcvტj
mi KviX fvტe Kvj vRჲi vbgჲ KგᄡPx MᄡY Kiv nტტQ Ges 2015 mტი j gტa" G tivM vbgჲj i j ᄡ w"i Kiv
nტტQ|

მტელYvi Dტი"K" t cĭf weZ მტელbvq Kvj vRჲi მბv³KiჲYi Rb" cჲuj Z wefბეj"ვეტიUix cixჲjv e"envi
Kტი tivM vbYჲq G mKj cixჲjv mgჲni h_vh_ ფvgKv AbjnUvb Kiv nტი | cĭB DcvE ვეტიKY Kტი mᄡKfvტe
G tivM vbYჲq Rb" GKᄡU WvqvMბvōK Gj ტMwi`g %Zix Kivi გvატg Avgvტ`i t`tki wefბეchჲqi ᄡ
tmev cĭZōvტი DcტიMx cixჲjvi cĭf vebv Kiv nტი | Kvj vRჲi cჲY epEi ivRkvnX Gj vKvi Kvj vRჲი
Avμvšĭ ტivMტ`i t`tk cĭB RxeYyტj Bkg"wbqv tWტbvfwbi tRტbUvBc I tRტbUk WbFvi vmiU vbYჲ
Kiv nტი |

ტიKb AvcbvტK / Avcbvi vტიტიK GB მტელYvq AskMᄡტი Rb" Avnevბ Kiv nტი? t Avgiv Avcbvi mსიკó
vᄡKrmტიKi გvატg RvbტიZ tტიiQ th, Avcbv/Avcbvi vტი
tivტM fMტიQ| cĭf weZ მტელYvi dj vდj mᄡK fvტe ვეტიKb Kivi jტი ᄡ KტUტj vnmტი Ask MᄡY Kivi
Rb" Avgiv AvcbvტK/ Avcbvi vტიტიK cĭf ve Kiv Q|

მტელYvi cx"z t GB მტელYvq Avcbv/ Avcbvi vტი Avgvტ`i cĭf vტe mასZ nტი ;

- 1| Avcbv/ Avcbvi vტი ᄡfweK vbqტg GB nvmcvZტი j i cჲuj Z vᄡKrmv cvტeb|
- 2| მტელYvi cĭqvRტი AvcbvტK/ Avcbvi vტიტიK Avμvšĭ ტivM mაცU vKQycKael kvixii K cixჲjv Kiv nტი |
- 3| მტელbvi ვეტიK cixჲjvi Rb" Avcbvi/ Avcbvi vტი i nტიZi vტიv tტიK 3 vგ.uj . i³ mსMᄡ Kiv nტი |
- 4| Avcbvi/ Avcbvi vტიi vbKU nტი mსMnxZ bgbv i agvĭ მტელYvi Dტი"tk eZჲvტი Ges cieZჲZ
ivRkvnX tgvMტKj KტიტიRi გვბტμვეტყvj Rx we fWM Ges AvB.ᄡ.ᄡ.ᄡ.ᄡ.Avi ,we-Gi c"vi vmbტUvj Rx
j"ვეტიUixტი e"eÜZ nტი | Avgiv AvcbvტK vbōqv v w"Q th, mსMnxZ i³ GB მტელYv Qvov Ab" ტKvb
Dტი"tk" e"envi Kiv nტი bv|
- 5| cĭqvRტი bgbv mსMᄡ Kivi ci Avcbv/Avcbvi vტი GB nvmcvZტი i cჲuj Z vᄡKrmv tტიZ vKტeb
Ges Dchჲ³ mgტიq nvmcvZტი tტიK QᄡU t` I qv nტი |

მტელYvq AskMᄡტი vეKი t AskMᄡY bv KivB მტელYvq AskMᄡტი vეKი |

MtelYvq AskMh̄tbi S̄K t wkiv n̄Z i³ msM̄ni t̄ŋt̄ mv̄gb̄ e² v̄ I Bb̄tdKk̄tbi ŋ̄xY m̄ŋebv̄ _v̄tK | m̄ŋe² S̄K Gov̄tZ Avgiv R̄xevbyḡ³ m̄P I w̄M̄t̄c̄w̄mej w̄m̄i Ā e² en̄v̄t̄i i w̄b̄ōqZv̄ c̄ōvb̄ Kīw̄Q |

MtelYvq AskMh̄tbi DcKwi Zv̄t GB MtelYvq Avcbvi / Avcbvi w̄ki i AskMh̄tbi d̄tj msM̄n̄Z Z² Dcv̄Ē Kvj v̄R̄j w̄Yb̄ŋq j² v̄eti Uix̄ cix̄ŋ̄vi w̄w̄f̄b̄w̄ K f̄v̄tj v̄f̄v̄te Rv̄bevi m̄ŋh̄v̄M m̄yō Kīte |

Z̄t² i t̄M̄v̄cb̄qZv̄t MtelYvi Ges MtelYvq AskMh̄bKvixi m̄Kj Z² v̄ej x̄ c̄āvb̄ Mtel̄t̄Ki w̄bq̄ŋ̄b̄ Zvj v̄ex̄ Ae² v̄q m̄si ŋ̄b̄ Kiv̄ n̄te | Gme Z² GB MtelYvi Mtel̄K Ges Zui ZZ̄ȳeav̄bKvix̄ e² w̄ZZ̄ Ab̄ t̄KD t̄ L̄t̄Z̄ cv̄īteb̄ bv̄ | MtelYvi dj̄ c̄K̄v̄t̄ki mgq̄ t̄Kv̄_vl̄ Avcbvi / Avcbvi w̄ki i b̄vḡ w̄Ksev̄ cv̄i Pq̄ D̄tj̄ øL̄ _v̄K̄tē bv̄ |

ŋ̄w̄Zc̄ib̄ t̄ MtelYvq AskMh̄tbi Rb̄ Avcbv̄t̄K t̄Kvb̄ LiP̄ enb̄ Kīt̄Z̄ n̄tē bv̄ w̄Ksev̄ Avcbv̄t̄Kl̄ t̄Kvb̄ A₂ R̄w̄o t̄ l̄qv̄ n̄tē bv̄ | i³ t̄iv̄M-R̄x̄ev̄b̄ȳms̄p̄ḡt̄bi ŋ̄x̄Y m̄ŋeb̄vi Kvīt̄Ȳ h̄w̄ t̄Kvb̄ D² c̄w̄i w̄w̄Z̄ m̄yō nq̄ Zv̄n̄t̄j̄ Avgv̄t̄ i Līt̄P̄ Dc̄t̄iv̄³ m̄gm̄vī ev̄sj̄v̄t̄ ŋ̄k̄ m̄ŋē Ggb̄ w̄P̄w̄K̄rmv̄ Kiv̄t̄b̄vi w̄w̄q̄Z̄j̄ Avgiv̄ enb̄ Kītēv̄ | GQ̄rov̄ Av̄i t̄Kvb̄ aīt̄bi ŋ̄w̄Zc̄ib̄ ev̄ m̄ȳeav̄ w̄ t̄Z̄ Avgiv̄ Ac̄viM̄Z̄v̄ Rv̄bw̄²Q |

MtelYv̄ t̄_t̄K̄ c̄Ŵ² v̄n̄v̄t̄i i Āw̄Kvi t̄ īaȳgv̄Ā Avcb̄B̄ GB MtelYvq Avcbvi / Avcbvi w̄ki i AskMh̄tbi c̄t̄ŋ̄ w̄m̄x̄v̄Ŵ̄ t̄bevi Āw̄Kvix̄ | AskMh̄tbi m̄ŋŴ̄Z̄ t̄² ev̄i c̄t̄i l̄ MtelYvi th̄ t̄Kvb̄ ch̄ŋ̄q̄ t̄Kvb̄ iK̄t̄gi ŋ̄w̄Zc̄iȲ Q̄iv̄v̄B̄ Avcb̄ Avcbvi m̄ŋŴ̄Z̄ c̄Ŵ² v̄n̄vī Kīt̄Z̄ cv̄īb̄ | MtelYvq AskMh̄Ȳ bv̄ Kīt̄j̄ Ggb̄w̄K̄ AskMh̄tbī cī m̄ŋŴ̄Z̄ c̄Ŵ² v̄n̄vī Kīt̄j̄ l̄ Avcb̄ ev̄ Avcbvi w̄ki i v̄R̄k̄v̄n̄x̄ t̄ḡw̄Ŵ̄t̄Kj̄ K̄t̄j̄ R̄ n̄v̄m̄cv̄Z̄t̄j̄ i c̄Ŵ̄vj̄ Z̄ t̄nev̄ w̄K̄ Av̄t̄Mī ḡZB̄ t̄c̄t̄Z̄ _v̄K̄tēb̄ |

Avcbvi Āw̄Kvi I w̄R̄Ā̄m̄v̄ t̄ GB MtelYvi e² v̄c̄v̄t̄i Avcbvi t̄Kvb̄ c̄k̄e² v̄K̄t̄j̄ Avgiv̄ Zvi h̄_vh̄_ DĒi t̄² tev̄ | cieZ̄ŋ̄Z̄I Avcb̄ Avgv̄t̄ īt̄K̄ c̄k̄e² Kīt̄Z̄ cv̄īteb̄ Ges GB MtelYvi c̄āvb̄ Mtel̄K̄ Wrt̄ t̄gv̄t̄ Av̄ā̄j̄n̄ m̄vj̄ v̄t̄gī m̄v̄t̄_ i v̄R̄k̄v̄n̄x̄ t̄ḡw̄Ŵ̄t̄Kj̄ K̄t̄j̄ t̄Rī gv̄B̄t̄p̄v̄ev̄t̄q̄j̄ Rx̄ w̄ef̄v̄t̄M̄ w̄M̄t̄q̄ A₂ ev̄ 810983 (Āw̄dm̄); 01916089071 (t̄gv̄ev̄t̄) t̄Ūwj̄ t̄d̄v̄t̄b̄ th̄w̄ŋ̄t̄h̄v̄M̄ K̄t̄i DĒi t̄c̄t̄Z̄ cv̄īb̄ |

m̄ŋŴ̄Z̄ I t̄N̄vl̄Yv̄ t̄ Avcb̄ GB MtelYvq Avcbvi / Avcbvi w̄ki i AskMh̄t̄b̄ Avgv̄t̄ ī c̄Ŵ̄Ŵ̄v̄tē i v̄Rx̄ _v̄K̄t̄j̄ w̄b̄t̄Pī w̄b̄w̄ī ŋ̄ v̄t̄b̄ v̄ŋ̄ŋ̄i A₂ ev̄ w̄Ūcm̄B̄ w̄ b̄ | Avcbvi v̄ŋ̄ŋ̄i GB A₂ en̄b̄ K̄t̄i th̄ Avcb̄ GB MtelYvi D̄t̄Ŵ̄k̄, c̄x̄w̄Z̄, S̄K̄ I j̄ v̄f̄, AskMh̄t̄bī w̄eK̄Ŵ̄ Ges MtelYvq AskMh̄ȲKvix̄ w̄n̄m̄v̄tē Avcbvi / Avcbvi w̄ki i KīYx̄q̄ I Āw̄Kvi m̄ŋt̄Ŵ̄ w̄e² Ŵ̄w̄i Z̄ t̄R̄t̄b̄ m̄ŋŴ̄b̄ŋ̄v̄tē ēt̄S̄ Avcbvi m̄ŋŴ̄Z̄ c̄ōvb̄ Kīt̄Q̄b̄ |

Avcbvi m̄ŋt̄h̄w̄M̄Z̄vi Rb̄ ab̄² ev̄ |

AskMh̄ȲKvix̄ / Av̄f̄f̄v̄ēt̄K̄i v̄ŋ̄ŋ̄i A₂ ev̄ eiḡ e² x̄v̄s̄, t̄j̄ i w̄Ūcm̄B̄ Zv̄i Lt

Mtel̄K̄ / c̄ōZ̄v̄b̄w̄ai v̄ŋ̄ŋ̄i Zv̄i Lt

v̄ŋ̄ŋ̄i v̄ŋ̄ŋ̄i Zv̄i Lt

Appendix - 15



გვბტმუვეტყვ Rx wefM
ivRkvnx tgvMტKj Kტj R

მასშZ ცI

GbტWvgK-KტUტj

MტelYvi wტtivbvgt Kvj vRტj mbv³ KiტYi Rb³ j³vetiUix cix³qv mgტni wტkIY Ges tj Bkg³wbqv
tWტbvfwbi tRტbvUvBc I tRტbvUK WvBfviwmuU wBY³Qib|
c³avb MტelტKi bvgt Wwt tgv Av³ajm mvj vg, mnthMx Aa³vck, გვბტმუვეტყვ Rx wefM, ivRkvnx tgvMტKj
Kტj R |

MტelYv c³z³ovb t გვბტმუვეტყვ Rx wefM, ivRkvnx tgvMტKj Kტj R I c³viwvBტUტj Rx j³vetiUix,
AvB.wm.wv.wv.Avi we, გvLvj x, XvKv|

fvgtv t ciRwe ewnz ,iaZcY³tiw mgტni gტa³ Kvj vRტj Ab³Zg| Av³uv³š³ ო³ tetj gwQi Kvgtoi
gva³tg G tiw Qovq| mgvტR AZ³š-³wi³ Rb³τMv³xi gტa³B maviYZ G tiwMi c³QKvc AwaK nტი j³Q³
Kiv hvq| wტk| 6 wJ gnv³ტk G tiwMi c³ f³le itqtQ thLvtb c³Z eQi c³q c³up j³Q gvby Kvj vRტj
Av³uv³š³ nq Ges Zv³ i gტa³ c³q 60,000 tj vK gZ³yeiY Kტი | Kvj vRტj Av³uv³š³ tiwM³ i kZKiv 67
fvტMiB emem fviZ, evsj³ v³ k I tbcv³ტj | evsj³ v³ ტki 45 wJ tRjvq G tiwM mbv³ Kiv tM³Q Ges
ivRkvnx mn evsj³ v³ ტki tek KტqKwJ tRjvq eQ³ii me mgტqB GB tiwMi c³ f³le v³ტk| Avgv³ i t³ტk
eQ³i Kvj vRტj Av³uv³š³ tiwM³ msL³v M³to 7000-9000 Rb| mwKfv³te tiwM³by³ c³x³zi Ac³Zj Zv I
m³pvKrmvi Afv³te Kvj vRტj Av³uv³š³ tiwM³ i At³ტKB gZ³eiY Kტი | m³c³z³ fviZ, evsj³ v³ k I tbcv³ტj
miKvix fv³te Kvj vRტj wbg³ Kgm³px M³ay Kiv nტqtQ Ges 2015 m³ტj i gტa³ G tiwM wbg³ i j³Q³ w³i Kiv
nტqtQ|

MტelYvi D³τ³k³ t c³ I weZ Mტelbvq Kvj vRტj mbv³ KiტYi Rb³ c³Q³uj Z wef³bej³ vetiUix cix³qv e³envi
Kტი tiwM wBY³q G mKj cix³qv mgტni h³v³ fvgtv Ab³ynUvb Kiv nტი | c³τB Dcv³E wტkIY Kტი mwKfv³te
G tiwM wBY³q³ Rb³ GKwJ WvqvMbv³ok Gj³τ³mw³ g³ %Zix Kivi gva³tg Avgv³ i t³ტki wef³b³ach³q³ i³τ³
tmev c³z³ov³τbi Dc³thMx cix³qv³ c³ I vebv Kiv nტი | Kvj vRტj c³Y ep³Ei ivRkvnx Gj³vKvi Kvj vRტj
Av³uv³š³ tiwM³ i t³ტk c³τB RxeYy³τj Bkg³wbqv tWტbvfwbi tRტbvUvBc I tRტbvUK WvBfviwmuU wBY³
Kiv nტი |

ტKb Avcb³ტK / Avcbvi w³ki³ტK GB MტelYvq AskM³τ³bi Rb³ Avneb Kiv n³Q? t Avcb/Avcbvi w³ki³
Kvj vRტj c³ f³le Gj³vKvq emem Kტიb Rv³ტZ t³cti c³ I weZ MტelYvi dj³v³dj m³VK fv³te wტkIb Kivi
j³τ³ KტUტj wnm³te Ask M³ay Kivi Rb³ Avgiv Avcb³ტK/ Avcbvi w³ki³ტK c³ I ve Kiv Q|

MტelYvi c³x³z³ t GB MტelYvq Avcb/ Avcbvi w³ki³ Avgv³ i c³ I v³te m³sz³ n³τj ;

- 1| Avcb/ Avcbvi w³ki³ ო³fv³weK w³bq³τg GB n³mcvZ³τj i c³Q³uj Z w³pvKrmv c³τeb |
- 2| MტelYvi c³Q³vr³ტb Avcb³ტK/ Avcbvi w³ki³ტK Av³uv³š³ tiwM m³τ³U w³KQyc³kel kvix³xi K cix³qv Kiv nტი |
- 3| Mტelbvi w³ტkl cix³qv³ Rb³ Avcbvi/ Avcbvi w³ki³ i n³τzi w³ki³ t³ტk 3 w³g.wj . i³ msM³h Kiv nტი |
- 4| Avcbvi/ Avcbvi w³ki³ i w³KU n³τz msM³pxZ bg³pv i³agv³τ MტelYvi D³τ³k eZ³qv³τb Ges cieZ³τZ
ivRkvnx tgvMტKj Kტj³τ³ri გვბტმუვეტყვ Rx wef³τM Ges AvB.wm.wv.wv.Avi we-Gi c³viwvBტUტj Rx
j³vetiUix³ e³e³uZ nტი | Avgiv Avcb³ტK w³o³q³Zv w³w³Q th, msM³pxZ i³ GB MტelYv Qov³ Ab³ t³Kvb
D³τ³k³ e³envi Kiv nტი bv |

5| c³Q³vr³bxq bg³pv msM³h Kivi ci Avcb/Avcbvi w³ki³ GB n³mcvZ³τj i c³Q³uj Z w³pvKrmv t³ctZ v³K³teb
Ges Dch³τ³ mg³τq n³mcvZ³τj t³ტk Q³U t³ I qv nტი |

Mtel Yvq AskMh̄tbi weKí t AskMh̄Y bv KivB Mtel Yvq AskMh̄tbi weKí |

Mtel Yvq AskMh̄tbi S̄K t w̄kiv n̄Z i³ msM̄ni t̄ŋj̄t̄ mvgv̄b̄ ē_v I Bb̄tdKk̄tbi ŋj̄Y m̄ə̄ebv _v̄tK |
m̄ə̄ē S̄K Gov̄tZ Avgiv R̄xevbyḡ³ mP I w̄M̄t̄cw̄mej w̄wi Ā ēenv̄t̄i i w̄b̄ōqZv c̄ō vb Ki uQ |

Mtel Yvq AskMh̄tbi DcKwi Zv t GB Mtel Yvq Avcbvi / Avcbvi w̄k̄i i AskMh̄tbi d̄tj msM̄n̄Z Z_ DcvĒ
Kvj vR̄j̄ w̄Yb̄ēq j̄ v̄et̄i Uix cixŋ̄vi w̄w̄f̄b̄w̄ K f̄v̄tj v̄f̄v̄te Rvbevi m̄th̄vM m̄yō Kite |

Z̄t̄_i t̄M̄vc̄b̄qZv t Mtel Yvi Ges Mtel Yvq AskMh̄bKvixi mKj Z_ v̄ej x c̄āvb Mtel t̄Ki w̄bq̄š̄t̄b Zvj v̄e x
Ae_v̄q msi ŋ̄b Kiv n̄t̄e | Gme Z_ GB Mtel Yvi Mtel K Ges Zui ZZ̄ȳeavbKvix ē_w̄ZZ Ab̄ t̄KD t̄ L̄t̄Z
cvi t̄eb bv | Mtel Yvi dj c̄K̄v̄t̄ki mgq t̄Kv_vl Avcbvi / Avcbvi w̄k̄i i bvg w̄Ksev cwi Pq D̄tj L_v̄K̄te bv |

ŋ̄w̄Zc̄ib t Mtel Yvq AskMh̄tbi Rb̄ Avcbv̄t̄K t̄Kvb LiP enb Ki t̄Z n̄t̄e bv w̄Ksev Avcbv̄t̄KI t̄Kvb
A_Ŕ̄w̄o t̄ l̄qv n̄t̄e bv | i t̄³ t̄ivM-R̄xevb̄ym̄s̄μ̄ḡt̄bi ŋ̄j̄Y m̄ə̄eb̄vi Kvi t̄Y h̄w̄ t̄Kvb D̄m̄Z̄ cwi w̄_w̄Z m̄yō nq
Zvnt̄j Avgv̄t̄ i Li t̄P Dc̄t̄iv³ m̄gm̄vi evs̄j̄ v̄t̄ t̄k m̄ə̄e Ggb w̄P̄w̄Krmv Kiv̄t̄bvi w̄w̄qZ̄j Avgiv enb Ki t̄ev |
GQrov Avi t̄Kvb ai t̄bi ŋ̄w̄Zc̄ib ev m̄ȳeav w̄ t̄Z Avgiv Acvi MZv Rvbw̄Q |

Mtel Yv t̄_K c̄Ē_v̄nv̄t̄i i AwaKvi t̄ īaygv̄Ā Avcb̄B GB Mtel Yvq Avcbvi / Avcbvi w̄k̄i i AskMh̄tbi c̄t̄ŋ̄
w̄m̄x̄iŔ̄ t̄bevi AwaKvix | AskMh̄tbi m̄ə̄š̄yZ t̄ evi c̄t̄il Mtel Yvi th t̄Kvb ch̄ēq t̄Kvb i K̄t̄gi ŋ̄w̄Zc̄iY
QrovB Avcb̄ Avcbvi m̄ə̄š̄yZ c̄Ē_v̄nv̄i Ki t̄Z c̄t̄ib | Mtel Yvq AskMh̄Y bv Ki t̄j Ggb̄w̄K AskMh̄tbi ci
m̄ə̄š̄yZ c̄Ē_v̄nv̄i Ki t̄j I Avcb̄ ev Avcbvi w̄k̄i i v̄R̄k̄v̄nx t̄ḡw̄t̄Kj K̄t̄j R̄ n̄v̄m̄cv̄Zv̄t̄j i c̄ēw̄j Z̄ t̄m̄ev w̄K
Av̄t̄Mi ḡZB t̄c̄t̄Z_v̄K̄teb |

Avcbvi AwaKvi I w̄R̄Āmv̄ t GB Mtel Yvi ē_v̄cv̄t̄i Avcbvi t̄Kvb c̄k̄e_v̄K̄t̄j Avgiv Zvi h_vh_ DĒi t̄ t̄ev |
cieZ̄Ŕ̄ZI Avcb̄ Avgv̄t̄ i t̄K c̄k̄eKi t̄Z cvi t̄eb Ges GB Mtel Yvi c̄āvb Mtel K Wrt t̄gvt Av̄ā̄m̄ m̄j̄ v̄t̄gi
m̄v̄t̄_ i v̄R̄k̄v̄nx t̄ḡw̄t̄Kj K̄t̄j t̄Ri gv̄B̄t̄v̄ev̄t̄q̄j Rx w̄ef̄v̄t̄M w̄M̄t̄q A_ev 810983 (Awdm); 01916089071
(t̄ḡv̄ev̄t̄) t̄Uw̄ t̄d̄v̄t̄b th̄v̄M̄th̄v̄M̄ K̄t̄i DĒi t̄c̄t̄Z cvi t̄ib |

m̄ə̄š̄yZ I t̄N̄v̄I Yv t Avcb̄ GB Mtel Yvq Avcbvi / Avcbvi w̄k̄i i AskMh̄t̄b Avgv̄t̄ i c̄ō ū̄v̄te i v̄Rx_v̄K̄t̄j
w̄b̄t̄Pi w̄b̄w̄īō v̄t̄b v̄ŋ̄i A_ev w̄UcmB w̄ b | Avcbvi v̄ŋ̄i GB A_ēnb K̄t̄i th Avcb̄ GB Mtel Yvi
D̄t̄i k̄, c̄x̄w̄Z, S̄K I j̄ v̄f, AskMh̄t̄bi weKí Ges Mtel Yvq AskMh̄YKvix w̄m̄v̄te Avcbvi / Avcbvi w̄k̄i i
Ki Yvq I AwaKvi m̄ə̄t̄Ū w̄e v̄I w̄i Z̄ t̄R̄t̄b m̄ə̄ū̄b̄ŋ̄v̄te ēt̄S Avcbvi m̄ə̄š̄yZ c̄ō vb Ki t̄Qb |

Avcbvi m̄n̄th̄w̄MZvi Rb̄ ab̄ ev̄ |

AskMh̄YKvix / Aw̄f̄f̄v̄t̄K̄i v̄ŋ̄i A_ev ev̄g ēx̄v̄s̄_t̄j i w̄UcmB Zvii Lt

Mtel K / c̄ōZ̄v̄b̄w̄ai v̄ŋ̄i Zvii Lt

v̄ŋ̄i v̄ŋ̄i Zvii Lt

Appendix - 16



გვბტმვეტყვ Rx wefM
ivRkvnx tgvMტKj Kტj R

მასZ cI

bbGbტWvgK-KტUტj

MტelYvi wტიvbvg t Kvj vRჟ mbv³ KiტYi Rb" j"ვეტიUix ciხჟlv mgჟნი weტიLY Ges tj Bkg"wbqv
tWტbvfwbi tRტbvUvBc I tRტbvUvK WvBfvi vmiU vbYჟKib|
cბvb MტelტKi bvg t Wt tgv Avājn mvj vg, mnthMx Aa"vcK, გვბტმვეტყვ Rx wefM, ivRkvnx tgvMტKj
Kტj R |

MტelYv cბZბt გვბტმვეტყვ Rx wefM, ivRkvnx tgvMტKj Kტj R I c"vi vmbტUv Rx j"ვეტიUix,
AvB.vv.vv.vv.Avi ,we, გvLvj x, XvKv|

ფvgKv t ciRwe ewnZ ,iaZcYჟtiM mgჟნი gტa" Kvj vRჟ Ab"Zg| AvμvšI ოტეტj გwQi Kvgტoi
გvāტg G tiM Qovq| mgvტR AZ"š-`wi`"RbტMvōxi gტa" B maviYZ G tiM cბKvc AwaK nტი j ო"
Kiv hvq| weტი 6 wJ გvტ`ტი G tiM cბ fღe itqტQ thLტb cბZ eQi cბq cW j ო" გvბ| Kvj vRჟi
AvμvšI nq Ges Zტ`i gტa" cბq 60,000 ტj vK gZ"yeiY Kტი | Kvj vRჟi AvμvšI ტivMტ`i kZKiv 67
fტიMiB emem fviZ, evsj vტ`k I tbcvტj | evsj vტ`ტი 45 wJ tRjvq G tiM mbv³ Kiv tMტQ Ges
ivRkvnx mn evsj vტ`ტი tek KტqKwJ tRjvq eQტი me mgტqB GB tiM cბ fღe vტიK| Avgvტ`i t`ტი
eQტი Kvj vRჟi AvμvšI ტivMxi msL"v Mტo 7000-9000 Rb| mWkfvტe tivMvbYჟ c"vzi AcბZj Zv I
mჟPvKrmvi Afvტe Kvj vRჟi AvμvšI ტivMტ`i AtბტიKB gZzeiY Kტი | mაცბZ fviZ, evsj vტ`k I tbcvტj
mi Kvi x fvტe Kvj vRჟi wbgჟ Kგmჟx MბY Kiv nტqტQ Ges 2015 mტი j gტa" G tiM wbgჟ i j ო" w"i Kiv
nტqტQ|

MტelYvi DტიK" t cბI weZ Mტelbvq Kvj vRჟ mbv³ KiტYi Rb" cბჟj Z wefბეj "ვეტიUix ciხჟlv e"envi
Kტი tiM vbYჟq G mKj ciხჟlv mgჟნი h_vh_ ფvgKv AbჟvUvb Kiv nტი | cბB DcvE weტიLY Kტი mWkfvტe
G tiM vbYჟqi Rb" GKwJ WvqvMბოK G j ჟmwi`g %Zix Kivi gvāტg Avgvტ`i t`ტი wefბეchჟqi ო"
tmev cბZბტი DcტიMx ciხჟlv cბI vebv Kiv nტი | Kvj vRჟი cბY epEi ivRkvnx GjvKvi Kvj vRჟი
AvμvšI ტivMტ`i t`ტი cბB RxeYyტj Bkg"wbqv tWტbvfwbi tRტbvUvBc I tRტbvUvK WvBfvi vmiU vbYჟ
Kiv nტი |

ტიKb AvcbvტიK / Avcbvi wტიტიK GB MტelYvq AskMბტი Rb" Avneb Kiv nტიQ? t Avcbv/Avcbvi wტი
Kvj vRჟი cბ fღe GjvKiv emem Kტი b bv Ges eZგvტb mჟ" AvტQb RvბტიZ tტი cბI weZ MტelYvi djvდj
mWkfvტe weტიlb Kivi jტი" KტUტj wnmvტe Ask MბY Kivi Rb" Avgiv AvcbvტიK/ Avcbvi wტიტიK
cბI ve KivQ|

MტelYvi c"vz t GB MტelYvq Avcbv/ Avcbvi wტი Avgvტ`i cბI vტe მასZ nტი ;

- 1| Avcbv/ Avcbvi wტი ოფweK wბqტg cბqvRტი GB nvmcvZტი j cბჟj Z wPvKrmv cvტeb |
- 2| MტelYvi cბqvRტი AvcbvტიK/ Avcbvi wტიტიK tiM mაცბU wKQvcბel kvi xvi K ciხჟlv Kiv nტი |
- 3| Mტelbvi weტიK ciხჟlv Rb" Avcbvi/ Avcbvi wტი i nტიZi wკiv t`ტი 3 wგ.wj . i³ cბიტe msMბ Kiv
nტი |
- 4| Avcbvi/ Avcbvi wტი i wბKU nტიZ msMnxZ bgbv i agvI MტelYvi DტიტიK eZგvტb Ges cieZჟZ
ivRkvnx tgvMტKj KტიტიRi გვბტმვეტყვ Rx wefM Ges AvB.vv.vv.vv.Avi we-Gi c"vi vmbტUv Rx
j"ვეტიUix Z e"euZ nტი | Avgiv AvcbvტიK wბბqZv w"vQ th, msMnxZ i³ I cბიტe GB MტelYv Qovv Ab"
ტიKv DტიტიK" e"envi Kiv nტი bv |

Mtel Yvq AskMh̄tbi weKí t AskMh̄Y bv KivB Mtel Yvq AskMh̄tbi weKí |

Mtel Yvq AskMh̄tbi S̄K t w̄kiv n̄Z i³ msM̄ni t̄ŋj̄t̄ mvgv̄ e³ v̄ I Bb̄tdKk̄tbi ŋj̄Y m̄ŋebv̄ _v̄tK |
m̄ŋe³ S̄K Gov̄Z Avgiv R̄xevbyḡ³ mP I w̄M̄t̄c̄w̄mej w̄wi Ā e³ env̄t̄i i w̄b̄ŋQZv̄ c̄ŋ vb̄ Ki w̄Q |

Mtel Yvq AskMh̄tbi DcKwi Zv t GB Mtel Yvq Avcbvi / Avcbvi w̄k̄i i AskMh̄tbi d̄tj̄ msM̄n̄Z Z³ DcvĒ
Kvj̄ v̄R̄j̄ w̄Yb̄ŋj̄ j̄ v̄et̄i Uix̄ cix̄ŋj̄i w̄w̄f̄b̄w̄ K f̄v̄t̄j̄ v̄f̄v̄te Rv̄bevi m̄ŋh̄M̄ m̄j̄ō Kite |

Z̄t̄³ i t̄M̄vc̄b̄qZv̄ t Mtel Yvi Ges Mtel Yvq AskMh̄b̄Kvixi mKj̄ Z³ v̄ej̄ x̄ c̄ŋvb̄ Mtel t̄Ki w̄bq̄ŋ̄t̄b̄ Zvj̄ v̄e x̄
Ae³ v̄q̄ msi ŋj̄b̄ Kiv n̄te | Gme Z³ GB Mtel Yvi Mtel K Ges Zvi ZZ̄yeav̄b̄Kvix̄ e³ w̄ZZ̄ Ab̄ t̄KD t̄ L̄t̄Z̄
cvi t̄eb̄ bv̄ | Mtel Yvi dj̄ c̄K̄v̄t̄ki mgq̄ t̄Kv̄_vl̄ Avcbvi / Avcbvi w̄k̄i i b̄vḡ w̄Ksev̄ c̄wi Pq̄ D̄t̄j̄ L̄_v̄K̄tē bv̄ |

ŋj̄w̄Zc̄ib̄ t̄ Mtel Yvq AskMh̄tbi Rb̄ Avcbv̄t̄K̄ t̄Kvb̄ LiP̄ enb̄ Ki t̄Z̄ n̄tē bv̄ w̄Ksev̄ Avcbv̄t̄K̄I t̄Kvb̄
A³ R̄w̄ō t̄ l̄qv̄ n̄tē bv̄ | i t̄³ t̄iv̄M̄-R̄xev̄b̄ȳm̄ŋḡt̄bi ŋj̄Y m̄ŋeb̄vi Kvi t̄Ȳ h̄w̄ t̄Kvb̄ D³ c̄wi w̄ w̄Z̄ m̄j̄ō nq̄
Zv̄n̄t̄j̄ Avgv̄t̄ i Li t̄P̄ Dc̄t̄iv̄³ m̄gm̄vi ev̄sj̄ v̄ t̄k̄ m̄ŋē Ggb̄ w̄P̄w̄K̄rm̄v̄ Kiv̄t̄b̄vi w̄w̄q̄Z̄j̄ Avgiv̄ enb̄ Ki t̄ev̄ |
GQ̄rov̄ Avi t̄Kvb̄ ai t̄bi ŋj̄w̄Zc̄ib̄ ev̄ m̄jeav̄ w̄ t̄Z̄ Avgiv̄ Ac̄vi M̄Z̄v̄ R̄vb̄w̄Q̄ |

Mtel Yv t̄_K̄ c̄ŋ³ v̄n̄v̄t̄i i AwaKvi t̄ īaygv̄Ā Avcb̄B̄ GB Mtel Yvq Avcbvi / Avcbvi w̄k̄i i AskMh̄tbi c̄t̄ŋj̄
w̄m̄x̄v̄ŋ̄ t̄bevi AwaKvix̄ | AskMh̄tbi m̄ŋŋZ̄ t̄³ ev̄i c̄t̄il̄ Mtel Yvi th̄ t̄Kvb̄ ch̄ŋq̄ t̄Kvb̄ i K̄t̄gi ŋj̄w̄Zc̄iȲ
Q̄rov̄B̄ Avcb̄ Avcbvi m̄ŋŋZ̄ c̄ŋ³ v̄n̄vi Ki t̄Z̄ c̄t̄ib̄ | Mtel Yvq AskMh̄Ȳ bv̄ Ki t̄j̄ Ggb̄w̄K̄ AskMh̄tbi ci
m̄ŋŋZ̄ c̄ŋ³ v̄n̄vi Ki t̄j̄ | Avcb̄ ev̄ Avcbvi w̄k̄i i v̄R̄k̄v̄nx̄ t̄ḡw̄M̄t̄Kj̄ K̄t̄j̄ R̄ n̄v̄m̄cv̄Z̄v̄t̄j̄ i c̄ŋw̄j̄ Z̄ t̄mev̄ w̄K̄
Av̄t̄Mī ḡZB̄ t̄c̄t̄Z̄_v̄K̄tēb̄ |

Avcbvi AwaKvi I w̄R̄Āv̄m̄v̄ t̄ GB Mtel Yvi e³ v̄c̄v̄t̄i Avcbvi t̄Kvb̄ c̄k̄ǣ_v̄K̄t̄j̄ Avgiv̄ Zvi h̄_vh̄_ DĒi t̄ t̄ev̄ |
cieZ̄x̄ŋ̄Z̄I Avcb̄ Avgv̄t̄ i t̄K̄ c̄k̄ǣKi t̄Z̄ cvi t̄eb̄ Ges GB Mtel Yvi c̄ŋvb̄ Mtel K̄ W̄rt̄ t̄ḡv̄t̄ Av̄ā̄m̄ m̄j̄ v̄t̄gi
m̄v̄t̄³ i v̄R̄k̄v̄nx̄ t̄ḡw̄M̄t̄Kj̄ K̄t̄j̄ t̄Rī ḡv̄B̄t̄³ v̄ev̄t̄q̄j̄ R̄x̄ w̄ef̄v̄t̄M̄ w̄M̄t̄q̄ A³ ev̄ 810983 (Awdm); 01916089071
(t̄ḡv̄ev̄t̄) t̄Uw̄j̄ t̄c̄v̄t̄b̄ th̄w̄M̄t̄h̄M̄ K̄t̄i DĒi t̄c̄t̄Z̄ c̄v̄t̄ib̄ |

m̄ŋŋZ̄ I t̄N̄v̄l̄Yv̄ t̄ Avcb̄ GB Mtel Yvq Avcbvi / Avcbvi w̄k̄i i AskMh̄t̄b̄ Avgv̄t̄ i c̄ŋ³ v̄t̄ē i v̄Rx̄_v̄K̄t̄j̄
w̄b̄t̄Pī w̄b̄w̄ī ŋ̄ v̄t̄b̄ v̄ŋj̄i A³ ev̄ w̄Uc̄m̄B̄ w̄ b̄ | Avcbvi v̄ŋj̄i GB A³ enb̄ K̄t̄i th̄ Avcb̄ GB Mtel Yvi
D̄t̄i k̄, c̄x̄w̄Z̄, S̄K̄ I j̄ v̄f̄, AskMh̄t̄bi weKí Ges Mtel Yvq AskMh̄ȲKvix̄ w̄m̄v̄tē Avcbvi / Avcbvi w̄k̄i i
Ki Ȳx̄q̄ I AwaKvi m̄ŋŋŪ̄ we³ v̄ŋj̄i Z̄ t̄R̄t̄b̄ m̄ŋŋŪ̄ v̄tē ēŋS̄ Avcbvi m̄ŋŋZ̄ c̄ŋ vb̄ Ki t̄Qb̄ |

Avcbvi m̄n̄t̄h̄w̄M̄Z̄vi Rb̄ ab̄ ev̄ |

AskMh̄ȲKvix̄ / Aw̄f̄f̄v̄ēt̄Ki v̄ŋj̄i A³ ev̄ ev̄ḡ ēx̄v̄s̄_t̄j̄ i w̄Uc̄m̄B̄ Zvi Lt

Mtel K / c̄ŋZ̄w̄b̄w̄ai v̄ŋj̄i Zvi Lt

v̄ŋj̄i v̄ŋj̄i Zvi Lt