

University of Rajshahi

Rajshahi-6205

Bangladesh.

RUCL Institutional Repository

<http://rulrepository.ru.ac.bd>

---

Department of Mathematics

MPhil Thesis

---

2013

# Stability Analysis of Some Mathematical Models of Epidemics

Islam, Md. Saiful

University of Rajshahi

---

<http://rulrepository.ru.ac.bd/handle/123456789/614>

*Copyright to the University of Rajshahi. All rights reserved. Downloaded from RUCL Institutional Repository.*



# **Stability Analysis of Some Mathematical Models of Epidemics**

**Thesis submitted for the degree of**

**Master of Philosophy**

**In**

**Mathematics**

**By**

**Md. Saiful Islam**

**Under the supervision of**

**Dr. Md. Asaduzzaman**

**Professor**

**Department of Mathematics**

**And**

**Dr. Md. Nazrul Islam Mondal**

**Associate Professor**

**Department of Population Science and Human Resource**

**Development**

**University of Rajshahi, Bangladesh.**

**Department of Mathematics**

**University of Rajshahi, Bangladesh**

**October, 2013**

## DECLARATION

I do hereby declare that the whole work submitted as a thesis entitled **“Stability Analysis of Some Mathematical Models of Epidemics”** to the Department of Mathematics, University of Rajshahi, Bangladesh for the Degree of Master of Philosophy (M.Phil.) in Mathematics is an original research work of mine and have not been previously submitted elsewhere for the award of any other degree.

October, 2013

**Md. Saiful Islam**  
M. Phil. Fellow  
Roll No.: 11316  
Session: 2011-2012  
Department of Mathematics  
University of Rajshahi  
Rajshahi-6205, Bangladesh

## CERTIFICATE

This is to certify that the thesis entitled “**Stability Analysis of Some Mathematical Models of Epidemics**” has been prepared by Md. Saiful Islam under our supervision for submission to the Department of Mathematics, University of Rajshahi, Bangladesh for the Degree of Master of Philosophy (M.Phil.) in Mathematics. It is also certified that the materials included in this thesis are original works of the researcher and have not been previously submitted for the award of any other degree.

### **Supervisor**

**Dr. Md. Asaduzzaman**

Professor

Department of Mathematics

University of Rajshahi

Rajshahi-6205, Bangladesh

### **Co- Supervisor**

**Dr. Md. Nazrul Islam Mondal**

Associate Professor

Department of Population Science and Human Resource Development

University of Rajshahi

Rajshahi-6205, Bangladesh

## ACKNOWLEDGEMENT

All praise of Almighty Allah who has created us and given me a greatest status among all creations. Thanks Allah to give me strength, patience and ability to complete this study.

I would like to express my deep gratitude to my reverend supervisor Dr. Md. Asaduzzaman, Professor, Department of Mathematics, University of Rajshahi, Bangladesh and co-supervisor Dr. Md. Nazrul Islam Mondal, Associate Professor, Department of Population Science and Human Resource Development, University of Rajshahi, Bangladesh for their scholastic and illuminating guidance at all stages of my study in this field of research. Thanks are also due to Professor Dr. M. Abdul Latif, Chairman, Department of Mathematics, University of Rajshahi, Bangladesh for his kind cooperation.

I am very much grateful to Dr. Quazi Selina Sultana, Dr. Mohd. Altab Hossain, Dr. M. Sahadat Hossain and all others faculties of the Department of Mathematics, University of Rajshahi, Bangladesh for their inspiration and cooperation.

I am extremely grateful to Professor Dr. M. Shamsul Alam sharker, Dr. M. Abul Kalam Azad and Dr. M. Ali Akbar, of the Department of Applied Mathematics, University of Rajshahi, Bangladesh for their motivation, valuable suggestions and cooperation.

I am grateful to the faculties of the Department of Computer Science and engineering and concerned authorities of Jatiya Kabi Kazi Nazrul Islam University for allowing me study leave.

On this occasion of a major work in my life, I like to pay due respect the memory of my beloved father and mother to whom I am indebted for every thing of my life. I pray for their salvation.

I also remember the patience of my wife Mrs. Masuma Islam during my working hour for the thesis. Thanks are also due to my daughter Sabrina Islam for her nice and understanding behavior during my research work.

Finally I like to share my satisfaction of completing this task with my well wishers, friends and relatives but the responsibility of errors and deficiencies that still remain devolves on me along.

**Md. Saiful Islam**

## ABSTRACT

The spread of communicable diseases is often described mathematically by compartmental models. Many epidemiological models have a Disease Free Equilibrium (DFE) at which the population remains in the absence of disease. The classical Susceptible Infected Removed (SIR) models are very essential as conceptual models like as predator-prey and competing species models in ecology. Some Susceptible Infected (SI) and Susceptible Infected Susceptible (SIS) type models have been considered in this study. There are two major types of control strategies available to limit the spread of infectious diseases, viz. pharmaceutical interventions (drugs, vaccines, etc.), and non-pharmaceutical interventions (social distancing, quarantine, etc.). Vaccination is important for the elimination of infectious diseases as an effective preventive strategy. Vaccination of susceptible individual has been introduced through Susceptible Infected Removed Susceptible (SIRS) models. Effective vaccines have been used successfully to control smallpox, polio and measles.

Some models have been presented in this study for the transmission dynamics of infectious diseases to analyze the stability of various equilibrium points mathematically. Some Susceptible Vaccinated Infected Susceptible (SVIS) and Susceptible Vaccinated Infected (SVI) models have been introduced in this study by including a new compartment 'V' for vaccinated individual in SIS and SI type models respectively. The above models have various kinds of parameters. Mainly the stability is analyzed by bifurcation curves in the SVIS models. The basic reproductive number ( $R_0$ ) can be calculated due to DFE in the SVI model. Some controlling methods have been given by changing the parameters in the SVI model through  $R_0$ .

# CONTENTS

<b>Declaration</b>	<b>i</b>
<b>Certificate</b>	<b>ii</b>
<b>Acknowledgements</b>	<b>iii</b>
<b>Abstract</b>	<b>v</b>
<b>Contents</b>	<b>vi</b>
<b>List of table</b>	<b>ix</b>
<b>List of figure</b>	<b>x</b>
<b>List of abbreviation</b>	<b>xii</b>
<b>Chapter One: Introduction to Mathematical Modeling</b>	<b>1-17</b>
1.1    Background of the study	1
1.2    Basic concept of mathematical modeling	1
1.3    Methods of a mathematical modeling	3
1.3.1    Stages of modeling	3
1.3.2    Dimensional homogeneity and consistency	4
1.3.3    Abstraction and scaling	5
1.3.4    Conservation and balance principles	6
1.3.5    Constructing linear models	6
1.4    Types of mathematical model	7
1.4.1    Linear or nonlinear	7
1.4.2    Deterministic or probabilistic (stochastic)	8
1.4.3    Static or dynamic	9
1.4.3    Discrete or Continuous	9
1.4.3    Deductive, inductive, or floating	9
1.5    Characteristics of mathematical models	10
1.5.1    Models are necessarily incomplete	10
1.5.1    The model may be changed or manipulated with relative ease	11



1.6	Areas of modeling	12
1.6.1	A list of applications of modeling	13
1.7	Limitations of mathematical modeling	15
1.8	Conclusion	17
<b>Chapter Two: Qualitative Analysis of Differential Equations</b>		<b>18-36</b>
2.1	Phase space and trajectory	18
2.2	Linear approximation	18
2.3	Linearization of a system and Jacobean	21
2.4	Solution of first order linear system	25
2.5	Catalogue of singularities in the phase plane	30
2.6	Conclusion	36
<b>Chapter Three: Simple Epidemic Models</b>		<b>37-71</b>
3.1	Introduction	37
3.2	Basic concepts	38
3.3	SI model	39
3.3.1	Model formulation	39
3.3.2	Solution of model	41
3.3.3	Interpretation	42
3.4	SIS model	45
3.4.1	Model formulation	46
3.4.2	Solution of model	47
3.4.3	Interpretation	49
3.5	SIR model	57
3.5.1	Model formulation	57
3.5.2	Solution of model	60
3.5.3	Interpretation	61
3.5.4	Asymptotic behavior of the solution	62
3.5.5	Approximate solution	67
3.6	Conclusion	71

<b>Chapter Four: SVIS Model</b>	<b>72-96</b>
4.1 Introduction	72
4.2 A model of SVIS type without disease-related death	75
4.2.1 Equilibriums and stability analysis	80
4.3 A model of SVIS type with disease-related death.	84
4.3.1 Equilibriums and stability analysis	87
4.3.2 The case where there are no infective immigrants	89
4.4 Conclusion	95
<b>Chapter Five: SVI Model</b>	<b>97-115</b>
5.1 Introduction	97
5.2 Model formulation	99
5.3 Equilibrium conditions	101
5.4 Stability at DFE	102
5.4.1 Controlling the epidemic	103
5.4.2 Numerical simulation	105
5.4.3 Discussion	110
5.5 Stability analysis of endemic equilibrium	110
5.6 Conclusion	115
<b>Chapter Six: Conclusion</b>	<b>116-117</b>
<b>Bibliography</b>	<b>118-129</b>

## LIST OF TABLE

<b>Table No</b>	<b>Description</b>	<b>Page</b>
4.1.1	Summary of notation for SVIS model	74
5.4.1	Results for step-1	106
5.4.2	Results for step-2	107
5.4.3	Results for step-3	108
5.4.4	Results for step-4	109

## LIST OF FIGURE

Figure No	Description	Page
2.2.1	Linear approximation	20
2.3.1	Linearization of a system	24
2.5.1	Node (Type I) singularity	31
2.5.2	Saddle point singularity	32
2.5.3	Spiral singularity	33
2.5.4	Centre singularity	33
2.5.5	Node (Type II) singularity	34
2.5.6	Star singularity	34
2.5.7	Summarizes of the results	35
3.3.1	Solution of SI model	42
3.3.2	Epidemic curve of SI model	44
3.4.1	Diagram of SIS model	46
3.4.2	Solution of SIS model	50
3.5.1	Diagram of SIR model	57
3.5.2	Graph of $I(t)$	63
3.5.3	Graph of $S(t)$	63
3.5.4	Graph of $R(t)$	64
3.5.5	Graph of equation (3.5.9)	66
4.1.1	Diagram of SVIS model	74
4.2.1	Bifurcation curve $\phi$ vs $I$	84
4.3.1	Bifurcation curve $\phi$ vs $I$ with disease-related death	89
4.3.2	Bifurcation curve $\phi$ vs $I$ with no infective immigrants	95

5.2.1	Diagram of SVI model	100
5.4.1	Graph of $I(t)$ for step-1	106
5.4.2	Graph of $I(t)$ for step-2	107
5.4.3	Graph of $I(t)$ for step-3	108
5.4.4	Graph of $I(t)$ for step-4	109

## **LIST OF ABBREVIATION**

- AIDS : Acquired Immune Deficiency Syndrome
- DFE : Disease Free Equilibrium
- HIV : Human Immunodeficiency Virus
- SEIR : Susceptible Exposed Infected Removed
- SEIS : Susceptible Exposed Infected Susceptible
- SI : Susceptible Infected
- SIR : Susceptible Infected Removed
- SIRS : Susceptible Infected Removed Susceptible
- SIS : Susceptible Infected Susceptible
- SVI : Susceptible Vaccinated Infected
- SVIS : Susceptible Vaccinated Infected Susceptible

# **CHAPTER ONE**

## **INTRODUCTION TO MATHEMATICAL MODELING**

### **1.1 Background of the study**

Epidemiology is a study of infectious diseases, the causes of their occurrence and their spread in space and time. Mathematical epidemiology is understanding biological phenomena, translating assumptions, regarding biological features to mathematical language, finding solutions of mathematical problems and last, but certainly not least, translating the results back to biology. Communicable diseases may be introduced into a population through the migration of infective individuals from outside into the host population. Various kinds of deterministic models for the spread of infectious disease have been analyzed mathematically and applied to control the epidemic. In this thesis we demonstrate how a mathematical model can describe epidemiological phenomena and how we can use such a model to analyze endemic states and help eradicate diseases. A model was set up using a system of nonlinear ordinary differential equations and this is analyzed mathematically. Computer software gives a concrete picture of numerical predictions and indicates the direction for mathematical analysis and proof.

### **1.2 Basic concept of mathematical modeling**

Mathematical modeling is a technique of translating real world problems into mathematical problems, solving the mathematical problems and interpreting these solutions in the language of real world. It may not be possible to solve the resulting mathematical problems. As such it is necessary to idealize or simplify the problem or

approximate it by another problem which is quite close to the original problem and it can be translated and solved mathematically. In this idealization, we try to retain all the essential features of the problems other than those features which are not very essential or relevant to the situation we are investigating.

Sometimes mathematical model is a description of a system using mathematical concepts and language. The process of developing a mathematical model is termed mathematical modeling. Mathematical models are used not only in the natural sciences (such as physics, biology, earth science, meteorology) and engineering disciplines (e.g. computer science, artificial intelligence), but also in the social sciences (such as economics, psychology, sociology and political science); physicists, engineers, statisticians, operations research analysts and economists use mathematical models most extensively. A model may help to explain a system and to study the effects of different components, and to make predictions about behavior.

Mathematical models can take many forms, including but not limited to dynamical systems, statistical models, differential equations or game theoretic models. These and other types of models can overlap with a given model involving a variety of abstract structures. In general, mathematical models may include logical models, as far as logic is taken as a part of mathematics. In many cases, the quality of a scientific field depends on how well the mathematical models developed on the theoretical side agree with results of repeatable experiments. Lack of agreement between theoretical mathematical models and experimental measurements often leads to important advances as better theories are developed.



### 1.3 Methods of a mathematical modeling

The following methods are helpful for good modeling.

#### 1.3.1 Stages of modeling

It is helpful to divide up the stages of modeling into the following categories of activity:

- i. Gather the following information: what we already know; sources of relevant data; our assumptions; what we would like to predict with the model; ways of verifying that the model will be built correctly; and ways to validate the model.
- ii. Sketch simple diagrams that outline the elements in the model and how they are connected to each other.
- iii. Conduct a throughout literature review. There is no need to re-invent the wheel if somebody else has developed a model that may suit our purposes already. However, we need to fully understand all the assumptions and the applicability of a model before using it.
- iv. Conduct a throughout review of data that we plan to use. Identify the discrepancies and inconsistencies between and within the data sets. Often, there is missing data, so we have to think carefully about how we are going to handle missing data. If possible, quantify the uncertainties associated with the data.
- v. Begin with a simple model. In general, there is a simple trade-off between complexity and accuracy. Among models with similar predictive power, the simplest one is the most desirable.

- vi. Identify important variables and constants and determine how they relate to each other. The most important variables are input and output variables. Within the models, we can have other types of models such as decision variables, random variables or state variables.
- vii. Construct equations that relate variables to each other.
- viii. Identify the parameters of the equations and develop a plan how to estimate the parameters from the data. This could be done simply by fitting the equations to the data. However, more complex models may require sophisticated parameter calibration methods.
- ix. Validate our model against a data set that we have not used to build the model.
- x. Constantly test our model and update our equations based on new data and information.

### **1.3.2 Dimensional homogeneity and consistency**

The dimension of a physical quantity can be expressed as a product of the basic physical dimensions mass, length, time, electric charge, and absolute temperature, represented by symbols M, L, T, Q, and  $\Theta$ , respectively. The term dimension is more abstract than scale unit. Mass is a dimension, while kilograms are a scale unit (choice of standard) in the mass dimension. As examples, the dimension of the physical quantity speed is length/time ( $L/T$  or  $LT^{-1}$ ), and the dimension of the physical quantity force is "mass  $\times$  acceleration" or "mass $\times$ (length/time)/time" ( $ML/T^2$  or  $MLT^{-2}$ ). The basic and powerful idea of mathematical modeling that; every equation used in a mathematical model must be dimensionally consistent. So, it is completely logical every in an energy equation has total dimensions of energy. Similarly, every

term in a balance of mass should have the dimension mass. This statement provides the basis for a technique called dimensional analysis.

We know a rational equation is an equation in which every independent term has same dimension. So, by taking its completion we can say that the equation is dimensionally homogeneous. Thus, we cannot add length to area or time to mass in an equation but we can add easily those quantities which have the same dimension even that are expressed in different units, e.g., length in meters or length in mile. We should remember that a dimensionally homogeneous equation is independent of unit of measurement used in this equation. However, we can create unit-dependent versions of such equations because they may be more convenient for doing repeated calculations.

### **1.3.3 Abstraction and scaling**

An important decision in modeling is choosing an appropriate level of detail for the problem at hand, and thus knowing what level of detail is prescribed for the attendant model. This process is called abstraction and it typically requires a thoughtful approach to identifying those phenomena on which we want to focus, that is, to answering the fundamental question

About why a model is being sought or developed. For example, a linear elastic spring can be used to model more than just the relation between force and relative extension of a simple coiled spring, as in an old-fashioned butcher's scale or an automobile spring. It can also be used to model the static and dynamic behavior of a tall building, perhaps to model wind loading, perhaps as part of analyzing how the building would respond to an earthquake. In these examples, we can use a very abstract model by

subsuming various details within the parameters of that model. In addition, as we talk about finding the right level of abstraction or the right level of detail, we are simultaneously talking about finding the right scale for the model we are developing. For example, the spring can be used at a much smaller, micro scale to model atomic bonds, in contrast with the macro level for buildings. The notion of scaling includes several ideas, including the effects of geometry on scale, the relationship of function to scale, and the role of size in determining limits—all of which are needed to choose the right scale for a model in relation to the “reality” we want to capture.

### **1.3.4 Conservation and balance principles**

When we develop mathematical models, we often start with statements that indicate that some property of an object or system is being conserved. For example, we could analyze the motion of a body moving on an ideal, frictionless path by noting that its energy is conserved. Sometimes, as when we model the population of an animal colony or the volume of a river flow, we must balance quantities of individual animals or water volumes, that cross a defined boundary. We will apply balance or conservation principles to assess the effect of maintaining or conserving levels of important physical properties. Conservation and balance equations are related in fact, conservation laws are special cases of balance laws.

### **1.3.5 Constructing linear models**

Linearity is one of the most important concepts in mathematical modeling. Models of devices or systems are said to be linear when their basic equations whether algebraic, differential, or integral are such that the magnitude of their behavior or response produced is directly proportional to the excitation or input that drives them. Even

when devices like the pendulum are more fully described by nonlinear models, their behavior can often be approximated by linearized or perturbed models, in which cases the mathematics of linear systems can be successfully applied. We apply linearity when we model the behavior of a device or system that is forced or pushed by a complex set of inputs or excitations. We obtain the response of that device or system to the sum of the individual inputs by adding or superposing the separate responses of the system to each individual input. This important result is called the principle of superposition. Engineers use this principle to predict the response of a system to a complicated input by decomposing or breaking down that input into a set of simpler inputs that produce known system responses or behaviors.

In this section we have provided an overview of the foundational material of mathematical modeling and set out a principled approach to doing mathematical modeling. We have also outlined some of the important tools that will be covered in greater detail later: dimensional analysis, abstraction and scaling, balance laws, and linearity.

## **1.4 Types of mathematical models**

Mathematical models can be classified according to their nature as follows:

### **1.4.1 Linear or nonlinear**

Mathematical models are usually composed by variables, which are abstractions of quantities of interest in the described systems, and operators that act on these variables, which can be algebraic operators, functions, differential operators, etc. If all the operators in a mathematical model exhibit linearity, the resulting mathematical model is defined as linear. A model is considered to be nonlinear otherwise. The

question of linearity and nonlinearity is dependent on context, and linear models may have nonlinear expressions in them. For example, in a statistical linear model, it is assumed that a relationship is linear in the parameters, but it may be nonlinear in the predictor variables. Similarly, a differential equation is said to be linear if it can be written with linear differential operators, but it can still have nonlinear expressions in it. In a mathematical programming model, if the objective functions and constraints are represented entirely by linear equations, then the model is regarded as a linear model. If one or more of the objective functions or constraints are represented with a nonlinear equation, then the model is known as a nonlinear model. Nonlinearity, even in fairly simple systems, is often associated with phenomena such as chaos and irreversibility. Although there are exceptions, nonlinear systems and models tend to be more difficult to study than linear ones. A common approach to nonlinear problems is linearization, but this can be problematic if one is trying to study aspects such as irreversibility, which are strongly tied to nonlinearity.

#### **1.4.2 Deterministic or probabilistic (stochastic)**

A deterministic model is one in which every set of variable states is uniquely determined by parameters in the model and by sets of previous states of these variables. Therefore, deterministic models perform the same way for a given set of initial conditions. For example, the model for the motion of a simple pendulum is deterministic. Conversely, in a stochastic model, randomness is present, and variable states are not described by unique values, but rather by probability distributions. For example, if a rubber ball is dropped from a given height and measures the bounce with sufficient accuracy it will be found that if the same process is repeated many times, the height of bounce may not be the same every time.

**1.4.3 Static or dynamic**

If in a mathematical model, the model equations are independent of time then model is said to be static. The fluid flowing through a rigid diverging tube is an example of static model. On the other hand if the time plays a very important role with the variables or relation describing the model changing with time, then the model is said to be dynamic. Most of the real life problem, e.g., the population growth model, bacterial growth model, rocket launching model is examples of dynamic model. Dynamic models typically are represented with difference equations or differential equations.

**1.4.4 Discrete or Continuous**

A model is said to be discrete if the independent variables take the discrete value. In this model the mathematical equations are taken as difference equations. On the other hand, if the model is based on continuous variables, then it is called continuous model. Most of the continuous model formulated by differential equation either ordinary or partial.

**1.4.5 Deductive, inductive, or floating**

A deductive model is a logical structure based on a theory. An inductive model arises from empirical findings and generalization from them. The floating model rests on neither theory nor observation, but is merely the invocation of expected structure. Application of mathematics in social sciences outside of economics has been criticized for unfounded models. Application of catastrophe theory in science has been characterized as a floating model.

It is also may be classified according to the subject matter of the models. There are mathematical modes in physics, chemistry, biology, medicine, economics, psychology, sociology, engineering and so on. Similarly there are mathematical models for transportation, urban and regional planning, water resources, optimal utilization and renewable resources, pollution, environment, oceanography, blood flows, genetics, political systems, land distribution and so on.

We also classified mathematical models according to the mathematical techniques used in solving them as mathematical modeling through classical algebra, linear algebra and matrices, ordinary and partial differential equations, difference equations, integral equations, integro-differential equations, functional equations, graphs, mathematical programming, calculus of variations, maximum principle and so on.

## **1.5 Characteristics of mathematical models**

### **1.5.1 Models are necessarily incomplete**

Model is a representation. There no model which includes every aspect of the real world. If it did, it would no longer be a model. In order to create a model, a scientist must first make some assumptions about the essential structure and relationships of objects and/or events in the real world. These assumptions are about what is necessary or important to explain the phenomena. For example, a behavioral scientist might wish to model the time it takes a rat to run a maze. In creating the model the scientist might include such factors as how hungry the rat was, how often the rat had previously run the maze, and the activity level of the rat during the previous day. The model-builder would also have to decide how these factors interacted when constructing the model. The scientist does not assume that only factors included in the



model affect the behavior. Other factors might be the time-of-day, the experimenter who ran the rat, and the intelligence of the rat. The scientist might assume that these are not part of the "essential structure" of the time it takes a rat to run a maze. All the factors that are not included in the model will contribute to error in the predictions of the model.

### **1.5.2 The model may be changed or manipulated with relative ease**

It must be easier to manipulate the model than the real world. The scientist or technician changes the model and observes the result, rather than doing a similar operation in the real world. He or she does this because it is simpler, more convenient, and/or the results might be catastrophic.

A race car designer, for example, might build a small model of a new design and test the model in a wind tunnel. Depending upon the results, the designer can then modify the model and retest the design. This process is much easier than building a complete car for every new design. The usefulness of this technique, however, depends on whether the essential structure of the wind resistance of the design was captured by the wind tunnel model.

Changing symbolic models is generally much easier than changing physical models. All that is required is rewriting the model using different symbols. Determining the effects of such models is not always so easily accomplished. In fact, much of the discipline of mathematics is concerned with the effects of symbolic manipulation.

If the race car designer was able to capture the essential structure of the wind resistance of the design with a mathematical model or computer program, he or she would not have to build a physical model every time a new design was to be tested.

All that would be required would be the substitution of different numbers or symbols into the mathematical model or computer program. As before, to be useful the model must capture the essential structure of the wind resistance.

The values, which may be changed in a model to create different models are called parameters. In physical models, parameters are physical things. In the race car example, the designer might vary the length, degree of curvature, or weight distribution of the model. In symbolic models parameters are represented by symbols. For example, in mathematical models parameters are most often represented by variables. Changes in the numbers assigned to the variables change the model.

### **1.6 Areas of modeling**

Mathematical modeling is an art of translating real life problems from an application area into tractable mathematical formulations whose theoretical and numerical analysis provides insight, answers, and guidance useful for the originating application.

So, Mathematical modeling

- (i) is indispensable in many applications,
- (ii) is successful in many further applications,
- (iii) gives precision and direction for problem solution,
- (iv) enables a thorough understanding of the system modeled,
- (v) prepares the way for better design or control of a system,
- (vi) allows the efficient use of modern computing capabilities.

Learning about mathematical modeling is an important step from a theoretical mathematical training to an application-oriented mathematical expertise, and makes the student fit for mastering the challenges of our modern technological culture.

### **1.6.1 A list of applications of modeling**

In the following, I give a list of applications which modeling I understand, at least in some detail. All areas mentioned have numerous mathematical challenges.

This list is based on my own experience; therefore it is very incomplete as a list of applications of mathematics in general. There are an almost endless number of other areas with interesting mathematical problems.

Indeed, mathematics is simply the language for posing problems precisely and unambiguously (so that even a stupid, pedantic computer can understand it).

**Anthropology:** Modeling, classifying and reconstructing skulls

**Archeology:** Classifying ancient artifices, Reconstruction of objects from preserved fragments

**Architecture:** Virtual reality

**Artificial intelligence:** Computer vision, Image interpretation, Robotics, Optical character recognition, Reasoning under uncertainty, Speech recognition

**Arts:** Computer animation (Jurassic Park)

**Astronomy:** Correcting the Hubble telescope, Evolution of stars, Detection of planetary systems, Origin of the universe

**Biology:** Animal and plant breeding (genetic variability), Evolutionary pedigrees, Humane genome project, Morphogenesis, Population dynamics, Protein folding, Spreading of infectious diseases (AIDS)

**Chemical engineering:** Chemical equilibrium, Planning of production units

**Chemistry:** Chemical reaction dynamics, Electronic structure calculations, Molecular modeling

**Computer science:** Image processing, Realistic computer graphics (ray tracing)

**Criminalistic science:** Face recognition, Finger print recognition

**Economics:** Labor data analysis

**Electrical engineering:** Microchip analysis, Power supply network optimization, Stability of electric circuits

**Finance:** Risk analysis, Value estimation of options

**Fluid mechanics:** Turbulence, Wind channel

**Geosciences:** Earth quake prediction, Map production, Prediction of oil or ore deposits

**Internet:** Optimal routing, Web search

**Linguistics:** Automatic translation

**Materials Science:** Microchip production, Microstructures, Semiconductor modeling

**Mechanical engineering:** Crash simulation, Stability of structures (high rise buildings, bridges, air planes), Structural optimization

**Medicine:** Blood circulation models, Computer-aided tomography, Radiation therapy planning

**Meteorology:** Climate prediction (global warming, what caused the ozone hole?), Weather prediction

**Music:** Analysis and synthesis of sounds

**Neuroscience:** Neural networks, Signal transmission in nerves

**Pharmacology:** Docking of molecules to proteins, Screening of new compounds

**Physics:** Elementary particle tracking, Laser dynamics, Quantum field theory predictions (baryon spectrum)

**Political Sciences:** Analysis of elections

**Psychology:** Formalizing diaries of therapy sessions

**Space Sciences:** Flight simulation, Trajectory planning, Shuttle reentry

**Transport Science:** Air traffic scheduling, Automatic pilot for cars and airplanes, Taxi for handicapped people

## **1.7 Limitations of mathematical modeling**

Mathematical modeling is a multi-stage process in which there requires a variety of concepts and techniques. There are thousands of mathematical models, which have

been successfully developed but their results are not match with the real world problems. Infect mathematical physics, biomathematics, mathematical economics, operation research etc. are almost synonymous with mathematical modeling. However, there are still a large number of situation, which have not mathematically modeled yet. Because either the situation is sufficiently complex or the models formed are mathematically not correct.

During the formulation of any model we make some assumptions, therefore the model is only as good as the assumptions made while formulating it and any extrapolation which violate the assumption may be dangerous.

For example: If we consider a population model in which model equation is

$$\frac{dN}{dt} = \lambda N,$$

where  $N(t)$  represent the population at time  $t$ .

Then its solution is  $N(t) = N_0 e^{\lambda t}$ , where  $N_0$  is the population at time  $t_0$ . The solution gives  $N(t) \rightarrow \infty$  as  $t \rightarrow \infty$ ; this means the population grows exponentially without any bound. The above result is not found in the nature. Thus, there is a need to modify the model.

The powerful computer has enabled to mathematically model a large number of situations. Moreover it has been possible to make more realistic model and to obtain better agreement with observations.

However there are not available successful guidelines to choose the number of parameters and estimate the values for these parameters. In fact, by choosing a number of parameters an accurate model can be developed to fit any data. Mathematical modeling of large-scale system presents its own special problems. These arise in study of world models and in global models of environment, economic condition, oceanography, pollution control etc.

However mathematical modelers from all disciplines, such as mathematics, statistics, physics, computer science, engineering, social science are meeting the challenges with courage.

## **1.8 Conclusion**

In this chapter we have given a fundamental overview of mathematical modeling. For this purpose, it has been defined mathematical modeling, provided Basic Concept of Mathematical Modeling, its use in science and engineering and set out a principle approach to doing modeling. Also we have outlined some of the important tools such as Types of modeling, its application and limitation of mathematical modeling.

# CHAPTER TWO

## QUALITATIVE ANALYSIS OF DIFFERENTIAL EQUATIONS

### 2.1 Phase space and trajectory

A multidimensional space in which each axis corresponds to one of the coordinates required to specify the state of a physical system, all the coordinates being thus represented so that a point in the space corresponds to a state of the system. It yields the following definition:

**Definition 2.1.1** An ideal space in which the coordinate dimensions represent the variables that are required to describe a dynamical system is called the phase space or phase portrait of the dynamical system.

In particular, if the dynamical system is two-dimensional then the phase space is called phase plane.

In autonomous systems there is a way of visualizing the solutions that can be very powerful. Instead of plotting values of  $x$  and  $y$  as functions of time, we view these values as coordinates of a point in the  $x$ - $y$  plane. As the system changes, the point  $(x, y)$  will trace out a curve in this plane. The point  $(x, y)$  is called a state. The solution curves that get traced out in phase space are called trajectory.

### 2.2 Linear approximation

The next question is the linear approximation of a function of two variables. For a function of one variable linear approximation is based on the definition of the derivative



$$f'(x) = \lim_{h \rightarrow 0} \frac{f(x+h) - f(x)}{h}$$

If we write this formula without the limit, we get an approximate equality, instead of the exact equality:

$$f'(x) \approx \frac{f(x+h) - f(x)}{h}$$

or,

$$f(x+h) - f(x) \approx hf'(x) \tag{2.2.1}$$

and finally we can find that:

$$f(x+h) \approx f(x) + hf'(x) \tag{2.2.2}$$

This formula tells us that if we know the value of function and its derivative at any point  $x$ , we can approximately find it at a (close) point which is at distance  $h$  from  $x$ . This formula will be more accurate if  $h$  will be closer to 0. We will use this formula for approximation of function of two variables. For that, let us reformulate it first in a more general way. We can say about formula (2.2.2) as that:

**Conclusion:** Difference of a function  $f$  at points  $x$  and  $x+h$  is approximately equal to the rate of change of function at the point  $x$  times the distance between these points.

Let us derive a similar formula for a function of two variables  $f(x, y)$ .

Let us assume, that we know  $f(x, y)$  and its partial derivatives at some point  $(x, y)$  and we want to find the value of the function at the point  $(x+h, y+k)$  which is closed to  $(x, y)$  (see figure 2.2.1).

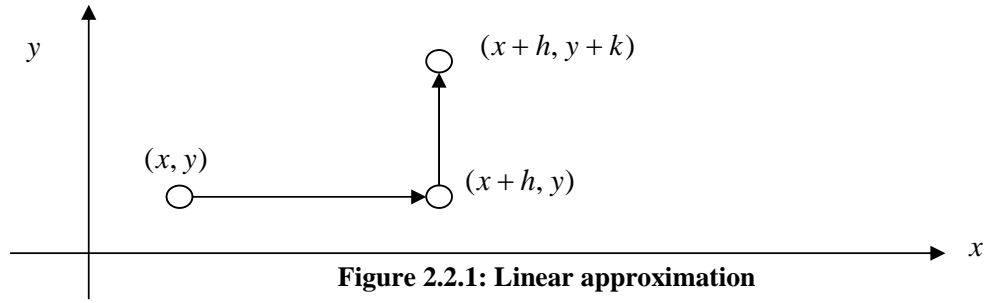

Let us move to the point  $(x+h, y+k)$  in two steps. Let us first move from the point  $(x, y)$  to the point  $(x+h, y)$  i.e. in the  $x$ -direction, and then from  $(x+h, y)$  to the point  $(x+h, y+k)$ , i.e. in the  $y$ -direction. Let us apply the formula for approximation of function of one variable in formulation of above conclusion at each part of this motion. Because at the first part we move along the  $x$  direction the change of the function  $\Delta f_1$  will be given as a product of the rate of change of function in the  $x$  direction  $\frac{\partial f}{\partial x}$  times the distance between the points  $(x, y)$  and  $(x+h, y)$ :

$$\Delta f_1 = f(x+h, y) - f(x, y) = \frac{\partial f}{\partial x} h \quad (2.2.3)$$

Similarly, on the second part of our motion, we move along the  $y$  axis, and the change of the function here ( $\Delta f_2$ ) will be given as a product of the rate of change of function in the  $y$  direction  $\frac{\partial f}{\partial y}$  times the distance between the points  $(x+h, y)$  and  $(x+h, y+k)$ :

$$\Delta f_2 = f(x+h, y+k) - f(x+h, y) = \frac{\partial f}{\partial y} k \quad (2.2.4)$$

Now from (2.2.3) and (2.2.4) we get

$$f(x+h, y+k) = f(x, y) + \frac{\partial f(x, y)}{\partial x} h + \frac{\partial f(x, y)}{\partial y} k \quad (2.2.5)$$

This expression is called a linear approximation, as the independent variables  $h, k$  are in the first power only.

**Example 2.2.1:** Find the linear approximation for the function  $e^{x+2y}$  at the point  $x=0, y=0$ .

**Solution:** We use the formula (2.2.5)

Here  $f(x, y) = e^{x+2y}$  and  $x=0, y=0$ .

Now 
$$\frac{\partial f}{\partial x} = e^{x+2y} \text{ and } \frac{\partial f}{\partial y} = 2e^{x+2y}$$

So at the point  $x=0, y=0$ ;

$$f(x, y) = 1, \frac{\partial f}{\partial x} = 1 \text{ and } \frac{\partial f}{\partial y} = 2.$$

Finally  $f(h, k) = e^{h+2k} = 1 + 1h + 2k$

At  $h=0.1, k=0.1$  the approximate formula gives:  $e^{h+2k} = 1 + 0.1 + 2 \times 0.1 = 1.3$ . The exact value of  $e^{h+2k} = e^{0.3} = 1.3498$

### 2.3 Linearization of a system and jacobian

Consider a general system of two autonomous differential equations:

$$\begin{cases} \frac{dx}{dt} = f(x, y) \\ \frac{dy}{dt} = g(x, y) \end{cases} \quad (2.3.1)$$

**Definition 2.3.1:** A point  $(x^*, y^*)$  is called an equilibrium point of the system (2.3.1)

if  $f(x^*, y^*) = g(x^*, y^*) = 0$ . i.e., if the system is placed to the equilibrium it will stay

there forever. Thus this trajectory will contain just one point.

**Definition 2.3.2:** An equilibrium point of a linear autonomous dynamical system is stable, if there is a neighborhood of this equilibrium, such that all trajectories which start at this neighborhood will converge to the equilibrium and the equilibrium point is called unstable, if there is at least one diverging trajectory from each close neighborhood of this equilibrium.

We want to study it close to its equilibrium points. For that let us approximate the functions of two variables  $f(x, y)$  and  $g(x, y)$ , using the linear approximation (2.2.5) and later solve the approximated system and find the phase portrait close to equilibrium.

Assume that system (2.3.1) has an equilibrium point at  $(x^*, y^*)$ . This means that:

$$\begin{cases} f(x^*, y^*) = 0 \\ g(x^*, y^*) = 0 \end{cases} \quad (2.3.2)$$

Let us approximate  $f(x, y)$  close to the equilibrium  $(x^*, y^*)$  using the formula (2.2.5):

$$f(x^* + h, y^* + k) = f(x^*, y^*) + \frac{\partial f(x^*, y^*)}{\partial x} h + \frac{\partial f(x^*, y^*)}{\partial y} k$$

As we assumed  $(x^*, y^*)$  is an equilibrium, i.e.  $f(x^*, y^*) = 0$  and we get

$$f(x^* + h, y^* + k) = \frac{\partial f(x^*, y^*)}{\partial x} h + \frac{\partial f(x^*, y^*)}{\partial y} k \quad (2.3.3)$$

A similar approach for  $g(x^* + h, y^* + k)$  yields:

$$g(x^* + h, y^* + k) = \frac{\partial g(x^*, y^*)}{\partial x} h + \frac{\partial g(x^*, y^*)}{\partial y} k \quad (2.3.4)$$

Thus using these approximate formulas we can find the right hand side functions of (2.3.1) at any point which is located at point  $(h, k)$  relative to the equilibrium point  $(x^*, y^*)$ . Now let us substitute these approximations to system (2.3.1). For that

we need to replace the right hand sides of (2.3.1) by their approximations (2.3.3),

(2.3.4), but it would be also good to rewrite the derivatives  $\frac{dx}{dt}$  and  $\frac{dy}{dt}$  in the same

relative coordinates  $h, k$ . We see that  $x = x^* + h$  and its derivative with respect to

time  $t$  is  $\frac{dx}{dt} = \frac{d(x^*)}{dt} + \frac{dh}{dt} = \frac{dh}{dt}$  as  $x^*$  is a constant. Similarly,  $\frac{dy}{dt} = \frac{d(y^*)}{dt} + \frac{dk}{dt} = \frac{dk}{dt}$ .

After substitution of (2.3.3), (2.3.4) and the expressions for  $\frac{dx}{dt}$  and  $\frac{dy}{dt}$  into (2.3.1)

we get:

$$\begin{cases} \frac{dh}{dt} = \frac{\partial f(x^*, y^*)}{\partial x} h + \frac{\partial g(x^*, y^*)}{\partial y} k \\ \frac{dk}{dt} = \frac{\partial g(x^*, y^*)}{\partial x} h + \frac{\partial g(x^*, y^*)}{\partial y} k \end{cases} \quad (2.3.5)$$

System (2.3.5) is simpler than the original system (2.3.1), as the partial derivatives in

(2.3.5) are constants (numbers). If we denote the local coordinates relative to the

equilibrium point as:

$$u = h = x - x^* \quad \text{and} \quad v = k = y - y^* \quad (2.3.6)$$

We can rewrite (2.3.5) as:

$$\begin{cases} \frac{du}{dt} = au + bv \\ \frac{dv}{dt} = cu + dv \end{cases} \quad (2.3.7)$$

System (2.3.7) is a linearization of the system (2.3.1). It is expressed in terms of

functions  $u$  and  $v$ , which are relative values of our variables with respect to the

equilibrium point  $(x^*, y^*)$ . If we find these unknown functions  $u$  and  $v$  we can easily

find the original functions  $x, y$  using (2.3.6) as  $x = u + x^*$  and  $y = v + y^*$ .

Geometrically these relative coordinates mean that the phase portrait of system (2.3.7)

which we draw on the  $uv$ -plane will appear around the equilibrium point  $(x^*, y^*)$  on the  $xy$ -plane (figure 2.3.1).

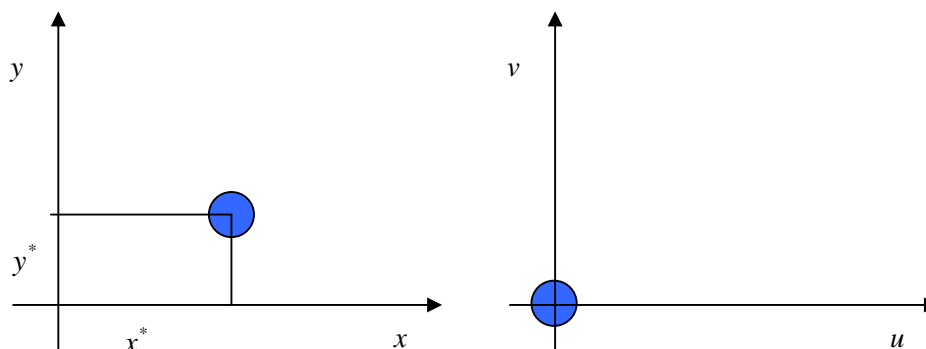

**Figure 2.3.1: Linearization of a system**

Note that formulas (2.3.3) and (2.3.4) work only for small  $h, k$ , i.e. close to the equilibrium point  $(x^*, y^*)$ .

**Conclusion:** System (2.3.7) close to the origin ( $u = 0, v = 0$ ) has a phase portrait similar to the phase portrait of system (2.3.1) close to equilibrium point  $(x^*, y^*)$ . To find the phase portrait of (2.3.1) close to equilibrium, we can first find a phase portrait of (2.3.7) and then place it around the equilibrium  $(x^*, y^*)$ .

To find the linearized system of (2.3.7) we need to find the equilibrium point  $(x^*, y^*)$  and compute the following derivatives of right hand sides of our system at this equilibrium:

$$a = \frac{\partial f}{\partial x}, \quad b = \frac{\partial f}{\partial y}, \quad c = \frac{\partial g}{\partial x}, \quad d = \frac{\partial g}{\partial y}$$

So, system (2.3.7) can be written in a matrix form as:

$$\begin{bmatrix} \frac{du}{dt} \\ \frac{dv}{dt} \end{bmatrix} = J \begin{bmatrix} u \\ v \end{bmatrix} \quad (2.3.8)$$

$$\text{Where } J = \begin{bmatrix} \frac{\partial f}{\partial x} & \frac{\partial f}{\partial y} \\ \frac{\partial g}{\partial x} & \frac{\partial g}{\partial y} \end{bmatrix} \quad (2.3.9)$$

is called the jacobian matrix of the system (2.3.1).

## 2.4 Solution of first order linear system

In this section we shall discuss about the general solution of two first order linear differential equations with the help of eigenvalues and eigenvectors of their coefficient matrix.

**Definition 2.4.1:** Given a square matrix  $A$ , suppose there is a constant  $\lambda$  and a nonzero vector  $x$  such that  $Ax = \lambda x$ , then  $\lambda$  is called an Eigenvalue of  $A$ , and  $x$  is an Eigenvector of  $A$  corresponding to  $\lambda$ .

Consider a system of two simultaneous first order linear equations

$$\begin{cases} x' = ax + by \\ y' = cx + dy \end{cases} \quad (2.4.1)$$

which can be written in matrix form as  $X' = AX$

where  $X' = \begin{bmatrix} x' \\ y' \end{bmatrix}$ ,  $A = \begin{bmatrix} a & b \\ c & d \end{bmatrix}$  and  $X = \begin{bmatrix} x \\ y \end{bmatrix}$

Here  $A = \begin{bmatrix} a & b \\ c & d \end{bmatrix}$  is called the coefficient matrix of the system (2.4.1).

From the first equation of (2.4.1) we get  $y = \frac{1}{b}(x' - ax)$ , so  $y' = \frac{1}{b}(x'' - ax')$

Therefore from the second equation of (2.4.1) we get

$$\frac{1}{b}(x'' - ax') = cx + dy$$

$$\Rightarrow x'' - (a + d)x' + (ad - bc)x = 0$$

Therefore the above system is equivalent to a second order homogeneous linear differential equation. As a result, we know that the general solution contains two linearly independent parts. As well, the solution will be consisted of some type of exponential functions. Therefore, assume that  $X = ke^{\lambda t}$  is a solution of the system, where  $k$  is a vector of coefficients (of  $x$  and  $y$ ). Substitute  $X$  and  $X' = \lambda ke^{\lambda t}$  into the equation  $X' = AX$  and we have

$$\lambda ke^{\lambda t} = Ake^{\lambda t}$$

Since  $e^{\lambda t}$  is never zero, we can always divide both sides by  $e^{\lambda t}$  and get

$$\lambda k = Ak$$

We see that this new equation is exactly the relation that defines eigenvalues and eigenvectors of the coefficient matrix  $A$ . In other words, for a function  $X = ke^{\lambda t}$  to satisfy our system of differential equations, the number  $\lambda$  must be an eigenvalue of  $A$ , and the vector  $k$  must be an eigenvector of  $A$  corresponding to  $\lambda$ . Just like the solution of a second order homogeneous linear equation, there are three possibilities, depending on the number of distinct and the type of eigenvalues of the coefficient matrix  $A$  has.

The possibilities are that  $A$  has

- I. Two distinct real eigenvalues
- II. Complex conjugate eigenvalues
- III. Repeated real eigenvalue

A related note that (from linear algebra), eigenvectors that each corresponds to a different eigenvalues are always linearly independent from each others. Consequently,



if  $\lambda_1$  and  $\lambda_2$  are two different eigenvalues, then their respective eigenvectors  $k_1$  and  $k_2$ , and therefore the corresponding solutions, are always linearly independent.

### Case I: Distinct real eigenvalues

If the coefficient matrix  $A$  has two distinct real eigenvalues  $\lambda_1$  and  $\lambda_2$ , and their respective eigenvectors are  $k_1$  and  $k_2$ . Then the  $2 \times 2$  system  $X' = AX$  has a general solution

$$X = C_1 k_1 e^{\lambda_1 t} + C_2 k_2 e^{\lambda_2 t} \quad (2.4.2)$$

**Example 2.4.1:** Consider the system

$$\begin{bmatrix} x' \\ y' \end{bmatrix} = \begin{bmatrix} 2 & 3 \\ 4 & 3 \end{bmatrix} \begin{bmatrix} x \\ y \end{bmatrix}$$

We get that the coefficient matrix has eigenvalues  $\lambda = -1$  and  $\lambda = 6$ . And they each respectively has an eigenvector  $k_1 = \begin{bmatrix} 1 \\ -1 \end{bmatrix}$  and  $k_2 = \begin{bmatrix} 3 \\ 4 \end{bmatrix}$ .

Therefore, the general solution of this system of differential equations is

$$\begin{bmatrix} x \\ y \end{bmatrix} = C_1 \begin{bmatrix} 1 \\ -1 \end{bmatrix} e^{-t} + C_2 \begin{bmatrix} 3 \\ 4 \end{bmatrix} e^{6t}$$

i.e.  $x = C_1 e^{-t} + 3C_2 e^{6t}$  and  $y = -C_1 e^{-t} + 4C_2 e^{6t}$

### Case II: Complex conjugate eigenvalues

If the coefficient matrix  $A$  has two distinct complex conjugate eigenvalues  $\lambda \pm i\mu$ . Also suppose  $k_1 = \alpha + i\beta$  and  $k_2 = \alpha - i\beta$  (in this case eigenvectors occur in conjugate Pairs) are eigenvector corresponding to the eigenvalues  $\lambda + i\mu$  and  $\lambda - i\mu$

respectively (necessarily has complex-valued entries). Then the  $2 \times 2$  system

$X' = AX$  has a real-valued general solution

$$X = C_1 e^{\lambda t} (\alpha \cos(\mu t) - \beta \sin(\mu t)) + C_2 e^{\lambda t} (\alpha \sin(\mu t) + \beta \cos(\mu t)),$$

where 
$$\alpha = \begin{bmatrix} \alpha_1 \\ \alpha_2 \end{bmatrix} \text{ and } \beta = \begin{bmatrix} \beta_1 \\ \beta_2 \end{bmatrix}$$

i.e. 
$$x = C_1 e^{\lambda t} (\alpha_1 \cos(\mu t) - \beta_1 \sin(\mu t)) + C_2 e^{\lambda t} (\alpha_1 \sin(\mu t) + \beta_1 \cos(\mu t))$$

and 
$$y = C_1 e^{\lambda t} (\alpha_2 \cos(\mu t) - \beta_2 \sin(\mu t)) + C_2 e^{\lambda t} (\alpha_2 \sin(\mu t) + \beta_2 \cos(\mu t))$$

**Example 2.4.2:** Consider the system

$$\begin{bmatrix} x' \\ y' \end{bmatrix} = \begin{bmatrix} -1 & -6 \\ 3 & 5 \end{bmatrix} \begin{bmatrix} x \\ y \end{bmatrix}$$

We get that the coefficient matrix has eigenvalues  $\lambda = 2 \pm 3i$  and the eigenvector

corresponding to  $2 + 3i$  is 
$$\begin{bmatrix} -1+i \\ 1 \end{bmatrix} = \begin{bmatrix} -1 \\ 1 \end{bmatrix} + i \begin{bmatrix} 1 \\ 0 \end{bmatrix}$$

So the general solution is

$$\begin{bmatrix} x \\ y \end{bmatrix} = C_1 e^{2t} \left\{ \begin{bmatrix} -1 \\ 1 \end{bmatrix} \cos(3t) - \begin{bmatrix} 1 \\ 0 \end{bmatrix} \sin(3t) \right\} + C_2 e^{2t} \left\{ \begin{bmatrix} -1 \\ 1 \end{bmatrix} \sin(3t) + \begin{bmatrix} 1 \\ 0 \end{bmatrix} \cos(3t) \right\}$$

$$\text{i.e., } x = C_1 e^{2t} \{-\cos(3t) - \sin(3t)\} + C_2 e^{2t} \{-\sin(3t) + \cos(3t)\}$$

$$\text{and } y = C_1 e^{2t} \{\cos(3t)\} + C_2 e^{2t} \{\sin(3t)\}$$

### Case III: Repeated real eigenvalues

Suppose the coefficient matrix  $A$  has a repeated real eigenvalues  $\lambda$ , there are 2 sub-cases.

(i) If  $\lambda$  has two linearly independent eigenvectors  $k_1$  and  $k_2$ , Then the system

$X' = AX$  has a general solution

$$X = C_1 k_1 e^{\lambda t} + C_2 k_2 e^{\lambda t}$$

(ii) If  $\lambda$ , as it usually does, only has one linearly independent eigenvector  $k$ , Then the system  $X' = AX$  has a general solution

$$X = C_1 k e^{\lambda t} + C_2 (kt + \eta) e^{\lambda t}$$

Where the second vector  $\eta$  is any solution of the non-homogeneous linear System of algebraic equations

$$(A - \lambda I)\eta = k$$

**Example 2.4.3:** Consider the system

$$\begin{bmatrix} x' \\ y' \end{bmatrix} = \begin{bmatrix} 1 & -4 \\ 4 & 7 \end{bmatrix} \begin{bmatrix} x \\ y \end{bmatrix}$$

We get that the coefficient matrix has eigenvalue  $\lambda = -3$  (repeated) and the only one

linearly independent eigenvector  $k = \begin{bmatrix} 1 \\ 1 \end{bmatrix}$ .

Now from  $(A - \lambda I)\eta = k$ , we get  $\begin{bmatrix} 4 & -4 \\ 4 & -4 \end{bmatrix} \begin{bmatrix} \eta_1 \\ \eta_2 \end{bmatrix} = \begin{bmatrix} 1 \\ 1 \end{bmatrix}$ , where  $\eta = \begin{bmatrix} \eta_1 \\ \eta_2 \end{bmatrix}$

This implies,  $\eta_1 - \eta_2 = \frac{1}{4}$

If we take  $\eta_2 = 0$ , then  $\eta_1 = \frac{1}{4}$

Therefore  $\eta = \begin{bmatrix} 1/4 \\ 0 \end{bmatrix}$

So the general solution is

$$\begin{bmatrix} x \\ y \end{bmatrix} = C_1 \begin{bmatrix} 1 \\ 1 \end{bmatrix} e^{-3t} + C_2 \left\{ \begin{bmatrix} 1 \\ 1 \end{bmatrix} t + \begin{bmatrix} 1/4 \\ 0 \end{bmatrix} \right\} e^{-3t}$$

$$\text{i.e. } x = C_1 e^{-3t} + C_2 \{t + (1/4)\} e^{-3t}$$

$$\text{and } y = C_1 e^{-3t} + C_2 t e^{-3t}$$

## 2.5 Catalogue of singularities in the phase plane.

Suppose  $\lambda_1$  and  $\lambda_2$  are the eigenvalues of the coefficient matrix of the system (2.4.1).

According to the nature of  $\lambda_1$  and  $\lambda_2$ , we consider the following three cases.

### Case I: $\lambda_1$ and $\lambda_2$ are real and distinct

In this case the general solution is

$$\begin{bmatrix} x \\ y \end{bmatrix} = C_1 k_1 e^{\lambda_1 t} + C_2 k_2 e^{\lambda_2 t} \quad (2.5.1)$$

(a)  $\lambda_1$  and  $\lambda_2$  have the same sign. Typical eigenvectors  $k_1$  and  $k_2$  are illustrated in figure 2.5.1. Suppose  $\lambda_2 < \lambda_1 < 0$ . Then from (2.5.1), for example, for  $C_1 \neq 0, C_2 = 0$ , the general solution is

$$\begin{bmatrix} x \\ y \end{bmatrix} = C_1 k_1 e^{\lambda_1 t}$$

So the solution in the phase plane simply moves along  $k_1$  towards the origin as  $t \rightarrow \infty$  in the direction shown in figure 2.5.1 along PO if  $C_1 > 0$  and along QO if  $C_1 < 0$ .

From (2.4.2) it is clear that every solution tends to  $(0,0)$  as  $t \rightarrow \infty$  since,  $\lambda_2 < \lambda_1 < 0$ ,

$$e^{\lambda_1 t} \gg e^{\lambda_2 t} \rightarrow 0 \text{ as } t \rightarrow \infty \text{ and so } \begin{bmatrix} x \\ y \end{bmatrix} \approx C_1 k_1 e^{\lambda_1 t} \text{ as } t \rightarrow \infty.$$

Thus, close enough to the origin all solutions tend to zero along  $k_1$  as shown in the figure 2.5.1. This is called a type I. With  $\lambda_1 \leq \lambda_2 < 0$  it is a stable node since all trajectories tend to  $(0,0)$  as  $t \rightarrow \infty$ . On the other hand if  $\lambda_1 \geq \lambda_2 > 0$  it is an unstable node; here all trajectories tend to  $(0,0)$  as  $t \rightarrow -\infty$ .

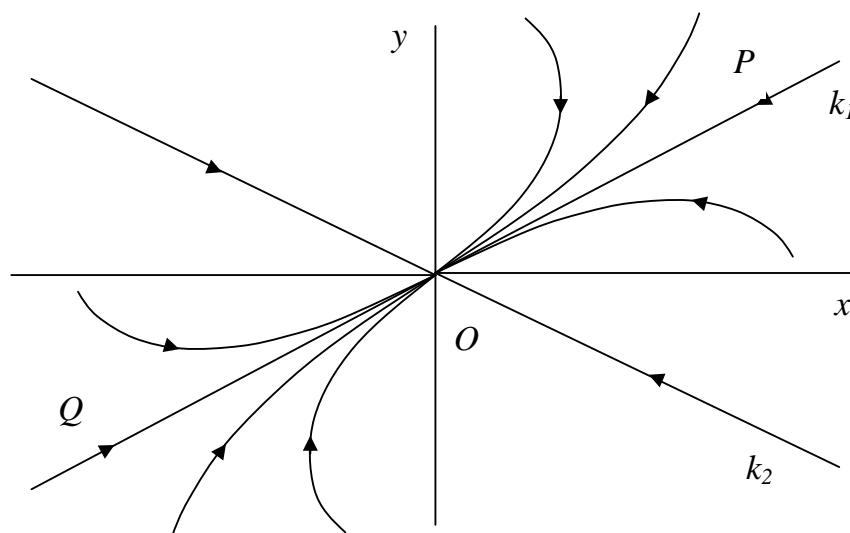

**Figure 2.5.1: Node (Type I) singularity**

(b)  $\lambda_1$  and  $\lambda_2$  have the different sign. Suppose for example  $\lambda_1 < 0 < \lambda_2$  then

$$k_1 e^{\lambda_1 t} \rightarrow 0 \text{ along } k_1 \text{ as } t \rightarrow \infty \text{ while } k_2 e^{\lambda_2 t} \rightarrow 0 \text{ along } k_2 \text{ as } t \rightarrow -\infty.$$

There are thus different direction on  $k_1$  and  $k_2$ : the solution near  $(0,0)$  are as shown in figure 2.5.2. This is a saddle point singularity. It is always unstable: except strictly along  $k_1$  any small perturbation from  $(0,0)$  grows exponentially.

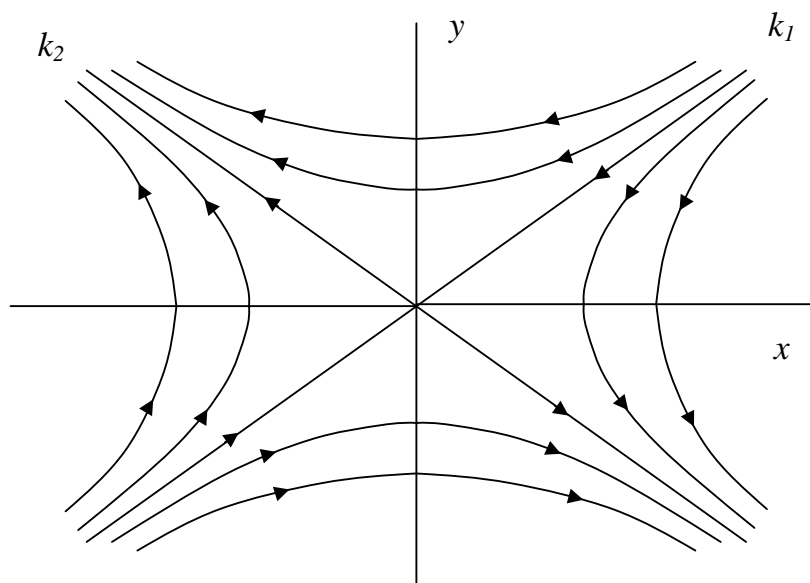

Figure 2.5.2: Saddle point singularity

**Case II:  $\lambda_1$  and  $\lambda_2$  are complex**

Suppose the eigenvalues are  $\lambda \pm i\mu$ ,  $\mu \neq 0$ . In this case the general solution is

$$\begin{bmatrix} x \\ y \end{bmatrix} = C_1 e^{\lambda t} (\alpha \cos(\mu t) - \beta \sin(\mu t)) + C_2 e^{\lambda t} (\alpha \sin(\mu t) + \beta \cos(\mu t))$$

$$\text{where } \alpha = \begin{bmatrix} \alpha_1 \\ \alpha_2 \end{bmatrix} \text{ and } \beta = \begin{bmatrix} \beta_1 \\ \beta_2 \end{bmatrix} \text{ are eigenvectors.}$$

Here the solution involve  $e^{\lambda t}$ ,  $\cos(\mu t)$  and  $\sin(\mu t)$  which implies an oscillatory approach to  $(0,0)$ .

(a)  $\lambda \neq 0$ . Here we have a spiral, which is stable if  $\lambda < 0$  and unstable if  $\lambda > 0$ .

Figure 2.5.3 illustrates a spiral singularity.

(b)  $\lambda = 0$ . In this case the phase curves are ellipses. This singularity is called a centre and is illustrated in figure 2.5.4. Centres are not stable in the usual sense; a small perturbation from one phase curve does not die out in the sense of returning to the original unperturbed curve. The perturbation simply gives another solution. In the case of centre singularities, determined by the linear approximation to  $f(x, y)$

and  $g(x, y)$ , we must look at the higher-order (than linear) terms to determine whether or not it is really a spiral and hence whether it is stable or unstable.

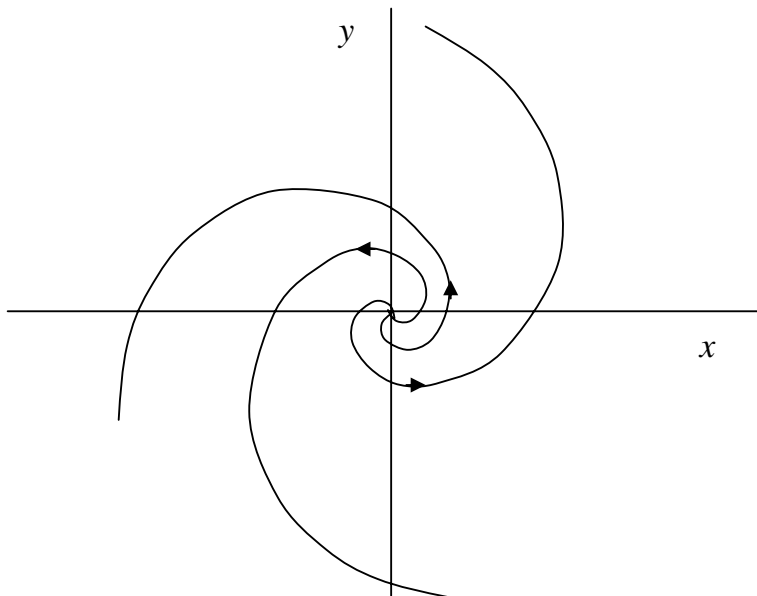

**Figure 2.5.3: Spiral singularity**

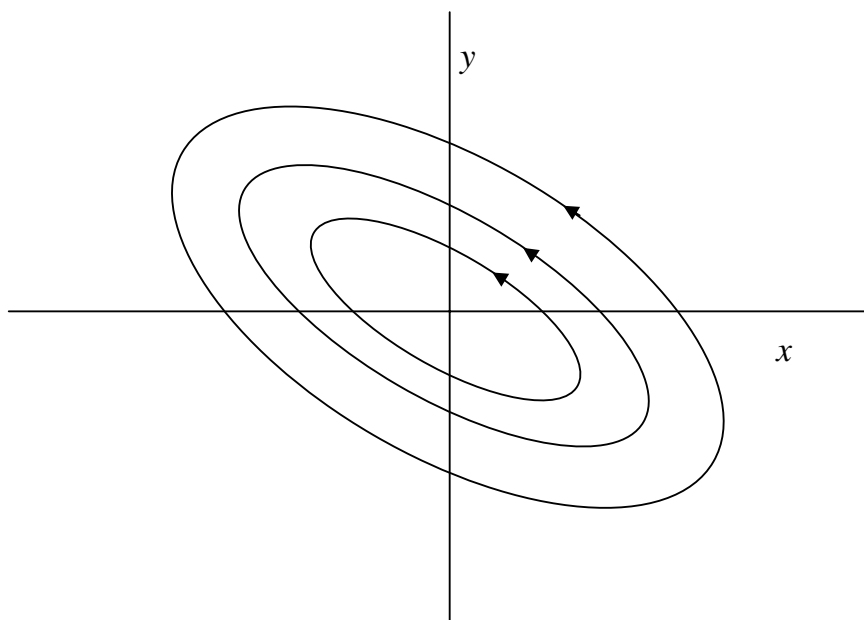

**Figure 2.5.4: Centre singularity**

**Case III:**  $\lambda_1$  and  $\lambda_2$  are real and  $\lambda_1 = \lambda_2 = \lambda$  .

In general, solutions now involve terms like  $te^{\lambda t}$  and there is only one eigenvector along which the solutions tend to  $(0,0)$  . The  $t$  in  $te^{\lambda t}$  modifies the solution away from  $(0,0)$  . It is called a node (Type II) singularity, an illustration of which is given in figure 2.5.5.

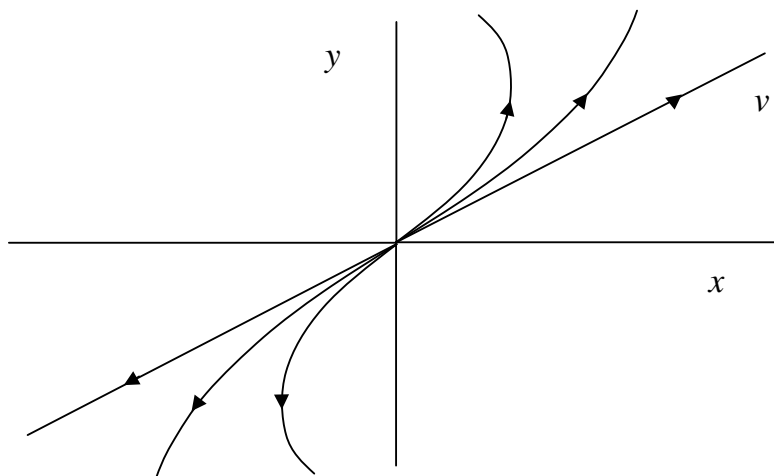

**Figure 2.5.5: Node (Type II) singularity**

(b) If the solutions do not contain the  $te^{\lambda t}$  term we have a star singularity, which may be stable or unstable, depending on the sign of  $\lambda$  . Trajectories in the vicinity of a star singularity are shown in figure 2.5.6.

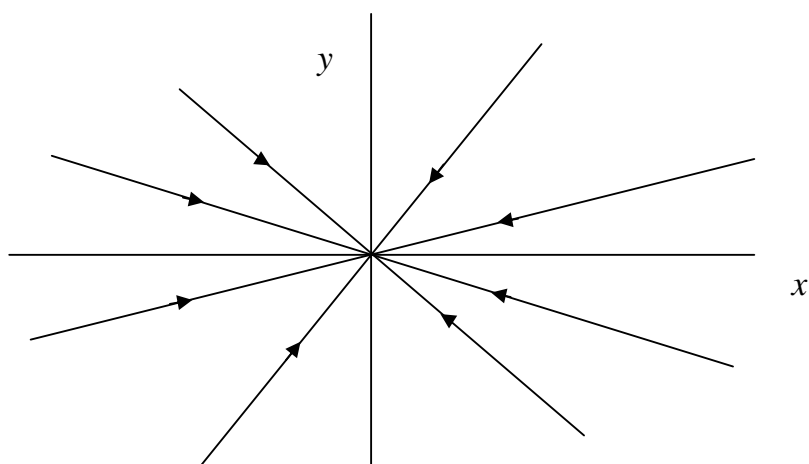

**Figure 2.5.6: Star singularity**



The singularity depends on  $a$ ,  $b$ ,  $c$  and  $d$  in the coefficient matrix  $A = \begin{bmatrix} a & b \\ c & d \end{bmatrix}$  of the system (2.4.1). Figure 2.5.7 summarizes the results in terms of the trace and determinant of  $A$ .

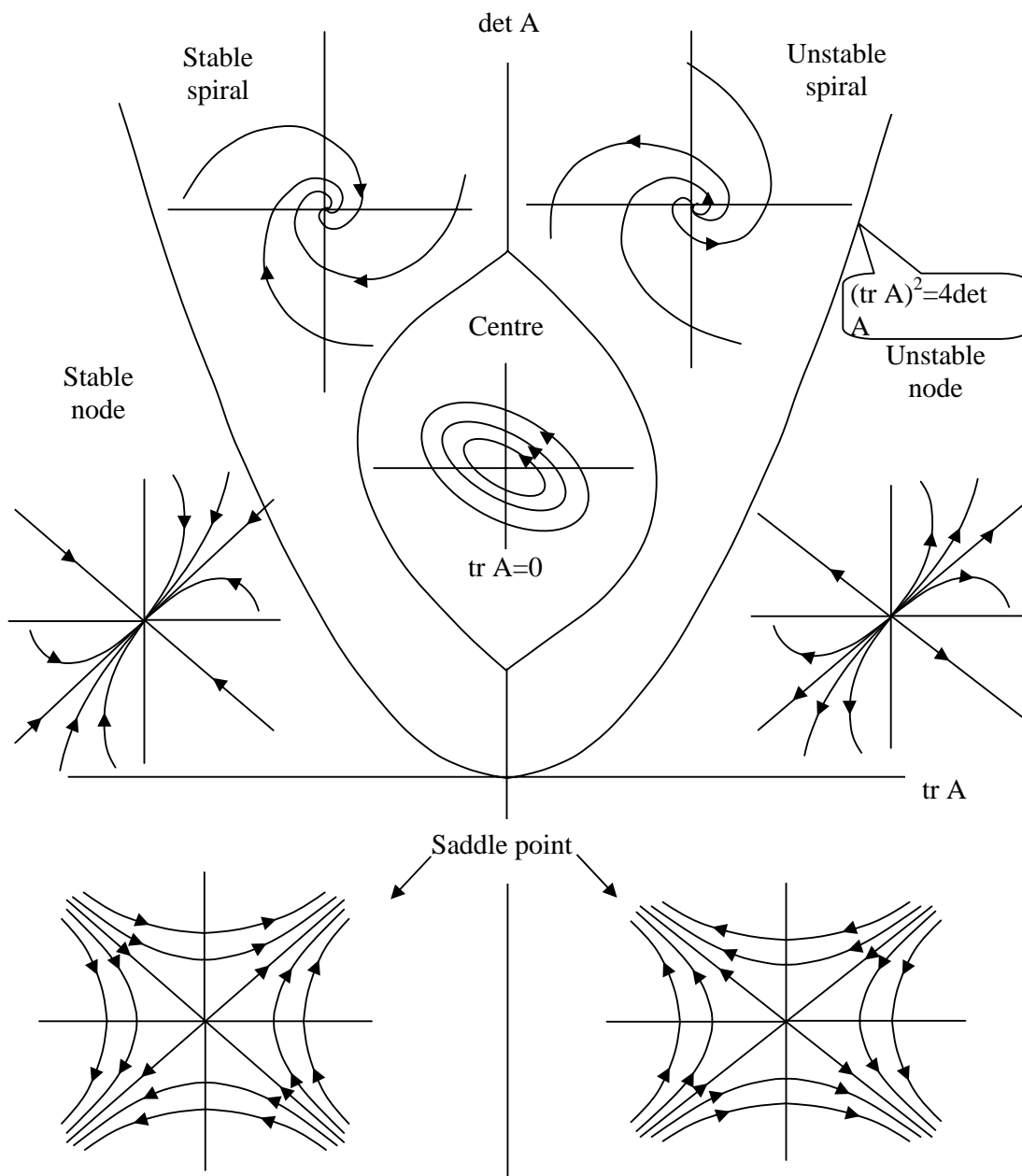

Figure 2.5.7: Summarizes of the results

## **2.6 Conclusion**

In this chapter we have given a fundamental overview of qualitative analysis of differential equations which is essential for stability analysis of mathematical models. It has been shown that how a first order nonlinear system of differential equation is approximated to a system of linear differential equation corresponding to an equilibrium point, then we have defined its jacobian matrix. Finally we have shown that the stability of the equilibrium point depends on the eigenvalues of the jacobian matrix. Eigenvalues are generally complex numbers. If real parts of all eigenvalues are negative, then the equilibrium is stable otherwise the equilibrium is unstable.

# CHAPTER THREE

## SIMPLE EPIDEMIC MODELS

### 3.1 Introduction

Millions of people in the world have been suffering over centuries through the prevalence of infectious disease. An epidemic is an unusually large, short term outbreak of a disease, for example measles, cholera, AIDS, malaria, etc.

The outbreak and spread of disease has been questioned and studied for many years. The ability to make predictions about diseases could enable scientists to evaluate inoculation or isolation plans and may have a significant effect on the mortality rate of a particular epidemic. The modeling of infectious diseases is a tool which has been used to study the mechanisms by which diseases spread, to predict the future course of an outbreak and to evaluate strategies to control an epidemic.

The first scientist who systematically tried to quantify causes of death was John Graunt in his book *Natural and Political Observations made upon the Bills of Mortality*, in 1662. The bills he studied were listings of numbers and causes of deaths published weekly. Graunt's analysis of causes of death is considered the beginning of the "theory of competing risks" which according to Daley and Gani is "a theory that is now well established among modern epidemiologists".

The earliest account of mathematical modeling of spread of disease was carried out in 1766 by Daniel Bernoulli. Trained as a physician, Bernoulli created a mathematical model to defend the practice of inoculating against smallpox. The calculations from this model showed that universal inoculation against smallpox would increase the life

expectancy from 26 years 7 months to 29 years 9 months. Daniel Bernoulli's work, of course, preceded our modern understanding of germ theory. This was soon followed by the acclaimed work of A. G. McKendrick and W. O. Kermack, whose paper A Contribution to the Mathematical Theory of Epidemics was published in 1927. A simple deterministic (compartmental) model was formulated in this paper. The model was successful in predicting the behavior of outbreaks very similar to that observed in many recorded epidemics.

In this chapter, we shall study and discuss some simple epidemic models.

### 3.2 Basic concepts

The spread of a disease depends on the model of transmission, susceptibility, infection period, resistance and many other factors. That is, usually an infectious disease spreads in a population when one or more infective enter into the population from outside. Germs of the disease coming from the last outbreak of the disease may also manage to survive within the population as a spores which are activated by nature under suitable climatic conditions.

Since a gap of time is taken place between the receipt of infection and the appearance of systems in the case of most of the infectious disease, therefore once an individual gets infected by a disease, the symptoms of the disease are manifested on the body of the person after a time interval. This time interval is called the latent or incubation period.

In a given population we assume that at time  $t$ ,  $S(t)$  denotes the number of susceptible, that is, the number of individuals in the population who can be infected,

$I(t)$  denotes the number of infected persons in the population and  $R(t)$  denotes the number of individuals removed from the disease by recovery, death, immunization or other means. Before looking at specific models, we will make the following assumptions:

- (i) The disease is transmitted by contact between the infected individual and a susceptible individual.
- (ii) There is no latent period for the disease; hence the disease is transmitted instantaneously on the contact.
- (iii) All susceptible individuals are equally susceptible and all infected individual are equally infected.

### 3.3 SI model

We consider a simple deterministic epidemic model in which there are no removals from circulation by death, recovery or isolation and everyone in the population is either susceptible to the disease or else infected with the disease.

#### 3.3.1 Model formulation

Let  $N$  be the size of a population which is considered to be fixed and  $S(t)$  and  $I(t)$  be the number of susceptible and infected individuals at time  $t$ . it is assumed that the susceptible are homogeneously mixing with each other.

Let  $S_0$  be the initial number of susceptible in the population in which a number of infected individual  $I_0$  have been introduce, so that

$$[S(t)]_{t=0} = S_0 \text{ and } [I(t)]_{t=0} = I_0$$

Then, at the initial time we have

$$S(t) + I(t) = S_0 + I_0 = \text{constant} = N \quad (3.3.1)$$

Since the population is considered to be fixed, therefore due to infection, the number of susceptible decrease and the number of infected persons increase.

If we assume that the rate of decrease of  $S(t)$ , or the rate of increase of  $I(t)$  is proportional to the product of the number of susceptible  $S(t)$  and the number of infected  $I(t)$  then,

$$\frac{dS}{dt} = -\alpha SI \quad (3.3.2)$$

and

$$\frac{dI}{dt} = \alpha SI \quad (3.3.3)$$

where  $\alpha$  is a positive constant, called the contact rate and

$$S + I = N \quad (3.3.4)$$

Now from equation (3.3.2) and (3.3.4), we get

$$\frac{dS}{dt} = -\alpha S(N - S) \quad (3.3.5)$$

which is a non-linear ordinary differential equation and it can be easily solved by the method of separation of variables.

### 3.3.2 Solution of model

From equation (3.3.5) we get

$$\frac{dS}{S(N-S)} = -\alpha dt$$

or, 
$$\left( \frac{1}{S} + \frac{1}{N-S} \right) dS = -\alpha N dt$$

Integrating both sides, we get

$$\ln S - \ln(N-S) = -\alpha N t + \ln A$$

where  $A$  is an arbitrary constant.

Now from the above equation, we get

$$S = \frac{AN}{A + e^{\alpha N t}}$$

or, 
$$A = \frac{S e^{\alpha N t}}{N - S}$$

initially, when  $t = 0$ ,  $S = S_0$ , so that

$$A = \frac{S_0}{N - S_0}$$

therefore, 
$$S = \frac{S_0 N}{S_0 + (N - S_0) e^{\alpha N t}} \quad (3.3.6)$$

and using equation (3.3.4) we get

$$I = \frac{I_0 N e^{\alpha N t}}{I_0 + (N - I_0) e^{\alpha N t}} \quad (3.3.7)$$

Equation (3.3.6) gives the number of susceptible and equation (3.3.7) gives the number of infected persons at any time  $t$ .

### 3.3.3 Interpretation

It is clear from equation (3.3.6) that

$$\text{As } t \rightarrow \infty, S(t) \rightarrow 0 \text{ and hence } I(t) \rightarrow N$$

This result shows that, ultimately all the persons will be infected.

By plotting  $S(t)$  and  $I(t)$  against  $t$  we get the graphical representation of equations (3.3.6) and (3.3.7) as follows (Here  $N = 1000$ ,  $S_0 = 990$ ,  $I_0 = 10$  and  $\alpha = 0.005$ ):

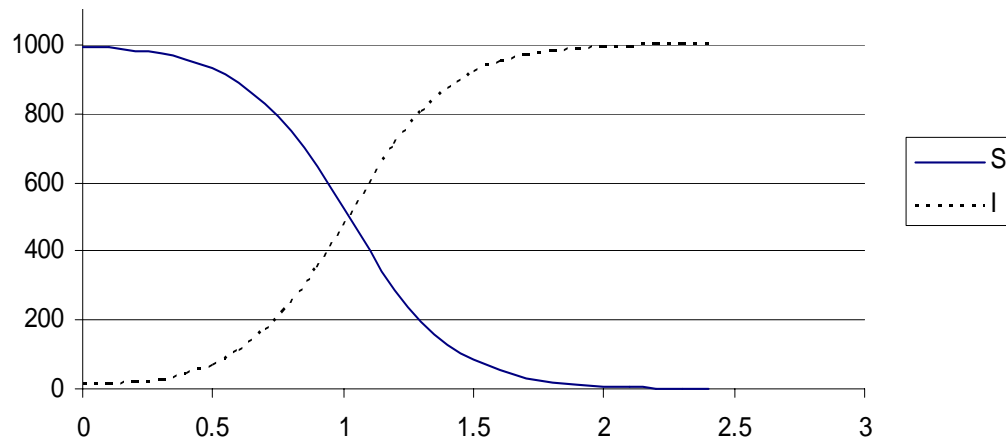

**Figure 3.3.1: Solution of SI model**

This suggests that in a large population with a small initial number of infective  $I_0$ , at first the epidemic (as measured by the total number of infective) grows exponentially. Then as fewer susceptible are available, the rate of growth decrease, but the epidemic does not stop until everyone in the population has contracted the disease.



Therefore from this model we can say that once an epidemic begins, everyone in the population ultimately contracts the disease. This is because infective remain infected forever.

In practice, the public health departments usually record the number of new cases appearing each time.

We have from equation (3.3.6)

$$-\frac{dS}{dt} = \frac{S_0 \alpha N^2 (N - S_0) e^{\alpha N t}}{\{S_0 + (N - S_0) e^{\alpha N t}\}^2} \quad (3.3.8)$$

The rate  $\frac{dS}{dt}$  is taken with a negative sign because the number of susceptible  $S$  decrease as the epidemic develops. If we draw a curve of the rate of the change of the number of susceptible  $\frac{dS}{dt}$  verses  $t$ , and the rate of change in the number of infective

$\frac{dI}{dt}$  verses time  $t$ , remembering  $\frac{dS}{dt} = -\frac{dI}{dt}$ , then we obtain a curve known as epidemic curve, which is shown in the figure 3.3.2 (Here  $N = 1000$ ,  $S_0 = 990$ ,  $I_0 = 10$  and  $\alpha = 0.005$ ).

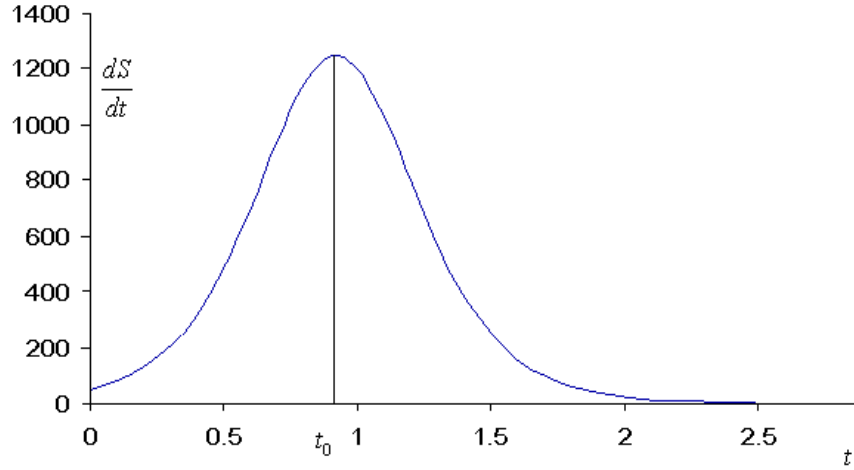

**Figure 3.3.2: Epidemic curve of SI model**

Obviously the maximum value of  $\frac{dS}{dt}$  at time  $t$  is given by  $\frac{d^2S}{dt^2} = 0$ .

Now from equation (3.3.8)

$$\begin{aligned} \frac{d}{dt} \left( \frac{dS}{dt} \right) &= - \frac{d}{dt} \left[ \frac{S_0 \alpha N^2 (N - S_0) e^{\alpha N t}}{\{S_0 + (N - S_0) e^{\alpha N t}\}^2} \right] \\ &= -S_0 \alpha N^2 (N - S_0) \frac{d}{dt} \left[ \frac{e^{\alpha N t}}{\{S_0 + (N - S_0) e^{\alpha N t}\}^2} \right] \\ &= -S_0 \alpha N^2 (N - S_0) \left[ \frac{\{S_0 + (N - S_0) e^{\alpha N t}\}^2 \cdot \alpha N e^{\alpha N t} - 2\{S_0 + (N - S_0) e^{\alpha N t}\} (N - S_0) \alpha N e^{2\alpha N t}}{\{S_0 + (N - S_0) e^{\alpha N t}\}^4} \right] \\ \therefore \frac{d^2S}{dt^2} &= - \frac{S_0 \alpha^2 N^3 (N - S_0) e^{\alpha N t}}{\{S_0 + (N - S_0) e^{\alpha N t}\}^3} [S_0 - (N - S_0) e^{\alpha N t}] \end{aligned}$$

Hence  $\frac{d^2S}{dt^2} = 0$  gives

$$S_0 = (N - S_0) \exp(\alpha N t_0)$$

or

$$t_0 = \frac{1}{\alpha N} \ln \left( \frac{S_0}{N - S_0} \right) \quad (3.3.9)$$

Hence, the epidemic curve has a maximum value at  $t_0 = \frac{1}{\alpha N} \ln \left( \frac{S_0}{N - S_0} \right)$  when the number of susceptible individuals is given by the equations (3.3.6) and (3.3.9) as.

$$S = \frac{N}{2} \quad (3.3.10)$$

and from the equation (3.3.5), we have at  $t = t_0$

$$-\frac{dS}{dt} = \alpha \left( \frac{N}{2} \right)^2 \quad (3.3.11)$$

Hence from the equations (3.3.9) to (3.3.11), we conclude that the rate of appearance of new infective is maximum at a time  $t_0 = \frac{1}{\alpha N} \ln \left( \frac{S_0}{N - S_0} \right)$ , when the density of

susceptible is  $\frac{N}{2}$  and the maximum rate at which the new cases occur is

$-\frac{dS}{dt} = \alpha \left( \frac{N}{2} \right)^2$ . That is, the rate of appearance of new cases rises rapidly to its

maximum value at a time depending on  $\alpha$ ,  $N$  and  $S_0$ , and then falls to zero, which is shown in the figure 3.3.2.

### 3.4 SIS model

In this model, we assume a susceptible person becomes infected at a rate proportional to  $SI$  and then an infected person recovers and again becomes susceptible at rate which is proportional to  $I$ .

### 3.4.1 Model formulation

Let  $N$  be the size of a population which is considered to be fixed and  $S(t)$  and  $I(t)$  be the number of susceptible and infected individuals at time  $t$ . It is assumed that the susceptible are homogeneously mixing with each other.

Let  $S_0$  be the initial number of susceptible in the population in which a number of infected individual  $I_0$  have been introduced, so that

$$[S(t)]_{t=0} = S_0 \text{ and } [I(t)]_{t=0} = I_0$$

Then, at the initial time we have

$$S(t) + I(t) = S_0 + I_0 = \text{constant} = N \quad (3.4.1)$$

The following figure shows the model structure

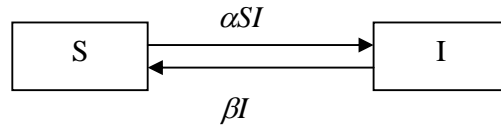

**Figure 3.4.1: Diagram of SIS model**

The basic equations in this model are given by

$$\frac{dS}{dt} = -\alpha SI + \beta I \quad (3.4.2)$$

and

$$\frac{dI}{dt} = \alpha SI - \beta I \quad (3.4.3)$$

where  $\alpha$  and  $\beta$  is a positive constant and

$$S + I = N \quad (3.4.4)$$

From the equations (3.4.3) and (3.4.4) we obtain

$$\begin{aligned}\frac{dI}{dt} &= \alpha(N - I)I - \beta I \\ &= (\alpha N - \beta)I - \alpha I^2\end{aligned}$$

Let  $K = \alpha N - \beta$ , then

$$\frac{dI}{dt} = KI - \alpha I^2$$

or

$$\frac{dI}{dt} = KI \left(1 - \frac{\alpha}{K} I\right) \quad (3.4.5)$$

### 3.4.2 Solution of model

Separating the variable of the equation (3.4.5), we get

$$\frac{dI}{I \left(1 - \frac{\alpha}{K} I\right)} = K dt$$

or

$$\left( \frac{1}{I} + \frac{1}{\frac{\alpha}{K} - I} \right) dI = K dt$$

Now integrating both sides, we get

$$\ln I - \ln \left[ \left( \frac{K}{\alpha} - I \right) \right] = Kt + \ln A$$

where  $A$  is a constant of integration.

$$\therefore \ln \left[ \frac{I}{A \left[ \left( \frac{K}{\alpha} - I \right) \right]} \right] = Kt$$

or 
$$\frac{I}{A[(K/\alpha) - I]} = e^{Kt}$$

or 
$$A = \frac{I}{[(K/\alpha) - I]e^{Kt}} \quad (3.4.6)$$

or 
$$I = A[(K/\alpha) - I]e^{Kt}$$

or 
$$I(1 + Ae^{Kt}) = A[K/\alpha]e^{Kt}$$

or 
$$I = \frac{A[K/\alpha]e^{Kt}}{1 + Ae^{Kt}} \quad (3.4.7)$$

Initially when  $t = 0$ ,  $I = I_0$  then from (3.4.6) we get

$$A = \frac{I_0}{K/\alpha - I_0}$$

So, from the equation (3.4.7) we get

$$I = \frac{I_0[K/\alpha]e^{Kt}}{(K/\alpha - I_0)\left(1 + \frac{I_0}{K/\alpha - I_0}\right)e^{Kt}}$$

or 
$$I = \frac{I_0[K/\alpha]e^{Kt}}{(K/\alpha) - I_0 + I_0e^{Kt}}$$

or 
$$I = \frac{e^{Kt}}{\frac{\alpha}{K}(e^{Kt} - 1) + \frac{1}{I_0}}, \text{ where } K \neq 0$$

When  $K = 0$ , equation (3.4.5) becomes

$$\frac{dI}{dt} = -\alpha I^2$$

or

$$-\frac{dI}{I^2} = \alpha dt$$

Integrating both sides, we get

$$\frac{1}{I} = \alpha t + B, \text{ where } B \text{ is a constant of integration.}$$

Initially, when  $t = 0$ ,  $I = I_0$  so that  $B = 1/I_0$

$$\therefore I = \frac{1}{\alpha t + 1/I_0}$$

Hence the solution of equation (3.4.5) is

$$I(t) = \begin{cases} \frac{e^{Kt}}{(\alpha/K)(e^{Kt} - 1) + (1/I_0)} & , K \neq 0 \\ \frac{1}{\alpha t + 1/I_0} & , K = 0 \end{cases} \quad (3.4.8)$$

Since  $S(t) + I(t) = N$ , i.e.,  $S(t) = N - I(t)$ , so from (3.4.8) we get

$$S(t) = \begin{cases} N - \frac{e^{Kt}}{(\alpha/K)(e^{Kt} - 1) + (1/I_0)} & , K \neq 0 \\ N - \frac{1}{\alpha t + 1/I_0} & , K = 0 \end{cases}$$

### 3.4.3 Interpretation

We have,

$$K = \alpha N - \beta$$

i.e.,

$$\frac{K}{\alpha} = N - \frac{\beta}{\alpha}$$

i.e., 
$$\frac{K}{\alpha} = N - \rho$$

where  $\rho = \frac{\beta}{\alpha}$  is known as relative removal rate

It is clear from the equation (3.4.8) that as  $t \rightarrow \infty$

$$I(t) \rightarrow K/\alpha = N - \rho, \text{ if } K > 0 \text{ i.e., } N > \rho$$

and 
$$I(t) \rightarrow 0, \text{ if } K \leq 0 \text{ i.e., } N \leq \rho$$

These results are shown in the figure 3.4.2.

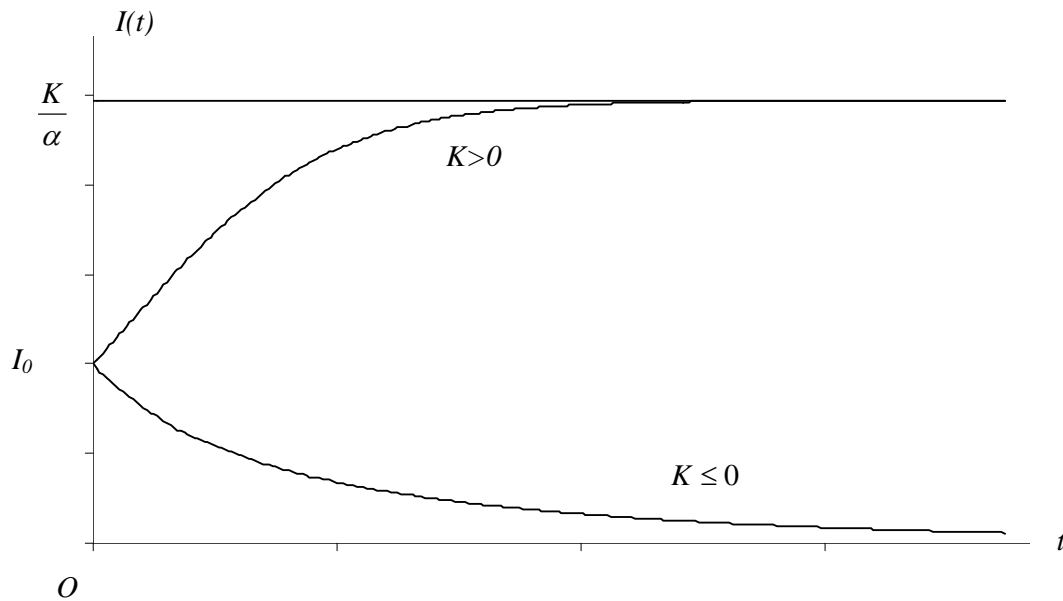

Figure 3.4.2: Solution of SIS model

**Lemma 3.4.1** If  $\alpha$  is a function of  $t$ , i.e.,  $\alpha = \alpha(t)$  then

$$I(t) = \frac{\exp\left[N \int_0^t \alpha(u) du - \beta t\right]}{\int_0^t \left[\alpha(v) \exp\left(N \int_0^v \alpha(u) du - \alpha v\right)\right] dv + \frac{1}{I_0}}$$



**Proof** In this case the basic equations of SIS model are

$$\frac{dS}{dt} = -\alpha(t)SI + \beta I \quad (3.4.9)$$

and 
$$\frac{dI}{dt} = \alpha(t)SI - \beta I \quad (3.4.10)$$

with 
$$S(t) + I(t) = S_0 + I_0 = N \quad (3.4.11)$$

From equation (3.4.10) and (3.4.11) we get

$$\frac{dI}{dt} = \alpha(t)(N - I)I - \beta I$$

or 
$$\frac{dI}{dt} = [\alpha(t)N - \beta]I - \alpha(t)I^2$$

or 
$$\frac{1}{I^2} \frac{dI}{dt} = [\alpha(t)N - \beta] \frac{1}{I} - \alpha(t) \quad (3.4.12)$$

Let  $X = \frac{1}{I}$ , then  $\frac{dX}{dt} = -\frac{1}{I^2} \frac{dI}{dt}$ , so the equation (3.4.12) becomes

$$\frac{dX}{dt} + [\alpha(t)N - \beta]X = \alpha(t) \quad (3.4.13)$$

Now the equation (3.4.13) is linear differential equation.

$$\therefore \text{Integrating factor (I.F)} = e^{\int (\alpha(t)N - \beta) dt} = \exp\left[N \int \alpha(t) dt - \beta t\right]$$

So the solution is  $X \exp\left(N \int \alpha(t) dt - \beta t\right) = \int \alpha(t) \exp\left(N \int \alpha(t) dt - \beta t\right) dt + C$

Now taking the limit of integration from  $t = 0$  to  $t = t$ , we get

$$X \exp \left[ N \int_0^t \alpha(u) du - \beta t \right] = \int_0^t \alpha(v) \exp \left[ N \int_0^v \alpha(u) du - \beta v \right] dv + X_0$$

But  $X(t) = \frac{1}{I(t)}$  so that  $X_0 = \frac{1}{I_0}$

$$\therefore I(t) = \frac{\exp \left[ N \int_0^t \alpha(u) du - \beta t \right]}{\int_0^t \left[ \alpha(v) \exp \left( N \int_0^v \alpha(u) du - \alpha v \right) \right] dv + \frac{1}{I_0}}$$

Hence the proof.

**Definition:** The individuals are said to be carrier who, although apparently healthy themselves, harbor infection which can be transmitted to others.

**Lemma 3.4.2** If the infection is spread only by a constant number  $C$  of carriers in the SIS model, then

$$I(t) = \left( I_0 - \frac{\alpha CN}{\alpha C + \beta} \right) \exp \{ -(\alpha C + \beta)t \} + \frac{\alpha CN}{\alpha C + \beta}$$

**Proof:** In the SIS model, the infection is spread only by a constant number  $C$  of carrier, so the model equation becomes:

$$\frac{dS}{dt} = -\alpha CS + \beta I \quad (3.4.14)$$

and

$$\frac{dI}{dt} = \alpha CS - \beta I \quad (3.4.15)$$

where  $S(0) = S_0$ ,  $I(0) = I_0$  and

$$S(t) + I(t) = N \quad (3.4.16)$$

From the equation (3.4.15) and (3.4.16) we get

$$\frac{dI}{dt} = \alpha C(N - I) - \beta I$$

or 
$$\frac{dI}{dt} = \alpha CN - (\alpha CN + \beta)I$$

or 
$$\frac{dI}{dt} = (\alpha C + \beta) \left( \frac{\alpha CN}{\alpha C + \beta} - I \right)$$

or 
$$\frac{dI}{I - \frac{\alpha CN}{\alpha C + \beta}} = -(\alpha C + \beta)dt$$

Integrating both sides we get

$$\ln \left[ I - \frac{\alpha CN}{\alpha C + \beta} \right] = -(\alpha C + \beta)t + D, \quad \text{where } D \text{ is a constant}$$

Initially, when  $t = 0$ ,  $I = I_0$ , then

$$D = \ln \left[ I_0 - \frac{\alpha CN}{\alpha C + \beta} \right]$$

$\therefore$  
$$\ln \left[ I - \frac{\alpha CN}{\alpha C + \beta} \right] = -(\alpha C + \beta)t + \ln \left[ I_0 - \frac{\alpha CN}{\alpha C + \beta} \right]$$

or 
$$\ln \left[ \left( I - \frac{\alpha CN}{\alpha C + \beta} \right) / \left( I_0 - \frac{\alpha CN}{\alpha C + \beta} \right) \right] = -(\alpha C + \beta)t$$

or 
$$\left( I - \frac{\alpha CN}{\alpha C + \beta} \right) / \left( I_0 - \frac{\alpha CN}{\alpha C + \beta} \right) = \exp(-(\alpha C + \beta)t)$$

$$\therefore I(t) = \left( I_0 - \frac{\alpha CN}{\alpha C + \beta} \right) \exp\{-(\alpha C + \beta)t\} + \frac{\alpha CN}{\alpha C + \beta}$$

Hence the proof.

**Problem 3.4.1** If in the *SIS* model, infection is spread both by infective and by constant number of carrier then find  $I(t)$ .

**Solution:** Let the constant number of carrier be  $C$  and  $S(t)$  and  $I(t)$  be the number of susceptible and infected persons. Also we assume that the fixed population size is  $N$ .

Then the model equations are

$$\frac{dS}{dt} = -\alpha S(I + C) + \beta I \quad (3.4.17)$$

and 
$$\frac{dI}{dt} = \alpha S(I + C) - \beta I \quad (3.4.18)$$

where  $S(0) = S_0$  and  $I(0) = I_0$ . Therefore

$$S(t) + I(t) = S_0 + I_0 = N \quad (3.4.19)$$

Now from equation (3.4.18) and (3.4.19) we get

$$\begin{aligned} \frac{dI}{dt} &= \alpha(N - I)(I + C) - \beta I \\ &= \alpha CN + \alpha(N - C - \rho)I - \alpha I^2 \quad (\text{Here } \rho = \beta / \alpha) \end{aligned}$$

Multiplying both sides by  $\alpha$  we get

$$\alpha \frac{dI}{dt} = \alpha^2 CN + \alpha^2 (N - C - \rho)I - \alpha^2 I^2$$

or 
$$\frac{d}{dt}(\alpha I) = \alpha^2 CN + \alpha(N - C - \rho)(\alpha I) - (\alpha I)^2$$

Let 
$$X = \alpha I$$

$$\therefore \frac{dX}{dt} = \alpha^2 CN + \alpha(N - C - \rho)X - X^2$$

or 
$$\frac{dX}{dt} = \alpha^2 CN + \alpha(N - C - \rho)X - X^2$$

or 
$$\frac{dX}{dt} = (x_1 - X)(x_2 + X)$$

where 
$$x_1 = \frac{1}{2}\alpha \left[ \{(N - C - \rho)^2 + 4CN\}^{1/2} + (N - C - \rho) \right]$$

and 
$$x_2 = \frac{1}{2}\alpha \left[ \{(N - C - \rho)^2 + 4CN\}^{1/2} - (N - C - \rho) \right]$$

Now separating the variables, we get

$$\frac{dX}{(x_1 - X)(x_2 + X)} = dt$$

or 
$$\frac{1}{x_1 + x_2} \left[ \frac{1}{x_1 - X} + \frac{1}{x_2 + X} \right] dX = dt$$

or 
$$\left[ \frac{1}{x_1 - X} + \frac{1}{x_2 + X} \right] dX = (x_1 + x_2) dt$$

Integrating both sides, we get

$$-\ln(x_1 - X) + \ln(x_2 + X) = (x_1 + x_2)t + D, \text{ where } D \text{ is a constant.}$$

or 
$$\ln\left(\frac{x_2 + X}{x_1 - X}\right) = (x_1 + x_2)t + D$$

Initially when  $t=0$ ,  $I = I_0$ , i.e.,  $X = X_0 = \alpha I_0$  then we get

$$D = \ln\left(\frac{x_2 + X_0}{x_1 - X_0}\right)$$

$\therefore$  
$$\ln\left(\frac{x_2 + X}{x_1 - X}\right) = (x_1 + x_2)t + \ln\left(\frac{x_2 + X_0}{x_1 - X_0}\right)$$

or 
$$\ln\left(\frac{x_2 + X}{x_1 - X}\right) - \ln\left(\frac{x_2 + X_0}{x_1 - X_0}\right) = (x_1 + x_2)t$$

or 
$$\ln\left(\frac{(x_2 + X)(x_1 - X_0)}{(x_1 - X)(x_2 + X_0)}\right) = (x_1 + x_2)t$$

or 
$$\frac{(x_2 + X)(x_1 - X_0)}{(x_1 - X)(x_2 + X_0)} = \exp((x_1 + x_2)t)$$

or 
$$\frac{(x_2 + X)}{(x_1 - X)} = \frac{x_2 + X_0}{x_1 - X_0} \exp((x_1 + x_2)t)$$

or 
$$x_2 + X = x_1 \frac{x_2 + X_0}{x_1 - X_0} \exp((x_1 + x_2)t) - X \frac{x_2 + X_0}{x_1 - X_0} \exp((x_1 + x_2)t)$$

or 
$$X \left( \frac{x_2 + X_0}{x_1 - X_0} \exp((x_1 + x_2)t) + 1 \right) = x_1 \frac{x_2 + X_0}{x_1 - X_0} \exp((x_1 + x_2)t) - x_2$$

$$\text{or } X = \frac{x_1 \frac{x_2 + X_0}{x_1 - X_0} \exp((x_1 + x_2)t) - x_2}{\frac{x_2 + X_0}{x_1 - X_0} \exp((x_1 + x_2)t) + 1}$$

$$\therefore I(t) = \frac{1}{\alpha} \cdot \frac{x_1 \frac{x_2 + \alpha I_0}{x_1 - \alpha I_0} \exp((x_1 + x_2)t) - x_2}{\frac{x_2 + \alpha I_0}{x_1 - \alpha I_0} \exp((x_1 + x_2)t) + 1} \quad [ \because X = \alpha I ]$$

$$\text{where } x_1 = \frac{1}{2} \alpha \left[ \{(N - C - \rho)^2 + 4CN\}^{1/2} + (N - C - \rho) \right]$$

$$\text{and } x_2 = \frac{1}{2} \alpha \left[ \{(N - C - \rho)^2 + 4CN\}^{1/2} - (N - C - \rho) \right]$$

### 3.5 SIR model

In general, it is difficult to know in advance when a susceptible becomes infected. The existence of the disease only becomes known when symptoms appear. In this case the infectives are removed from the population either by death, isolation or recovery with a subsequent immunity to disease. As far as transmission of disease is concerned, recovery is a comparatively unimportant even that happens in some cases

#### 3.5.1 Model formulation

Suppose the disease is such that the population can be divided into three distinct classes: the susceptible,  $S$ , who can catch the disease; the infective,  $I$ , who have the disease and can transmit it; and the removed class,  $R$ , namely, those who have either had the disease, or are recovered, immune or isolated until recovered. The progress of individuals is schematically represented by figure 3.5.1.

Such models are often called *SIR* models. The number of classes depends on the disease. *SI* models, for example, have only susceptible and infected classes while *SEIR* models have a susceptible class, *S*, a class in which the disease is latent, *E*, an infectious class, *I*, and a recovered or dead class, *R*.

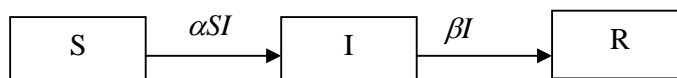

**Figure 3.5.1: Diagram of SIR model**

The assumptions made about the transmission of the infection and incubation period are crucial in any model; these are reflected in the terms in the equations and the parameters. With  $S(t)$ ,  $I(t)$  and  $R(t)$  as the number of individuals in each class we assume here that:

- (i) The gain in the infective class is at a rate proportional to the number of infective and susceptible, that is,  $\alpha SI$ , where  $\alpha > 0$  is a constant parameter. The susceptible are lost at the same rate.
- (ii) The rate of removal of infective to the removed class is proportional to the number of infective, that is,  $\beta I$  where  $\beta > 0$  is a constant;  $1/\beta$  is a measure of the time spent in the infectious state.
- (iii) The incubation period is short enough to be negligible; that is, a susceptible who contracts the disease is infective right away

We now consider the various classes as uniformly mixed; that is, every pair of individuals has equal probability of coming into contact with one another. The model mechanism based on the above assumptions is then



$$\frac{dS}{dt} = -\alpha SI \quad (3.5.2)$$

$$\frac{dI}{dt} = \alpha SI - \beta I = \alpha I(S - \rho) \quad (3.5.3)$$

where  $\rho = \beta / \alpha$

$$\frac{dR}{dt} = \beta I \quad (3.5.4)$$

where  $\alpha > 0$  is the infection rate and  $\beta > 0$  is removal rate of infective. This is the classic Kermack–McKendrick (1927) model. We are, of course, only interested in nonnegative solutions for  $S$ ,  $I$  and  $R$ . This is a basic model but, even so, we can make some highly relevant general comments about epidemics and, in fact, adequately describe some specific epidemics with such a model.

The constant population size is built into the system (3.5.2)–(3.5.4) since, on adding the equations,

$$\frac{dS}{dt} + \frac{dI}{dt} + \frac{dR}{dt} = 0 \Rightarrow S(t) + I(t) + R(t) = N \quad (3.5.5)$$

where  $N$  is the total size of the population. Thus,  $S$ ,  $I$  and  $R$  are all bounded above by  $N$ . The mathematical formulation of the epidemic problem is completed given initial conditions such as

$$[S(t)]_{t=0} = S_0 > 0, [I(t)]_{t=0} = I_0 > 0 \text{ and } [R(t)]_{t=0} = R_0 = 0$$

From the equation (3.5.3) it is clear that no epidemic (The term ‘epidemic’ means that  $I(t) > I_0$  for some  $t > 0$ ) can start unless  $\rho < S_0$ , as for epidemic the necessary and sufficient condition is  $\left[ \frac{dI}{dt} \right]_{t=0} > 0$ . Therefore,  $\rho = S_0$  gives a threshold density of susceptible.

### 3.5.2 Solution of model

From equation (3.5.2) and (3.5.4), we have

$$\frac{dS}{dR} = -\frac{\alpha}{\beta} S = -\frac{S}{\rho} \quad (3.5.6)$$

where  $\rho = \beta/\alpha$  is called the relative or effective removal rate, that is the ratio of the rate at which individuals are removed from the infected category to the rate at which they are added to the same category.

Integrating both sides of (3.5.6), we obtain

$$\ln S = -\frac{R}{\rho} + D$$

where D is a constant of integration.

Initially when  $t = 0$ ,  $S(t) = S_0$  and  $R(t) = 0$  then  $D = \ln S_0$

$$\therefore \ln S = -\frac{R}{\rho} + \ln S_0$$

$$\text{i.e.,} \quad S = S_0 \exp(-R/\rho) \quad (3.5.7)$$

Now from (3.5.4), (3.5.5) and (3.5.7), we have

$$dt = \frac{dR}{\beta(N - S_0 \exp(-R/\rho) - R)}$$

Integrating both sides between the limit of integration from  $R=0$  to  $R=R$ , we get

$$t = \frac{1}{\beta} \int_0^R \frac{dR}{N - S_0 \exp(-R/\rho) - R} \quad (3.5.8)$$

In general, this has to be integrated numerically. From (3.5.7) and (3.5.8), we can obtain  $R$  and  $S$  as implicit function of  $t$ . We can prepare numerical table for various values of  $\rho$ ,  $S_0$  and  $I_0$ .

### 3.5.3 Interpretation

From equation (3.5.2), it is clear that  $\frac{dS}{dt} < 0$  for all  $t \geq 0$ , it follows that  $S$  is monotonically decreasing function of  $t$ .

From equation (3.5.3), it is clear that  $\left[ \frac{dI}{dt} \right]_{t=0} < 0$  if  $S_0 < \rho$  and also we have  $S \leq S_0$

( $\because S$  is monotonically decreasing function of  $t$ ). Thus we have  $\left[ \frac{dI}{dt} \right]_{t=0} < 0$  if

$S \leq S_0 < \rho$ . Therefore  $\frac{dI}{dt} < 0$  for all  $t$  when  $S_0 < \rho$ , which gives that  $I(t)$  is monotonically decreasing function of  $t$  when  $S_0 < \rho$ . This shows that no epidemic can even start to build up unless  $S_0 < \rho$ .

This implies that there is a critical (threshold) value which the initial number of susceptible must exceed to enable the epidemic to spread.

Here  $\rho$  is the threshold number of susceptible. At the initial stage if only a trace of infection is present, then  $I_0 \approx 0$ , i.e.,  $S_0 \approx N$ .

In this case the threshold number  $\rho = S_0 \approx N$ . If  $N < \rho$ , the initial trace of infection will be removed faster than it can communicated to others. If  $N > \rho$ , an epidemic occur, even only a minute amount of infection is present to being with.

### 3.5.4 Asymptotic behavior of the solution

Since  $S(t)$  is monotonically decreasing function of  $t$  and is also bounded below ( $\because S(t) \geq 0$ ), we find that

$$\lim_{t \rightarrow \infty} S(t) = S_{\infty} \text{ exists.}$$

Also from equation (3.5.4), it is clear that  $R(t)$  is a monotonically increasing function of  $t$  and is bounded above ( $\because R(t) \leq N$ )

Therefore 
$$\lim_{t \rightarrow \infty} R(t) = R_{\infty} \text{ exists.}$$

Again since from the equation (3.5.5),  $I(t) = N - S(t) - R(t)$

Therefore 
$$\lim_{t \rightarrow \infty} I(t) = I_{\infty} \text{ also exists.}$$

The quantities  $S_{\infty}$ ,  $I_{\infty}$  and  $R_{\infty}$  are called ultimate densities of the classes of susceptible, infective and removals respectively. These are important because they determine how the epidemic will ultimately behave.

If  $S_0 < \rho$ , then  $I(t)$  monotonically decreases to  $I_{\infty}$ . If  $S_0 > \rho$ , then  $I(t)$  initially increases and continues to increase till  $S$  decreases to  $\rho$  and after that  $I(t)$  decreases to  $I_{\infty}$ . The figure 3.5.2 shows the graph of  $I(t)$  with the variation of  $t$ .

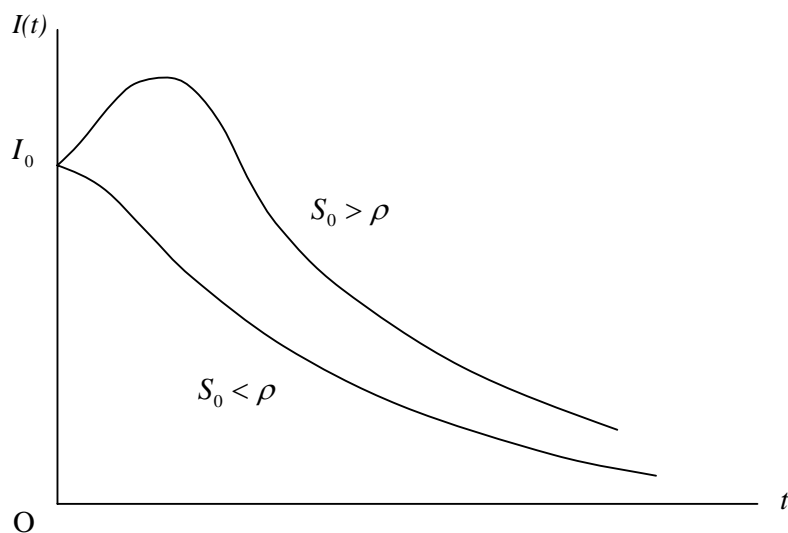

**Figure 3.5.2: Graph of  $I(t)$**

Since  $S_\infty > 0$ , then there will always be susceptible in the population and some individuals will escape infection. Thus, the ultimate density of susceptible is non-zero, i.e., some susceptible will escape the disease altogether. Hence, the spread of the disease will not stop altogether for the lack of susceptible. The figure 3.5.3 shows the graph of  $S(t)$  with the variation of  $t$ .

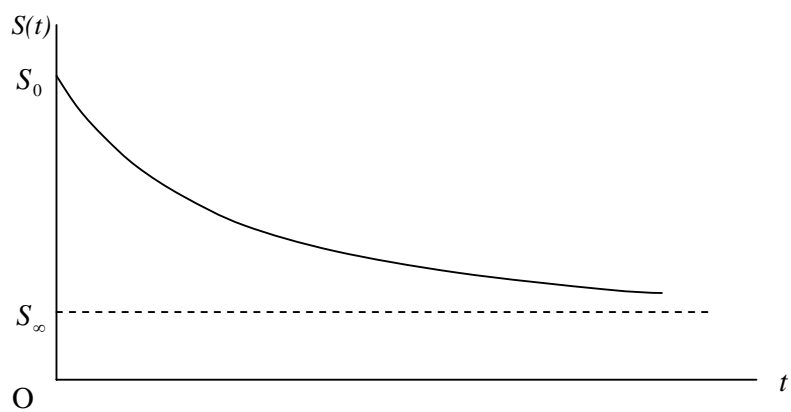

**Figure 3.5.3: Graph of  $S(t)$**

Also from equation (3.5.4), it is clear that  $R(t)$  is a monotonically increasing function of  $t$ . The figure 3.5.4 shows the graph of  $R(t)$  with the variation of  $t$ .

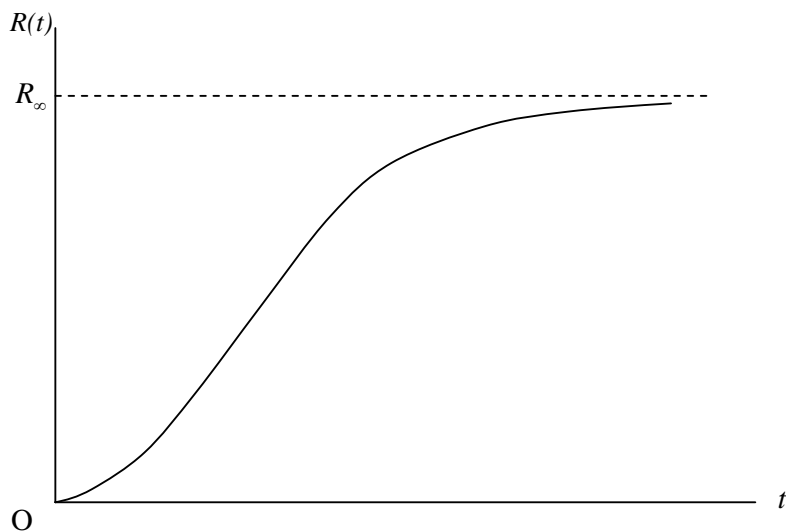

**Figure 3.5.4: Graph of  $R(t)$**

Now from equation (3.5.2) and (3.5.4) we get

$$\frac{dI}{dS} = -1 + \frac{\rho}{S}$$

or,

$$dI = \rho \frac{dS}{S} - dS$$

Integrating both sides, we obtain

$$I = \rho \ln S - S + E$$

where  $E$  is constant of integration.

Initially, when  $t = 0$ ,  $I = I_0$  and  $S = S_0$ , then

$$E = I_0 + S_0 + \rho \ln S_0$$

$$\therefore I = I_0 + S_0 - S + \rho \ln(S/S_0)$$

$$\text{or, } I = N - S + \rho \ln(S/S_0)$$

Dividing both sides by  $N$ , we get

$$\frac{I}{N} = 1 - \frac{S}{N} + \frac{\rho}{N} \ln\left(\frac{S/N}{S_0/N}\right)$$

$$\text{or } \bar{I} = 1 - \bar{S} - \bar{\rho} \ln\left(\frac{\bar{S}}{\bar{S}_0}\right) \quad (3.5.9)$$

where  $\bar{I} = I/N$ ,  $\bar{S} = S/N$ ,  $\bar{\rho} = \rho/N$  and  $\bar{S}_0 = S_0/N$

Since  $S > 0$  for all  $t$  and  $S(t) + I(t) + R(t) = N$ , so  $\bar{S}$  is always decreasing. If we draw a graph of equation (3.5.9) in the  $\bar{S}\bar{I}$ -plane (see figure 3.5.5), we get the curves

which are described from right to left and continue to move to left till  $\frac{dS}{dt} = 0$  i.e., till

$I = 0$ , when  $\frac{dI}{dt}$  and  $\frac{dR}{dt}$  also become zero. Therefore  $I_\infty = 0$  and  $S_\infty + R_\infty = N$ .

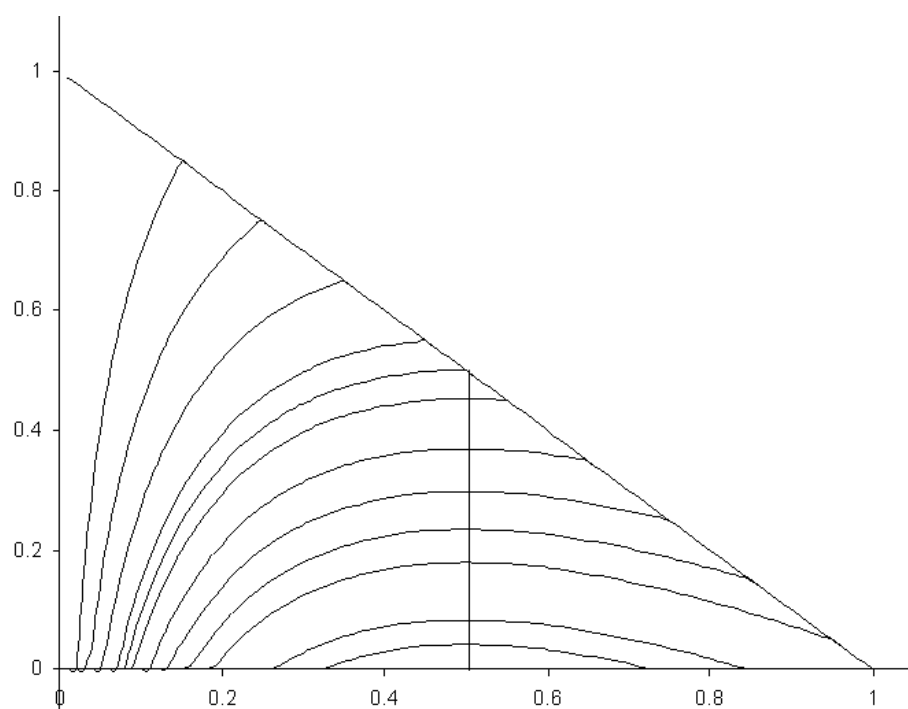

**Figure 3.5.5: Graph of equation (3.5.9)**

Thus,  $R_\infty / N$  may be regarded as a measure of the intensity of the epidemic since this gives the ultimate proportion of the population which contract the disease. The maximum number of infective occurs when  $\bar{S} = \bar{\rho}$ , and this position is independent of  $\bar{S}_0$ .

Differentiating both sides of (3.5.9) w.r.t  $\bar{S}$ , we get

$$\frac{d\bar{I}}{d\bar{S}} = -1 + \bar{\rho} \frac{1}{\bar{S}/\bar{S}_0} \cdot \frac{1}{\bar{S}_0}$$

or 
$$\frac{d\bar{I}}{d\bar{S}} = -1 + \frac{\bar{\rho}}{\bar{S}} \tag{3.5.10}$$



For maximum or minimum value of  $\bar{I}$ , we have

$$\frac{d\bar{I}}{d\bar{S}} = 0$$

i.e., 
$$-1 + \frac{\bar{\rho}}{\bar{S}} = 0$$

or 
$$\bar{S} = \bar{\rho}$$

Again differentiating both sides of (3.5.10) w.r.t  $\bar{S}$ , we get

$$\frac{d^2\bar{I}}{d\bar{S}^2} = -\frac{\bar{\rho}}{\bar{S}^2} \quad \text{which is always negative}$$

Thus, the maximum number of infective occur when  $\bar{S} = \bar{\rho}$ , i.e.,  $S = \rho$ .

In the figure 3.5.5 we now observe the behavior of curves on either sides of the line  $\bar{S} = \bar{\rho}$ . If we take the initial point  $(\bar{S}_0, \bar{I}_0)$  to the left of the line  $\bar{S} = \bar{\rho}$ , the number of infective I decrease and falls steadily to zero. On the other hand if  $(\bar{S}_0, \bar{I}_0)$  is on the right of the line  $\bar{S} = \bar{\rho}$ , the number of infective first increases and then decrease to zero.

### 3.5.5 Approximate solution

Let us see the results that can be obtained without numerical integration.

Since from the equation (3.5.7), we have

$$S = S_0 \exp(-R/\rho)$$

So, the equation (3.5.4) can be written as

$$\frac{dR}{dt} = \beta(N - S - R)$$

or 
$$\frac{dR}{dt} = \beta(N - S_0 e^{-R/\rho} - R)$$

Now if  $\rho$  is large and  $R/\rho$  is small, then (neglecting 3rd and higher power of  $R/\rho$ )

$$e^{-R/\rho} = 1 - \frac{R}{\rho} + \frac{R^2}{2\rho^2}$$

$$\begin{aligned} \therefore \frac{dR}{dt} &= \beta \left[ N - R - S_0 \left( 1 - \frac{R}{\rho} + \frac{R^2}{2\rho^2} \right) \right] \\ &= \beta \left[ (N - S_0) + \left( \frac{S_0}{\rho} - 1 \right) R - \frac{S_0 R^2}{2\rho^2} \right] \\ &= \beta \left[ I_0 - \frac{S_0}{2\rho^2} \left\{ R^2 - \frac{2\rho^2}{S_0} \left( \frac{S_0}{\rho} - 1 \right) R \right\} \right] \\ &= \beta \left[ I_0 - \frac{S_0}{2\rho^2} \left\{ R^2 - \frac{2\rho^2}{S_0} \left( \frac{S_0}{\rho} - 1 \right) R + \frac{\rho^4}{S_0^2} \left( \frac{S_0}{\rho} - 1 \right)^2 - \frac{\rho^4}{S_0^2} \left( \frac{S_0}{\rho} - 1 \right)^2 \right\} \right] \\ &= \beta \left[ I_0 + \frac{\rho^2}{2S_0} \left( \frac{S_0}{\rho} - 1 \right)^2 - \frac{S_0}{2\rho^2} \left\{ R - \frac{\rho^2}{S_0} \left( \frac{S_0}{\rho} - 1 \right) \right\}^2 \right] \\ &= \frac{\beta S_0}{2\rho^2} \left[ \frac{2I_0 \rho^2}{S_0} + \frac{\rho^4}{S_0^2} \left( \frac{S_0}{\rho} - 1 \right)^2 - \left\{ R - \frac{\rho^2}{S_0} \left( \frac{S_0}{\rho} - 1 \right) \right\}^2 \right] \end{aligned}$$

$$= \frac{\beta S_0}{2\rho^2} \left[ \frac{\rho^4}{S_0^2} \left\{ \left( \frac{S_0}{\rho} - 1 \right)^2 + \frac{2S_0 I_0}{\rho^2} \right\} - \left\{ R - \frac{\rho^2}{S_0} \left( \frac{S_0}{\rho} - 1 \right) \right\}^2 \right]$$

$$\therefore \frac{dR}{dt} = \frac{\beta S_0}{2\rho^2} \left[ \frac{\rho^4 A^2}{S_0^2} - \left\{ R - \frac{\rho^2}{S_0} \left( \frac{S_0}{\rho} - 1 \right) \right\}^2 \right]$$

$$\text{where } A = \left\{ \left( \frac{S_0}{\rho} - 1 \right)^2 + \frac{2S_0 I_0}{\rho^2} \right\}^{1/2}$$

Now separating the variables, we get

$$\frac{\beta S_0}{2\rho^2} dt = \frac{dR}{\left( \frac{\rho^2 A}{S_0} \right)^2 - \left\{ R - \frac{\rho^2}{S_0} \left( \frac{S_0}{\rho} - 1 \right) \right\}^2}$$

Integrating both sides, we get

$$\frac{\beta S_0}{2\rho^2} \int_0^t dt = \int_0^R \frac{dR}{\left( \frac{\rho^2 A}{S_0} \right)^2 - \left\{ R - \frac{\rho^2}{S_0} \left( \frac{S_0}{\rho} - 1 \right) \right\}^2}$$

$$\text{or } \frac{\beta S_0}{2\rho^2} t = \frac{S_0}{\rho^2 A} \left[ \tanh^{-1} \left( \frac{R - \frac{\rho^2}{S_0} \left( \frac{S_0}{\rho} - 1 \right)}{\frac{\rho^2 A}{S_0}} \right) \right]_0^R$$

$$\text{or } \frac{A\beta}{2} t = \tanh^{-1} \left[ \frac{S_0}{\rho^2 A} \left\{ R - \frac{\rho^2}{S_0} \left( \frac{S_0}{\rho} - 1 \right) \right\} \right] + \tanh^{-1} \left[ \frac{1}{A} \left( \frac{S_0}{\rho} - 1 \right) \right]$$

$$\text{or } \frac{A\beta}{2} t = \tanh^{-1} \left[ \frac{S_0}{\rho^2 A} \left\{ R - \frac{\rho^2}{S_0} \left( \frac{S_0}{\rho} - 1 \right) \right\} \right] + B$$

where 
$$B = \tanh^{-1} \left[ \frac{1}{A} \left( \frac{S_0}{\rho} - 1 \right) \right] = \text{constant}$$

$$\therefore R = \frac{\rho^2}{S_0} \left[ \frac{S_0}{\rho} - 1 + A \tanh \left( \frac{1}{2} A \beta t - B \right) \right] \quad (3.5.11)$$

Equation (3.5.11) gives the appropriate number of individual removed by time  $t$ .

As  $t \rightarrow \infty$  equation (3.5.11) gives

$$R_\infty = \frac{\rho^2}{S_0} \left( \frac{S_0}{\rho} - 1 + A \right),$$

if  $I_0 \approx 0$ ,  $S_0 > \rho$ , then

$$A = \frac{S_0}{\rho} - 1$$

$$\therefore R_\infty = 2\rho \left( 1 - \frac{\rho}{S_0} \right) \quad (3.5.12)$$

This gives the ultimate size of epidemic.

If  $S_0 < \rho$ , then  $\frac{dI}{dt}$  is initially negative and the epidemic does not build up. Hence the epidemic builds up only if  $\rho < S_0$ , i.e., only when the effective removal rate is less than the initial number of susceptible, and in this case, all the persons do not get infected. A stage may be reached when all the infected persons are immediately removed. Thus an epidemic builds up only when the density of susceptible is high owing to overcrowding and the rate of removal is low due to inadequate isolation facilities. On the other hand, if the isolation conditions are good and the density of susceptible is low, the epidemic

fades out.

If we put  $S_0 = \rho + \epsilon$ , where  $\epsilon$  is very small and  $I_0 \approx 0$ , then from (3.5.12), we get

$$R_\infty = 2\rho \left( 1 - \frac{\rho}{\rho + \epsilon} \right) = \frac{2\rho\epsilon}{\rho + \epsilon} = 2\epsilon \left( 1 + \frac{\epsilon}{\rho} \right)^{-1}$$

$$\therefore R_\infty = 2\epsilon \left( 1 - \frac{\epsilon}{\rho} + \frac{\epsilon^2}{\rho^2} - \dots \right)$$

$$\text{i.e.,} \quad R_\infty \approx 2\epsilon$$

This result predicts that sooner or later the number of persons infected and consequently removed will be  $2\epsilon$ , where  $\epsilon$  is the amount by which the relative removal rate  $\rho$  falls very short of its threshold value  $S_0$ .

From above discussion, we notice that the initial density of susceptible  $\rho + \epsilon$  is reduced to a final density  $\rho - \epsilon$ , i.e., the final density is as far below the threshold value  $\rho$  just as the initial density above it. This is known as the kermack-mckendrick threshold theorem.

### 3.6 Conclusion

In this chapter we have discussed some simple epidemic models. In section 3.3 we have seen that in SI model once an epidemic begins, every one in the population ultimately contract the disease. In SIS model if  $K = \alpha N - \beta < 0$ , then  $I \rightarrow 0$  as  $t \rightarrow \infty$  and if  $K = \alpha N - \beta > 0$ , then  $I \rightarrow K/\alpha$  as  $t \rightarrow \infty$ . In SIR model number of susceptible is always decreasing and the number of recovered is always increasing.

# CHAPTER FOUR

## SVIS Model

### 4.1 Introduction

In this chapter an SIS type disease has been considered when a vaccination program is in effect and there is a constant flow of incoming immigrants. Let  $S(t)$  be the number of population who are susceptible to an infection at time  $t$ ,  $I(t)$  be the number of members who are infective at time  $t$ , and  $V(t)$  be the number of members who are vaccinated at time  $t$ . Suppose the total population size at time  $t$  is  $N(t)$ , with  $N(t) = S(t) + V(t) + I(t)$  for the SIS model (the disease confers no immunity).

Assume that each infective makes  $\alpha N$  contacts sufficient to transmit infection in unit time, where  $\alpha$  is a constant. When an infective makes contact, the probability of producing a new infection is  $S/N$ , since the new infection can be made only when a contact is made with a susceptible. Thus, the rate of producing new infections is

$\alpha N \cdot \frac{S}{N} \cdot I = \alpha SI$ . Suppose susceptible population is vaccinated at a constant rate  $\phi$ ,

and the rate at which the vaccine wears off is  $\theta$ . We assume that there can be disease related deaths as well as natural deaths unrelated to the disease. The population is replenished in two ways, birth and immigration. We assume that all newborns enter the susceptible class at a constant rate,  $\Lambda$ , and that there is a constant incoming flow  $A$  of immigrants where some portion of immigrants  $p$ , is infective.

In summary, the assumptions we have in this model is as follows:

- $S(t), I(t), V(t)$  and  $N(t)$  are the numbers of susceptible, infective, vaccinated, and total population at time  $t$ , respectively.
- There is a constant flow  $A$  of new members into the population per unit time, where fraction  $p$  of immigrants is infective ( $0 \leq p \leq 1$ ).
- The vaccine has effect of reducing infection by a factor of  $\sigma$ , so that  $\sigma = 0$  means that the vaccine is completely effective in preventing infection, while  $\sigma = 1$  means that the vaccine is utterly ineffective.
- The rate at which the susceptible population is vaccinated is  $\phi$ , and the rate at which the vaccine wears off is  $\theta$ .
- The disease can be fatal to some infective and we define  $\beta$  to be the rate of disease related death.
- There is a constant per capita natural death rate  $\mu > 0$  in each class.
- Fraction  $\gamma \geq 0$  of infective recovers in unit time.
- $\alpha N$  is the infectious contact rate per person in unit time.
- $\Lambda$  is the constant natural birth rate, with all newborns coming into the susceptible class.

The following table shows the summary of notation.

**Table 4.1.1: Summary of notation for SVIS model**

Notation	Explanation
$S(t)$	Number of susceptible at time $t$
$V(t)$	Number of vaccinated individuals at time $t$
$I(t)$	Number of infective at time $t$
$A$	Number of immigrants
$p$	Portion of infective among immigrants
$\Lambda$	Birth rate
$\alpha$	Contact rate
$\gamma$	Recovery rate
$\phi$	Vaccination rate
$\sigma$	Factor by which the vaccine reduces infection
$\theta$	Rate at which the vaccine wears off
$\mu$	Natural death rate unrelated to the disease
$\beta$	Disease related death rate

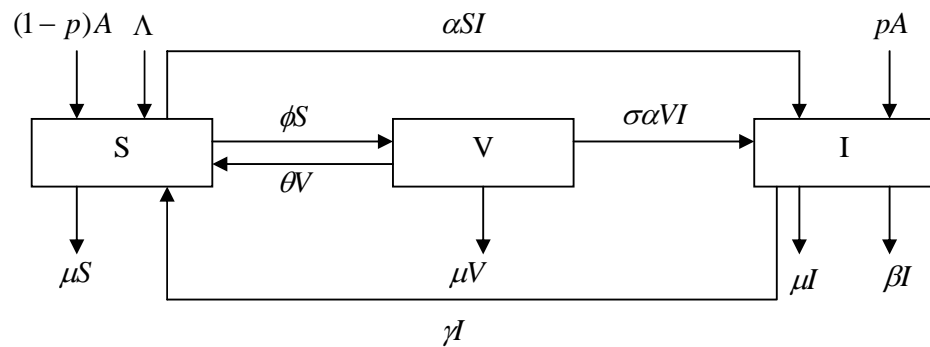

**Figure 4.1.1: Diagram of SVIS model**



The differential equations of this model are given by

$$\left. \begin{aligned} S' &= (1-p)A + \Lambda - \alpha SI - (\mu + \phi)S + \gamma I + \theta V \\ I' &= pA + \alpha SI + \sigma \alpha VI - (\mu + \gamma + \beta)I \\ V' &= \phi S - \sigma \alpha VI - (\mu + \theta)V \end{aligned} \right\} \quad (4.1.1)$$

Note that the total population is the sum of three classes: susceptible, infective, and vaccinated, i.e.,

$$N(t) = S(t) + V(t) + I(t) \quad (4.1.2)$$

So, 
$$N'(t) = S'(t) + V'(t) + I'(t)$$

Using (4.1.1) we get

$$N'(t) = A + \Lambda - \mu(S + V + I) - \beta I$$

$$\Rightarrow \quad N' = A + \Lambda - \mu N - \beta I \quad [\text{using (4.1.2)}]$$

The system of equations (4.1.1) is the SVIS model that we will use to investigate the behavior of an SIS type disease throughout this chapter. We will study first the simpler case of no disease related death.

## 4.2 A model of SVIS type without disease-related death

If the disease causes no fatality ( $\beta = 0$ ) then we can simplify the model equations (4.1.1) by letting  $\beta = 0$  as follows:

$$\left. \begin{aligned} S' &= (1-p)A + \Lambda - \alpha SI - (\mu + \phi)S + \gamma I + \theta V \\ I' &= pA + \alpha SI + \sigma \alpha VI - (\mu + \gamma)I \\ V' &= \phi S - \sigma \alpha VI - (\mu + \theta)V \end{aligned} \right\} \quad (4.2.1)$$

with

$$N' = A + \Lambda - \mu N$$

The system is clearly asymptotically autonomous, so we can define the limit value of  $N$  as

follows:

$$\lim_{t \rightarrow \infty} N'(t) = 0$$

$$\Rightarrow \lim_{t \rightarrow \infty} (A + \Lambda - \mu N(t)) = 0$$

$$\Rightarrow A + \Lambda - \mu \lim_{t \rightarrow \infty} N(t) = 0$$

$$\Rightarrow \lim_{t \rightarrow \infty} N(t) = \frac{A + \Lambda}{\mu} \equiv K, \text{ (say)}$$

**Definition 4.2.1** Consider the differential equation

$$\frac{dx}{dt} = \dot{x} = f(x) \quad (4.2.2)$$

where  $x = x(t) \in R^n$  is a vector valued function of an independent variable (usually time) and  $f:U \rightarrow R^n$  is a smooth function defined on some subset  $U \subseteq R^n$ . The

systems of the form (4.2.2), in which the vector field does not contain time explicitly, are called autonomous.

**Definition 4.2.2** The system  $y' = f(t, y)$  is called asymptotically autonomous on the set  $\Omega$  if and only if

1.  $\lim_{t \rightarrow \infty} f(t, y) = h(y)$  for  $y \in \Omega$  and this convergence is uniform for  $y$  in closed bounded subsets of  $\Omega$ .

2. For every  $\epsilon > 0$  and every  $y \in \Omega$  there exists a  $\delta(\epsilon, y) > 0$  such that

$$|f(t, y) - f(t, x)| < \epsilon, \text{ whenever } |x - y| < \delta \text{ for } 0 \leq t < \infty.$$

According to the theory of asymptotically autonomous system we can reduce it to two dimensional system by replacing  $S$  with  $K - I - V$ .

So, from the system (4.2.1) we get

$$\left. \begin{aligned} I' &= pA + \alpha[K - I - (1 - \sigma)V]I - (\mu + \gamma)I \\ V' &= \phi[K - I - V] - \sigma\alpha VI - (\mu + \theta)V \end{aligned} \right\} \quad (4.2.3)$$

This is the system that we will analyze in order to find the basic reproductive number. For an equilibrium, we can set the right hand side of equations (4.2.3) to be zero, which gives the equilibrium conditions:

$$pA + \alpha[K - I - (1 - \sigma)V]I - (\mu + \gamma)I = 0 \quad (4.2.4)$$

and

$$\phi[K - I - V] - \sigma\alpha VI - (\mu + \theta)V = 0 \quad (4.2.5)$$

From (4.2.5), we get

$$V = \frac{\phi(K - I)}{\alpha\sigma I + \theta + \mu + \phi}$$

Putting the value of V in (4.2.4) we get

$$pA + \alpha \left[ K - I - (1 - \sigma) \frac{\phi(K - I)}{\alpha\sigma I + \theta + \mu + \phi} \right] I - (\mu + \gamma)I = 0$$

After simplifying we get

$$\alpha\sigma I^3 + ((\mu + \theta + \sigma\phi) + \sigma(\mu + \gamma) - \sigma\alpha K)I^2 + \left( \frac{(\mu + \gamma)(\mu + \theta + \phi)}{\alpha} - p\sigma A - K(\mu + \theta + \sigma\phi) \right) I - \frac{pA(\mu + \theta + \phi)}{\alpha} = 0$$

$$\Rightarrow f(I) = EI^3 + BI^2 + CI + D = 0 \quad (4.2.6)$$

where

$$E = \alpha\sigma$$

$$B = (\mu + \theta + \sigma\phi) + \sigma(\mu + \gamma) - \sigma\alpha K$$

$$C = \frac{(\mu + \gamma)(\mu + \theta + \phi)}{\alpha} - p\sigma A - K(\mu + \theta + \sigma\phi)$$

$$D = -\frac{pA(\mu + \theta + \phi)}{\alpha}$$

**Proposition 4.2.1.** If the system (4.2.1) has three distinct endemic steady states then the following two conditions must be satisfied.

$$B = (\mu + \theta + \sigma\phi) + \sigma(\mu + \gamma) - \sigma\alpha K < 0$$

and

$$C = \frac{(\mu + \gamma)(\mu + \theta + \phi)}{\alpha} - p\sigma A - K(\mu + \theta + \sigma\phi) > 0$$

**Proof:** Here we consider the equation (4.2.6), i.e.,

$$f(I) = EI^3 + BI^2 + CI + D = 0$$

where

$$E = \alpha\sigma$$

$$B = (\mu + \theta + \sigma\phi) + \sigma(\mu + \gamma) - \sigma\alpha K$$

$$C = \frac{(\mu + \gamma)(\mu + \theta + \phi)}{\alpha} - p\sigma A - K(\mu + \theta + \sigma\phi)$$

$$D = -\frac{pA(\mu + \theta + \phi)}{\alpha}$$

Note that for all non negative parameters,  $E \geq 0$  and  $D \leq 0$ . If  $D \neq 0$ , then there are either one or three positive roots since  $f(0) < 0$  and  $\lim_{I \rightarrow \infty} f(I) = \infty$ . Now differentiating  $f(I)$  with respect to  $I$ , we get  $f'(I) = 3EI^2 + 2BI + C$ . If  $f(I) = 0$  has three positive roots, then from the Rolle's theorem  $f'(I) = 3EI^2 + 2BI + C = 0$  has two positive roots. This is possible if  $B^2 - 3EC > 0$ ,  $B < 0$  and  $C > 0$ . Thus  $B < 0$  and  $C > 0$  are the necessary condition for the system (4.2.1) has three distinct endemic steady states.

### 4.2.1 Equilibriums and stability analysis

Now linearize the system (4.2.3) we get the jacobean matrix

$$J = \begin{bmatrix} \frac{\partial I'}{\partial V'} & \frac{\partial I'}{\partial V} \\ \frac{\partial I}{\partial V'} & \frac{\partial I}{\partial V} \end{bmatrix}$$

i.e., 
$$J = \begin{bmatrix} -2\alpha I - (1-\sigma)\alpha V - (\mu + \gamma) + \alpha K & -\alpha(1-\sigma)\alpha I \\ -(\phi + \sigma\alpha V) & -(\mu + \theta + \phi + \sigma\alpha I) \end{bmatrix}$$

Using the equilibrium condition (4.2.4) we get

$$J = \begin{bmatrix} -\frac{pA}{I} - \alpha I & -\alpha(1-\sigma)\alpha I \\ -(\phi + \sigma\alpha V) & -(\mu + \theta + \phi + \sigma\alpha I) \end{bmatrix}$$

Now trace of this matrix is

$$tr(J) = -\frac{pA}{I} - \alpha I - (\mu + \theta + \phi + \sigma\alpha I) = -\left(\frac{pA}{I} + \alpha I + \mu + \theta + \phi + \sigma\alpha I\right)$$

Which is always negative for positive parameter.

The determinant of the matrix is

$$\begin{aligned} \det(J) &= \sigma(\alpha I)^2 + \alpha I(\mu + \theta + \phi) + \frac{pA}{I}(\mu + \theta + \phi + \sigma\alpha I) - (1-\sigma)\phi\alpha I - (1-\sigma)\sigma\alpha^2 VI \\ &= \alpha I[\sigma\alpha I + (\mu + \theta + \sigma\phi) - \sigma\alpha(K - I) + (\mu + \gamma)\sigma] + \frac{pA}{I}(\mu + \theta + \phi + \sigma\alpha I) \end{aligned}$$

Now simplify the determinant using equilibrium condition, we get

$$\begin{aligned}
 \det(J) &= \alpha[2\sigma\alpha I + (\mu + \theta + \sigma\phi) + \sigma(\mu + \gamma) - \sigma\alpha K] + \frac{pA}{I}(\mu + \theta + \phi + \sigma\alpha I) \\
 &= \alpha I(2EI + B) + \frac{pA}{I}(\mu + \theta + \phi + \sigma\alpha I) \\
 &= \alpha I(2EI + B) + \frac{\alpha}{I} \left( \frac{pA(\mu + \theta + \phi)}{\alpha} \right) \\
 &= \alpha I \left( 2EI + B - \frac{D}{I^2} \right) \\
 &= \frac{\alpha}{I} [2EI^3 + BI^2 - D] \\
 \therefore \det(J) &= \frac{\alpha}{I} [I^2(2EI + B) - D]
 \end{aligned}$$

Since  $tr(J) < 0$  for all positive parameters, then the steady states are asymptotically stable if and only if  $\det(j) > 0$

This implies, 
$$\frac{\alpha}{I} [I^2(2EI + B) - D] > 0$$

$$\Rightarrow [I^2(2EI + B) - D] > 0$$

$$\Rightarrow I^2(2EI + B) > D$$

$$\Rightarrow 2EI + B > \frac{D}{I^2}$$

$$\therefore B > \frac{D}{I^2} - 2EI$$

where

$$E = \alpha\sigma$$

$$B = (\mu + \theta + \sigma\phi) + \sigma(\mu + \gamma) - \sigma\alpha K$$

$$D = -\frac{pA(\mu + \theta + \phi)}{\alpha}$$

On the other hand for all positive parameters  $D < 0$  and  $E > 0$ . Therefore if  $B > 0$ , then  $\det(J) > 0$ . So the steady states are asymptotically stable if  $B > 0$ ,

$$\text{i.e.,} \quad (\mu + \theta + \sigma\phi) + \sigma(\mu + \gamma) - \sigma\alpha K > 0$$

**Proposition 4.2.2.** The exchange of stability occurs when the slope of bifurcation curve  $\phi$  vs  $I$ , changes.

**Proof:** Let us recall the equilibrium condition, (4.2.6). Throughout the stability analysis from above, we know that the zero value of the determinant of the Jacobean matrix of the system indicates the threshold for stability changes, therefore the threshold condition is

$$\det(J) = \frac{\alpha}{I} [2EI^3 + BI^2 - D] = 0$$

$$\Rightarrow 2EI^3 + BI^2 - D = 0 \quad (4.2.7)$$



Now differentiating (4.2.6) implicitly with respect to  $\phi$  we get

$$I^3 \frac{dE}{d\phi} + 3EI^2 \frac{dI}{d\phi} + I^2 \frac{dB}{d\phi} + 2BI \frac{dI}{d\phi} + I \frac{dC}{d\phi} + C \frac{dI}{d\phi} = 0$$

$$\Rightarrow (3EI^2 + 2BI + C) \frac{dI}{d\phi} = - \left[ I^3 \frac{dE}{d\phi} + I^2 \frac{dB}{d\phi} + I \frac{dC}{d\phi} \right]$$

$$\Rightarrow \frac{dI}{d\phi} = - \frac{I^3 \frac{dE}{d\phi} + I^2 \frac{dB}{d\phi} + I \frac{dC}{d\phi}}{3EI^2 + 2BI + C}$$

When the sign of the slope of the bifurcation curve changes, one can find a threshold point by letting

$$\frac{dI}{d\phi} = \infty$$

$$\text{i.e.,} \quad 3EI^2 + 2BI + C = 0$$

$$\text{i.e.,} \quad 3EI^3 + 2BI^2 + CI = 0 \quad (4.2.8)$$

Now, we shall show that these two conditions (4.2.7) and (4.2.8) are equivalent by using the equilibrium condition

$$f(I) = EI^3 + BI^2 + CI + D = 0$$

$$\text{Now,} \quad (3EI^3 + 2BI^2 + CI) - (2EI^3 + BI^2 - D) = EI^3 + BI^2 + CI + D = f(I) = 0$$

$$3EI^3 + 2BI^2 + CI = 2EI^3 + BI^2 - D$$

Therefore the two conditions (4.2.7) and (4.2.8) are equivalent. In summary, using the equilibrium condition  $f(I) = EI^3 + BI^2 + CI + D = 0$ , one can show that when the sign of the slope of the bifurcation curve changes, its stability changes too. The following figure 4.2.1 is the bifurcation curve  $\phi$  vs  $I$  (here  $\alpha = 0.7$ ,  $\gamma = 12$ ,  $\sigma = 0.2$ ,  $\mu = 0.1$ ,  $\theta = 0.5$ ,  $p = 0.2$ , and  $A = 2$ )

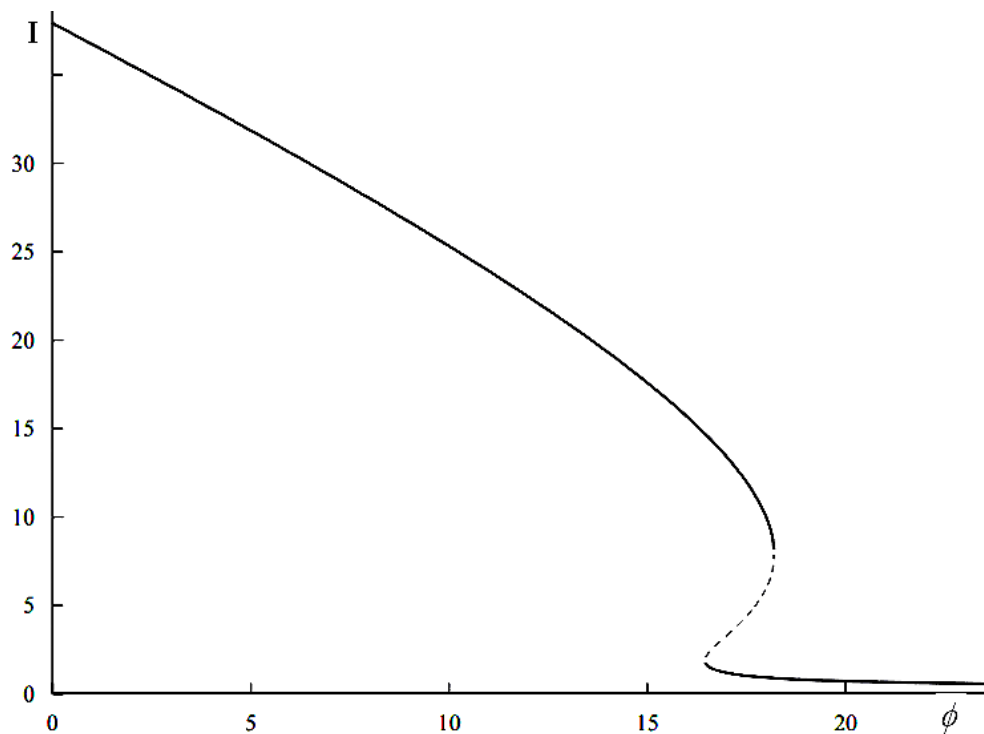

Figure 4.2.1: Bifurcation curve  $\phi$  vs  $I$

### 4.3 A model of SVIS type with disease-related death

In this case  $\beta \neq 0$ . We now consider the original model which includes non-zero disease fatality. Recalling the original system of differential equation, let us remind the system of differential equations, (4.1.1):

$$\begin{aligned}
S' &= (1-p)A + \Lambda - \alpha SI - (\mu + \phi)S + \gamma I + \theta V \\
I' &= pA + \alpha SI + \sigma \alpha VI - (\mu + \gamma + \beta)I \\
V' &= \phi S - \sigma \alpha VI - (\mu + \theta)V
\end{aligned}$$

Here the total population is the sum of three classes, susceptible, infective and vaccinated, i.e.

$$N(t) = S(t) + V(t) + I(t)$$

Thus it follows that

$$N' = S' + V' + I' = A + \Lambda - \mu(S + V + I) - \beta I$$

$$\Rightarrow N' = A + \Lambda - \mu N - \beta I$$

We can get an alternate but yet equivalent model by replacing  $S$  with  $N - V - I$ . Now the model becomes:

$$\begin{aligned}
I' &= pA + \alpha(N - V - I)I + \sigma \alpha VI - (\mu + \gamma + \beta)I \\
V' &= \phi(N - V - I) - \sigma \alpha VI - (\mu + \theta)V \\
N' &= A + \Lambda - \mu N - \beta I
\end{aligned}$$

$$\Rightarrow \left. \begin{aligned}
I' &= pA + \alpha I [N - I - (1 - \sigma)V] - (\mu + \gamma + \beta)I \\
V' &= \phi(N - I) - \sigma \alpha VI - (\mu + \theta + \phi)V \\
N' &= A + \Lambda - \mu N - \beta I
\end{aligned} \right\} \quad (4.3.1)$$

We can write the equilibrium conditions by letting the right hand side equations of (4.3.1) to be zero. The equilibrium conditions are

$$pA + \alpha I [N - I - (1 - \sigma)V] - (\mu + \gamma + \beta)I = 0 \quad (4.3.2)$$

$$\phi(N - I) - \sigma\alpha VI - (\mu + \theta + \phi)V = 0 \quad (4.3.3)$$

$$A + \Lambda - \mu N - \beta I = 0 \quad (4.3.4)$$

From (4.3.4) we get

$$N = \frac{A + \Lambda - \beta I}{\mu}$$

Again from (4.3.3) we get

$$V = \frac{\phi(N - I)}{\sigma\alpha I + \mu + \theta + \phi}$$

$$\Rightarrow V = \frac{\phi[A + \Lambda - (\beta + \mu)I]}{\mu(\sigma\alpha I + \mu + \theta + \phi)} \quad \therefore N = \frac{A + \Lambda - \beta I}{\mu}$$

Eliminating  $N$  and  $V$  by substitution of these expressions into the equation (4.3.2), we get the equilibrium condition of the form

$$pA + \alpha I \left[ \frac{A + \Lambda - \beta I}{\mu} - I - (1 - \sigma) \frac{\phi[A + \Lambda - (\beta + \mu)I]}{\mu(\sigma\alpha I + \mu + \theta + \phi)} \right] - (\mu + \gamma + \beta)I = 0$$

Now simplifying by wxMaxima, we obtain an expression involving  $I$  of the form

$$EI^3 + BI^2 + CI + D = 0,$$

where

$$E = \alpha\sigma(\beta + \mu)$$

$$B = -(A + \Lambda)\sigma\alpha + (\beta + \mu)(\mu + \theta + \sigma\phi) + \sigma\mu(\mu + \gamma + \beta)$$

$$C = -\mu p \sigma A - (A + \Lambda)(\mu + \theta + \sigma \phi) + \frac{\mu(\mu + \gamma + \beta)(\mu + \theta + \phi)}{\alpha}$$

$$D = -\frac{\mu p A(\mu + \theta + \phi)}{\alpha}$$

### 4.3.1 Equilibriums and stability analysis

In order to study the stability of steady states we start a qualitative approach by linearization of (4.3.1). Now the jacobian matrix of the system (4.3.1) is

$$J = \begin{bmatrix} \frac{\partial I'}{\partial V'} & \frac{\partial I'}{\partial V} & \frac{\partial I'}{\partial N'} \\ \frac{\partial I}{\partial V'} & \frac{\partial I}{\partial V} & \frac{\partial I}{\partial N'} \\ \frac{\partial N'}{\partial V'} & \frac{\partial N'}{\partial V} & \frac{\partial N'}{\partial N'} \end{bmatrix}$$

$$\Rightarrow J = \begin{bmatrix} \alpha[N - (1 - \sigma)V - I] - \alpha I - (\mu + \gamma + \beta) & -\alpha(1 - \sigma)I & \alpha I \\ -(\phi + \sigma \alpha V) & -\sigma \alpha I - (\mu + \theta + \phi) & \phi \\ -\beta & 0 & -\mu \end{bmatrix}$$

Using the equation (4.3.2), we can rewrite the jacobian matrix as

$$J = \begin{bmatrix} -\frac{pA}{I} - \alpha I & -\alpha(1 - \sigma)I & \alpha I \\ -(\phi + \sigma \alpha V) & -\sigma \alpha I - (\mu + \theta + \phi) & \phi \\ -\beta & 0 & -\mu \end{bmatrix}$$

After a complicated computation (with wxMxima), we can obtain its characteristic equation as:

$$\lambda^3 + a_1 \lambda^2 + a_2 \lambda + a_3 = 0,$$

where

$$a_1 = (1 + \sigma)\alpha I + \frac{pA}{I} + 2\mu + \theta + \phi$$

$$a_2 = \left( \alpha I + \frac{pA}{I} + \mu \right) (\mu + \theta + \varphi + \sigma\alpha I) + \mu \left( \alpha I + \frac{pA}{I} \right) + \alpha\beta I - \alpha I (1 - \sigma) (\phi + \sigma\alpha V)$$

$$a_3 = \mu \left( \alpha I + \frac{pA}{I} \right) (\mu + \theta + \varphi + \sigma\alpha I) - \mu\alpha I (1 - \sigma) (\phi + \sigma\alpha V) + \alpha\beta I (\mu + \theta + \sigma\varphi + \sigma\alpha I)$$

By the Routh-Hurwitz Criterion, the steady state is globally stable if and only iff

$$a_1 > 0, a_3 > 0 \text{ and } a_1 a_2 > a_3$$

The Figure 4.3.1 is the bifurcation curve  $\phi$  vs  $I$  (here  $\alpha = 0.9$ ,  $\beta = 0.7$ ,  $\gamma = 12$ ,  $\sigma = 0.2$ ,  $\mu = 0.1$ ,  $\theta = 0.5$ ,  $p = 0.4$ ,  $\Lambda = 3$  and  $A = 2$ ) which demonstrates a case where an equilibrium graph loses its stability as the vaccination rate  $\phi$ , increases and becomes stable again. At the point where it loses local stability first, Hopf-bifurcation occurs and a periodic solution appears for some values of  $\phi$ .

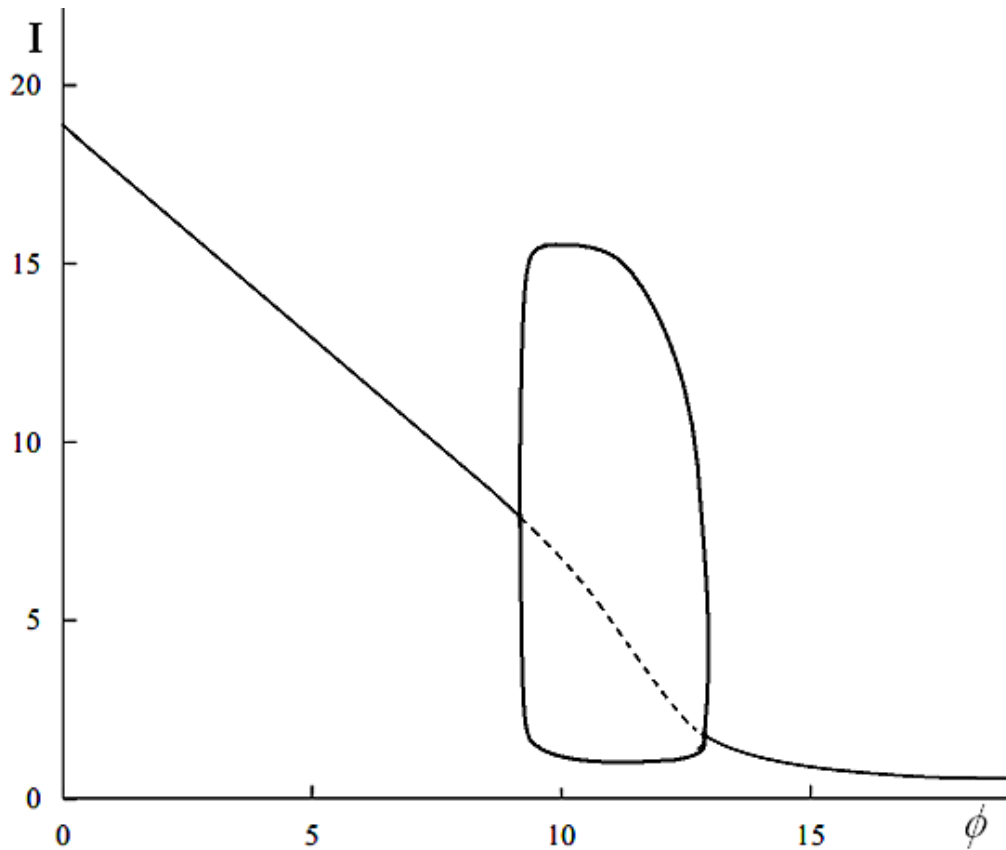

**Figure 4.3.1: Bifurcation curve  $\phi$  vs  $I$  with disease-related death**

### 4.3.2 The case where there are no infective immigrants

It is worthwhile to consider the case without infective immigrants since in this case the system will have a disease-free steady state that would not exist otherwise. This model was proposed by Kribs-Zaleta and Vekasco-Hernandezin. If there is no infective portion from immigrants, i.e.  $p = 0$ , then our equation becomes

$$\begin{aligned} S' &= A + \Lambda - \alpha SI - (\mu + \phi)S + \gamma I + \theta V \\ I' &= \alpha SI + \sigma \alpha VI - (\mu + \gamma + \beta)I \\ V' &= \phi S - \sigma \alpha VI - (\mu + \theta)V \end{aligned}$$

Recall that the total population is the sum of three classes, susceptible, infective and vaccinated, i.e.

$$N(t) = S(t) + V(t) + I(t)$$

Thus it follows that

$$N' = S' + V' + I' = A + \Lambda - \mu(S + V + I) - \beta I$$

$$\Rightarrow N' = A + \Lambda - \mu N - \beta I$$

As before we can make a similar transformation by replacing  $S$  with  $N - V - I$ . Now the model becomes:

$$\begin{aligned} I' &= \alpha(N - V - I)I + \sigma\alpha VI - (\mu + \gamma + \beta)I \\ V' &= \phi(N - V - I) - \sigma\alpha VI - (\mu + \theta)V \\ N' &= A + \Lambda - \mu N - \beta I \end{aligned}$$

$$\Rightarrow \left. \begin{aligned} I' &= \alpha I [N - I - (1 - \sigma)V] - (\mu + \gamma + \beta)I \\ V' &= \phi(N - I) - \sigma\alpha VI - (\mu + \theta + \phi)V \\ N' &= A + \Lambda - \mu N - \beta I \end{aligned} \right\} \quad (4.3.5)$$

We can write the equilibrium conditions by letting the right hand side equations of (4.3.5) to be zero. The equilibrium conditions are

$$\alpha I [N - I - (1 - \sigma)V] - (\mu + \gamma + \beta)I = 0 \quad (4.3.6)$$

$$\phi(N - I) - \sigma\alpha VI - (\mu + \theta + \phi)V = 0 \quad (4.3.7)$$

$$A + \Lambda - \mu N - \beta I = 0 \quad (4.3.8)$$



From (4.3.4) we get

$$N = \frac{A + \Lambda - \beta I}{\mu}$$

Again from (4.3.3) we get

$$V = \frac{\phi(N - I)}{\sigma\alpha I + \mu + \theta + \phi}$$

$$\Rightarrow V = \frac{\phi[A + \Lambda - (\beta + \mu)I]}{\mu(\sigma\alpha I + \mu + \theta + \phi)} \quad \because N = \frac{A + \Lambda - \beta I}{\mu}$$

Eliminating  $N$  and  $V$  by substitution of these expressions into the equation (4.3.2), we get the equilibrium condition of the form

$$\alpha I \left[ \frac{A + \Lambda - \beta I}{\mu} - I - (1 - \sigma) \frac{\phi[A + \Lambda - (\beta + \mu)I]}{\mu(\sigma\alpha I + \mu + \theta + \phi)} \right] - (\mu + \gamma + \beta)I = 0$$

We can further simplify by multiplying  $\mu(\sigma\alpha I + \mu + \theta + \phi)$  and factoring out a disease free Equilibrium

$$I^* = 0$$

In order to obtain an endemic condition as the quadratic equation for the equilibrium values of  $I$  of the form

$$EI^2 + BI + C = 0,$$

where

$$E = \alpha\sigma(\beta + \mu)$$

$$B = -(A + \Lambda)\sigma\alpha + (\beta + \mu)(\mu + \theta + \sigma\phi) + \sigma\mu(\mu + \gamma + \beta)$$

$$C = -(A + \Lambda)(\mu + \theta + \sigma\phi) + \frac{\mu(\mu + \gamma + \beta)(\mu + \theta + \phi)}{\alpha}$$

In order to study the stability of steady states we linearize (4.3.5), obtaining the jacobian matrix.

$$J = \begin{bmatrix} \alpha[N - (1 - \sigma)V - I] - \alpha I - (\mu + \gamma + \beta) & -\alpha(1 - \sigma)I & \alpha I \\ -(\phi + \sigma\alpha V) & -\sigma\alpha I - (\mu + \theta + \phi) & \phi \\ -\beta & 0 & -\mu \end{bmatrix}$$

At the disease free equilibrium  $I^* = 0$ , The Jacobean becomes

$$J_0 = \begin{bmatrix} \alpha[N - (1 - \sigma)V] - (\mu + \gamma + \beta) & 0 & \alpha I \\ -(\phi + \sigma\alpha V) & -(\mu + \theta + \phi) & \phi \\ -\beta & 0 & -\mu \end{bmatrix}$$

Now we obtain three real eigenvalues of  $J_0$  as

$$\lambda_1 = -\mu$$

$$\lambda_2 = -(\mu + \theta + \phi)$$

$$\lambda_3 = \alpha[N - (1 - \sigma)V] - (\mu + \gamma + \beta)$$

$$= \frac{\alpha(\mu + \theta + \sigma\phi)(A + \Lambda)}{\mu(\mu + \theta + \phi)} - (\beta + \mu + \gamma)$$

For positive parameters, it is clear that  $\lambda_1 < 0$  and  $\lambda_2 < 0$ . So the disease free equilibrium is asymptotically stable iff  $\lambda_3 < 0$ .

$$\Rightarrow \frac{\alpha(\mu + \theta + \sigma\phi)(A + \Lambda)}{\mu(\mu + \theta + \phi)} - (\beta + \mu + \gamma) < 0$$

$$\Rightarrow \frac{\alpha(\mu + \theta + \sigma\phi)(A + \Lambda)}{\mu(\mu + \theta + \phi)} < (\beta + \mu + \gamma)$$

$$\Rightarrow \frac{\alpha(\mu + \theta + \sigma\phi)(A + \Lambda)}{\mu(\mu + \theta + \phi)(\beta + \mu + \gamma)} < 1$$

Now we can define the vaccine reproduction number  $R(\phi) = \frac{\alpha(\mu + \theta + \sigma\phi)(A + \Lambda)}{\mu(\mu + \theta + \phi)(\beta + \mu + \gamma)}$ .

Also by using the endemic equilibrium condition, (4.3.6) we can evaluate the Jacobean matrix at endemic equilibriums.

Using the equation (4.3.2), we can rewrite the jacobean matrix as

$$J = \begin{bmatrix} -\alpha I & -\alpha(1-\sigma)I & \alpha I \\ -(\phi + \sigma\alpha V) & -\sigma\alpha I - (\mu + \theta + \phi) & \phi \\ -\beta & 0 & -\mu \end{bmatrix}$$

with the characteristic equation:

$$\lambda^3 + a_1\lambda^2 + a_2\lambda + a_3 = 0,$$

where

$$a_1 = (1 + \sigma)\alpha I + 2\mu + \theta + \phi$$

$$a_2 = (\alpha I + \mu)(\mu + \theta + \varphi + \sigma\alpha I) + \alpha(\mu + \beta)I - \alpha I(1 - \sigma)(\phi + \sigma\alpha V)$$

$$a_3 = \mu\alpha I(\mu + \theta + \sigma\phi + \sigma\alpha I + \sigma\alpha(\sigma - 1)V) + \alpha\beta I(\mu + \theta + \sigma\varphi + \sigma\alpha I)$$

By the Routh-Hurwitz Criterion, the endemic steady state is stable iff  $a_1 > 0$ ,  $a_3 > 0$  and  $a_1 a_2 > a_3$ .

For this model there is a transcritical bifurcation at

$$\phi = \frac{(\mu + \theta)[\mu(\beta + \mu + \gamma) - \alpha(A + \Lambda)]}{\sigma\alpha(A + \Lambda) - \mu(\beta + \mu + \gamma)}$$

(This is obtained by solving  $R(\phi) = 1$  for  $\phi$ ) and this is demonstrated in Figure 4.3.2 (here  $\alpha = 0.9$ ,  $\beta = 0.15$ ,  $\gamma = 12$ ,  $\sigma = 0.2$ ,  $\mu = 0.1$ ,  $\theta = 0.5$ ,  $p = 0$ ,  $\Lambda = 3$  and  $A = 2$ ).

One can easily see that the lower branch of the bifurcation curve is negative for

$$\phi < \frac{(\mu + \theta)[\mu(\beta + \mu + \gamma) - \alpha(A + \Lambda)]}{\sigma\alpha(A + \Lambda) - \mu(\beta + \mu + \gamma)},$$

and coincides with the disease free equilibrium

$$\text{at } \phi = \frac{(\mu + \theta)[\mu(\beta + \mu + \gamma) - \alpha(A + \Lambda)]}{\sigma\alpha(A + \Lambda) - \mu(\beta + \mu + \gamma)}.$$

Also the disease free equilibrium is locally

$$\text{stable for } \phi > \frac{(\mu + \theta)[\mu(\beta + \mu + \gamma) - \alpha(A + \Lambda)]}{\sigma\alpha(A + \Lambda) - \mu(\beta + \mu + \gamma)}$$

and locally unstable otherwise while

the lower endemic equilibrium becomes locally unstable for

$$\phi > \frac{(\mu + \theta)[\mu(\beta + \mu + \gamma) - \alpha(A + \Lambda)]}{\sigma\alpha(A + \Lambda) - \mu(\beta + \mu + \gamma)}.$$

In summary these equilibria exchange

stability as the endemic equilibrium moves through the diseasefree equilibrium at

$\phi = \frac{(\mu + \theta)[\mu(\beta + \mu + \gamma) - \alpha(A + \Lambda)]}{\sigma\alpha(A + \Lambda) - \mu(\beta + \mu + \gamma)}$  and there exists only one epidemiologically

feasible endemic equilibrium for  $\phi < \frac{(\mu + \theta)[\mu(\beta + \mu + \gamma) - \alpha(A + \Lambda)]}{\sigma\alpha(A + \Lambda) - \mu(\beta + \mu + \gamma)}$ .

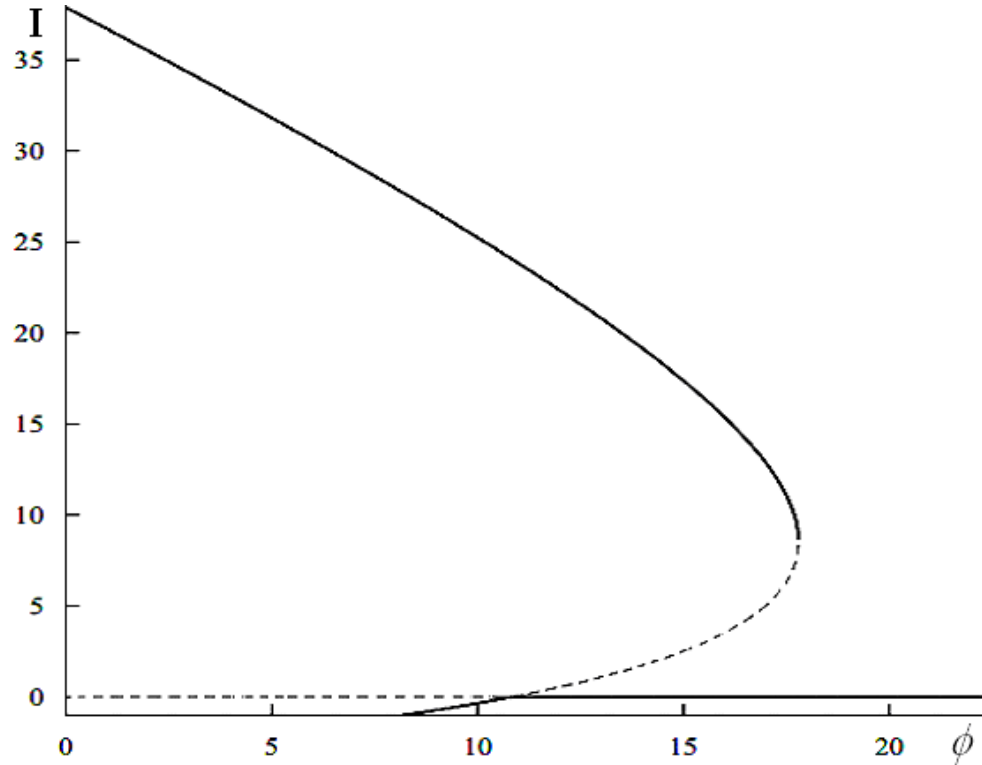

Figure 4.3.2 : Bifurcation curve  $\phi$  vs  $I$  with no infective immigrants

#### 4.4 Conclusion

The purpose of this chapter is to take a close look at the endemic behavior of the diseases of SIS type model. To a simple SIS model with vaccination we added the immigration of infective and the disease-related death. As to the contact between infective and susceptible we assume a bilinear incidence. The result of mathematical analysis indicates that a vaccination campaign  $\phi$  has an effect of reducing a

reproductive number, which means that the average number of secondary infection caused by an average infective becomes smaller when vaccination is in effect. Furthermore, in SVIS model, a vaccination campaign meant to reduce a disease's reproductive number below one, may fail to control the disease when there is a backward bifurcation. Bringing down the vaccination reproductive number just below one may not be good enough to eradicate the disease in such a case. Also if there is no immigration of infective, a typical transcritical bifurcation may be observed. The disease-free equilibrium and endemic one coincide at  $R(\phi) = 1$  and they exchange the stability at that point.

# CHAPTER FIVE

## SVI Model

### 5.1 Introduction

The spread of communicable diseases is often described mathematically by compartmental models. In 1927, Kermack and McKendrick proposed, as a particular case of a more general model presented in their seminal work. There are two major types of control strategies available to curtail the spread of infectious diseases: pharmaceutical interventions (drugs, vaccines etc) and non-pharmaceutical interventions (social distancing, quarantine). Vaccination, when it is available, is an effective preventive strategy. Arino et al introduced vaccination of susceptible individuals into an SIRS model and also considered vaccinating a fraction of newborns. Buonomo et al studied the traditional SIR model with 100% efficacious vaccine. Effective vaccines have been used successfully to control smallpox, polio and measles.

In this chapter we consider an SI type disease when a vaccination program is in effect and there is a constant flow of incoming immigrants or newborns. Let  $S(t)$  be the number of population who are susceptible to an infection at time  $t$ ,  $I(t)$  be the number of members who are infective at time  $t$ , and  $V(t)$  be the number of members who are vaccinated at time  $t$ . The total population size at time  $t$  is denoted by  $N(t)$ , with  $N(t) = S(t) + V(t) + I(t)$ . Assume that each infective makes  $\alpha N$  contacts sufficient to transmit infection in unit time, where  $\alpha$  is a constant. When an infective makes contact, the probability of producing a new infection is  $S/N$ , since the new

infection can be made only when a contact is made with a susceptible individuals.

Thus, the rate of producing new infections is  $\alpha N \cdot \frac{S}{N} \cdot I = \alpha SI$ . The susceptible

population is vaccinated at a constant rate  $\phi$ . We assume that there is no disease

related death but natural death, that is, unrelated to the disease is present. The

population is replenished in two ways, birth and immigration. We assume that all

newborns and immigrants enter the susceptible class at a constant rate  $\Lambda$ . In summary,

the assumptions we have in this model is as follows:

- $S(t), I(t), V(t)$  and  $N(t)$  are the numbers of susceptible, infective, vaccinated, and total population at time  $t$ , respectively.
- There is a constant flow  $\Lambda$  of new members into the susceptible population per unit time.
- The vaccine has effect of reducing infection by a factor of  $\sigma$ , so that  $\sigma = 0$  means that the vaccine is completely effective in preventing infection, while  $\sigma = 1$  means that the vaccine is utterly ineffective.
- The rate at which the susceptible population is vaccinated is  $\phi$ .
- There is a constant per capita natural death rate  $\mu$  in each class.
- $\alpha N$  is the infectious contact rate per person in unit time.



The following table shows the summary of notation.

**Table 5.1.1 : Summary of notation for SVI model**

Notation	Explanation
$S(t)$	Number of susceptible at time t
$V(t)$	Number of vaccinated individuals at time t
$I(t)$	Number of infective at time t
$N(t)$	Total number of population at time t
$\Lambda$	Birth rate
$\alpha$	Contact rate
$\phi$	Vaccination rate
$\sigma$	Factor by which the vaccine reduces infection
$\mu$	Natural death rate unrelated to the disease

## 5.2 Model formulation

In our model, we have divided the population into three compartments (susceptible, vaccinated susceptible and infectious) depending on the epidemiological status of individuals. We denote the population of those who are susceptible as  $S$ , who are vaccinated susceptible as  $V$  and those who subsequently infected as  $I$ . The model transfer diagram indicating the possible transitions between these compartments is shown in Figure 5.2.1.

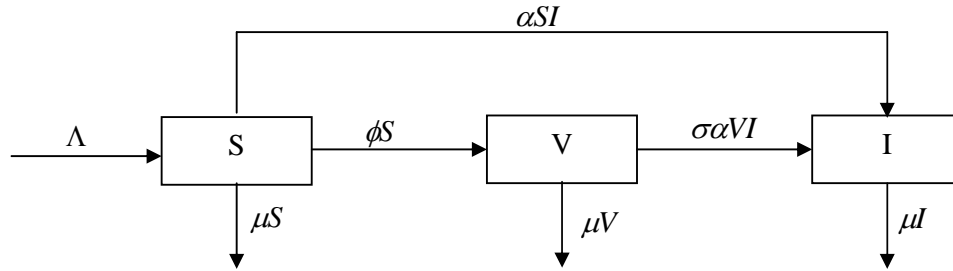

**Figure 5.2.1: Diagram of SVI model**

Populations enter the susceptible class at constant rate  $\Lambda$ . Natural death rates are assumed to be  $\mu$ . The population is assumed to undergo homogeneous mixing. We assume that each infective individual contacts an average number  $\alpha$  with other individuals per unit time. Hence, the total number of contacts by infective per unit time is  $\alpha I$ . Susceptible individuals are vaccinated at the rate  $\phi$ . Since the vaccine only provides partial protection to the infection, vaccinated individuals may still become infected but at the lower infection rate  $\sigma\alpha$  than fully susceptible individuals. Here  $1 - \sigma \in [0,1]$  describes vaccine efficacy. when  $\sigma = 0$ , the vaccine is perfectly effective and when  $\sigma = 1$ , the vaccine has no effect at all on the immunity of vaccinated individuals.

The differential equations of the model are given by:

$$\left. \begin{aligned} \frac{dS}{dt} &= \Lambda - \alpha SI - \phi S - \mu S \\ \frac{dV}{dt} &= \phi S - \mu V - \sigma \alpha VI \\ \frac{dI}{dt} &= \sigma \alpha VI + \alpha SI - \mu I \end{aligned} \right\} \quad (5.2.1)$$

### 5.3 Equilibrium conditions

We can write the equilibrium conditions by letting the right hand side of equations of (5.2.1) to be zero. Thus the equilibrium conditions are

$$\Lambda - \alpha SI - \phi S - \mu S = 0 \quad (5.3.1)$$

$$\phi S - \mu V - \sigma \alpha VI = 0 \quad (5.3.2)$$

$$\sigma \alpha VI + \alpha SI - \mu I = 0 \quad (5.3.3)$$

From (5.3.1) we get

$$S = \frac{\Lambda}{\alpha I + \mu + \phi} \quad (5.3.4)$$

Again from (5.3.2) we get

$$V = \frac{\phi S}{\sigma \alpha I + \mu} \quad (5.3.5)$$

$$\Rightarrow V = \frac{\phi \Lambda}{(\sigma \alpha I + \mu)(\alpha I + \mu + \phi)} \quad \left[ \because S = \frac{\Lambda}{\alpha I + \mu + \phi} \right]$$

Now from (5.3.3) factoring out the disease free equilibrium (DFE), we get

$$I = 0$$

Then from (5.2.4) and (5.2.5), we get

$$S = \frac{\Lambda}{\mu + \phi}$$

and

$$V = \frac{\phi \Lambda}{\mu(\mu + \phi)}$$

Therefore the disease free equilibrium is

$$P_0 = \left( \frac{\Lambda}{\mu + \phi}, \frac{\phi\Lambda}{\mu(\mu + \phi)}, 0 \right)$$

In order to study the stability of steady states we linearize (5.2.1), obtaining the Jacobean matrix.

$$J = \begin{bmatrix} \frac{\partial}{\partial S} \left( \frac{dS}{dt} \right) & \frac{\partial}{\partial V} \left( \frac{dS}{dt} \right) & \frac{\partial}{\partial I} \left( \frac{dS}{dt} \right) \\ \frac{\partial}{\partial S} \left( \frac{dV}{dt} \right) & \frac{\partial}{\partial V} \left( \frac{dV}{dt} \right) & \frac{\partial}{\partial I} \left( \frac{dV}{dt} \right) \\ \frac{\partial}{\partial S} \left( \frac{dI}{dt} \right) & \frac{\partial}{\partial V} \left( \frac{dI}{dt} \right) & \frac{\partial}{\partial I} \left( \frac{dI}{dt} \right) \end{bmatrix}$$

$$J = \begin{bmatrix} -\alpha I - \phi - \mu & 0 & -\alpha S \\ \phi & -\mu - \alpha \sigma I & -\sigma \alpha V \\ \alpha I & \sigma \alpha I & \sigma \alpha V + \alpha S - \mu \end{bmatrix}$$

#### 5.4 Stability at DFE

The jacobean matrix at the DFE  $P_0 = \left( \frac{\Lambda}{\mu + \phi}, \frac{\phi\Lambda}{\mu(\mu + \phi)}, 0 \right)$  is

$$J_0 = \begin{bmatrix} -\phi - \mu & 0 & -\frac{\alpha\Lambda}{\mu + \phi} \\ \phi & -\mu & -\frac{\sigma\alpha\phi\Lambda}{\mu(\mu + \phi)} \\ 0 & 0 & \frac{\alpha\Lambda}{\mu + \phi} + \frac{\sigma\alpha\phi\Lambda}{\mu(\mu + \phi)} - \mu \end{bmatrix}$$

$J_0$  has three real eigenvalues as follows

$$\lambda_1 = -(\phi + \mu)$$

$$\lambda_2 = -\mu$$

and

$$\lambda_3 = \frac{\alpha\Lambda}{\mu + \phi} + \frac{\sigma\alpha\phi\Lambda}{\mu(\mu + \phi)} - \mu$$

Since all parameters are positive then clearly  $\lambda_1 < 0$  and  $\lambda_2 < 0$ , So the DFE is locally stable if and only if  $\lambda_3 < 0$ .

**Definition 5.4.1 (Basic reproductive number):** The basic reproductive number,  $R_0$ , is the expected number of secondary infections arising from a single individual during his or her entire infectious period, in the population of susceptible.

**Lemma 5.4.1 :** The disease free equilibrium  $p_0$  is locally stable if and only if  $R_0 < 1$  where  $R_0$  is the basic reproductive number .

Since the above linear system (5.2.1) is locally stable if and only if  $\lambda_3 < 0$ , i.e.,

$$\frac{\alpha\Lambda}{\mu + \phi} + \frac{\sigma\alpha\phi\Lambda}{\mu(\mu + \phi)} < \mu, \text{ i.e., } \frac{\alpha\Lambda}{\mu(\mu + \phi)} + \frac{\sigma\alpha\phi\Lambda}{\mu^2(\mu + \phi)} < 1. \text{ So by the above lemma the}$$

$$\text{basic reproduction number } R_0 = \frac{\alpha\Lambda}{\mu(\mu + \phi)} + \frac{\sigma\alpha\phi\Lambda}{\mu^2(\mu + \phi)}$$

### 5.4.1 Controlling the epidemic

Since for  $R_0 = \frac{\alpha\Lambda}{\mu(\mu + \phi)} + \frac{\sigma\alpha\phi\Lambda}{\mu^2(\mu + \phi)} < 1$ , there is no epidemic; we can take various

steps to control the epidemic.

**Step 1:**

Suppose  $R_0$  is a function of  $\sigma$ . i.e,  $R_0 = R_0(\sigma) = \frac{\alpha\Lambda}{\mu(\mu+\phi)} + \frac{\sigma\alpha\phi\Lambda}{\mu^2(\mu+\phi)} = M_1\sigma + D_1$

where  $M_1 = \frac{\alpha\phi\Lambda}{\mu^2(\mu+\phi)} > 0$  and  $D_1 = \frac{\alpha\Lambda}{\mu(\mu+\phi)}$ . Therefore  $R_0$  is a linear function of

$\sigma$ . Since  $M_1 > 0$  (for positive parameters), So there exists a bifurcation value

$\sigma_0 = \frac{\mu^3 + \mu^2\phi - \alpha\mu\Lambda}{\phi\alpha\Lambda}$  of  $\sigma$  such that if  $\sigma < \sigma_0$ , then  $R_0 < 1$  and if  $\sigma > \sigma_0$ , then

$R_0 > 1$ , i.e., if  $\sigma < \sigma_0$ , then the DFE  $P_0$  is locally stable otherwise unstable

(provided  $D_1 < 1$ ). So if all parameters except  $\sigma$  are constant, then we can control the

epidemic by decreasing the value of  $\sigma$  (increasing the vaccine efficiency) so that

$\sigma < \sigma_0$ .

**Step 2:**

Suppose  $R_0$  is a function of  $\alpha$ . i.e,  $R_0 = R_0(\alpha) = \frac{\alpha\Lambda}{\mu(\mu+\phi)} + \frac{\sigma\alpha\phi\Lambda}{\mu^2(\mu+\phi)} = M_2\alpha$

where  $M_2 = \frac{\Lambda}{\mu(\mu+\phi)} + \frac{\sigma\phi\Lambda}{\mu^2(\mu+\phi)} > 0$ . Therefore  $R_0$  is a linear function of  $\alpha$ . Since

$M_2 > 0$  (for positive parameters), So there exists a bifurcation value  $\alpha_0 = \frac{\mu^2(\mu+\phi)}{\mu\Lambda + \sigma\phi\Lambda}$

of  $\alpha$  such that if  $\alpha < \alpha_0$ , then  $R_0 < 1$  and if  $\alpha > \alpha_0$ , then  $R_0 > 1$ , i.e., if  $\alpha < \alpha_0$ , then

the DFE  $P_0$  is locally stable otherwise unstable. Therefore if all parameters except  $\alpha$

are constant, then we can control the epidemic by decreasing the value of  $\alpha$

(decreasing the contact rate with infected individual) so that  $\alpha < \alpha_0$ .

**Step 3:**

Similarly (as step 2) We can reduce the value of  $R_0$  by decreasing the value of  $\Lambda$  and

we get a bifurcation value  $\Lambda_0 = \frac{\mu^2(\mu + \phi)}{\alpha\mu + \alpha\phi\sigma}$  of  $\Lambda$  such that if  $\Lambda < \Lambda_0$ , then  $R_0 < 1$  and

if  $\Lambda > \Lambda_0$ , then  $R_0 > 1$ , i.e., if  $\Lambda < \Lambda_0$ , then the DFE  $P_0$  is locally stable otherwise

unstable. Therefore if all parameters except  $\Lambda$  are constant, then we can control the epidemic by decreasing the value of  $\Lambda$  so that  $\Lambda < \Lambda_0$ .

**Step 4:**

Suppose  $R_0$  is a function of  $\phi$ . i.e.,  $R_0 = R_0(\phi) = \frac{\alpha\Lambda}{\mu(\mu + \phi)} + \frac{\phi\alpha\sigma\Lambda}{\mu^2(\mu + \phi)}$ . So for

positive parameters  $\frac{dR_0}{d\phi} = \frac{\alpha(\sigma - 1)\Lambda}{\mu^3 + 2\phi\mu^2 + \phi^2\mu} < 0$ . ( since  $\sigma < 1$ ) i.e.,  $R_0(\phi)$  is

decreasing. We can reduce the value of  $R_0$  by increasing the value of  $\phi$ . Therefore

$\phi_0 = \frac{\mu^3 - \alpha\mu\Lambda}{\alpha\sigma\Lambda - \mu^2}$  is a bifurcation value of  $\phi$  such that if  $\phi > \phi_0$ , then  $R_0 < 1$  and if

$\phi < \phi_0$ , then  $R_0 > 1$ , i.e., if  $\phi > \phi_0$ , then the DFE  $P_0$  is locally stable otherwise

unstable. Therefore we can control the epidemic by increasing the value of  $\phi$  so that

$\phi > \phi_0$ .

**5.4.2 Numerical simulation**

In order to illustrate the various theoretical results, numerical experiments (using Matlab) were carried out to compute the solutions of linear system corresponding to

(5.2.1) using the parameter values as follows:

For step 1:

**Table 5.4.1: Results for step-1.**

	Example-1	Example-3
$\phi$ (constant)	0.8	0.8
$\alpha$ (constant)	0.006	0.006
$\Lambda$ (constant)	0.008	0.008
$\sigma$	0.1	0.3
$\mu$ (constant)	0.003	0.003
$\sigma_0$	0.184453125	0.184453125
$\sigma < \sigma_0$ or $\sigma > \sigma_0$	$\sigma < \sigma_0$	$\sigma > \sigma_0$
Comment	I is decreasing (Figure 5.4.1 (a))	I is increasing (Figure 5.4.1 (b))

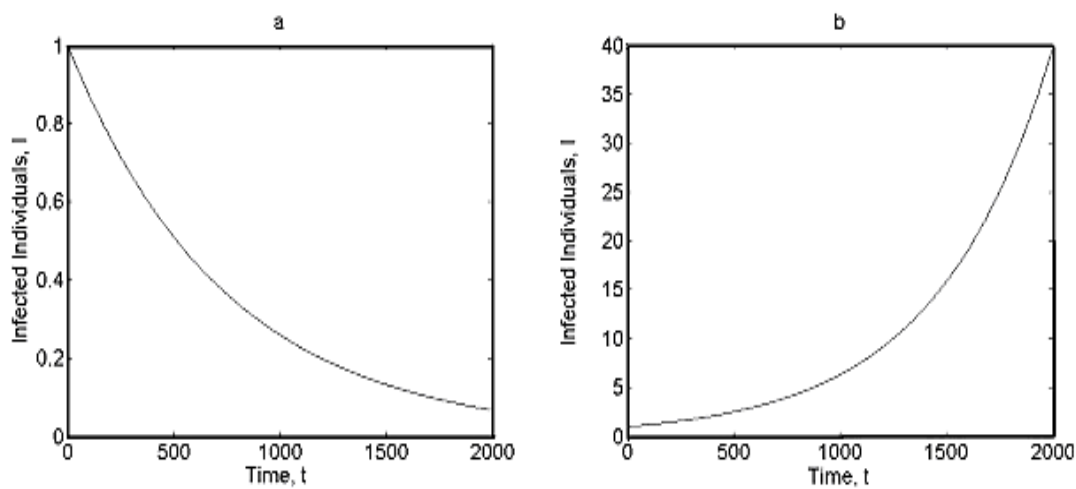

**Fig 5.4.1: Graph of  $I(t)$  for step-1.**



For step 2:

**Table 5.4.2: Results for step-2.**

	<b>Example-1</b>	<b>Example-3</b>
$\phi$ (constant)	0.8	0.8
$\alpha$	0.003	0.007
$\Lambda$ (constant)	0.008	0.008
$\sigma$ (constant)	0.18	0.18
$\mu$ (constant)	0.003	0.003
$\sigma_0$	0.006145408163265	0.006145408163265
$\alpha < \alpha_0$ or $\alpha > \alpha_0$	$\alpha < \alpha_0$	$\alpha > \alpha_0$
Comment	I is decreasing (Figure 5.4.2 (a))	I is increasing (Figure 5.4.2 (b))

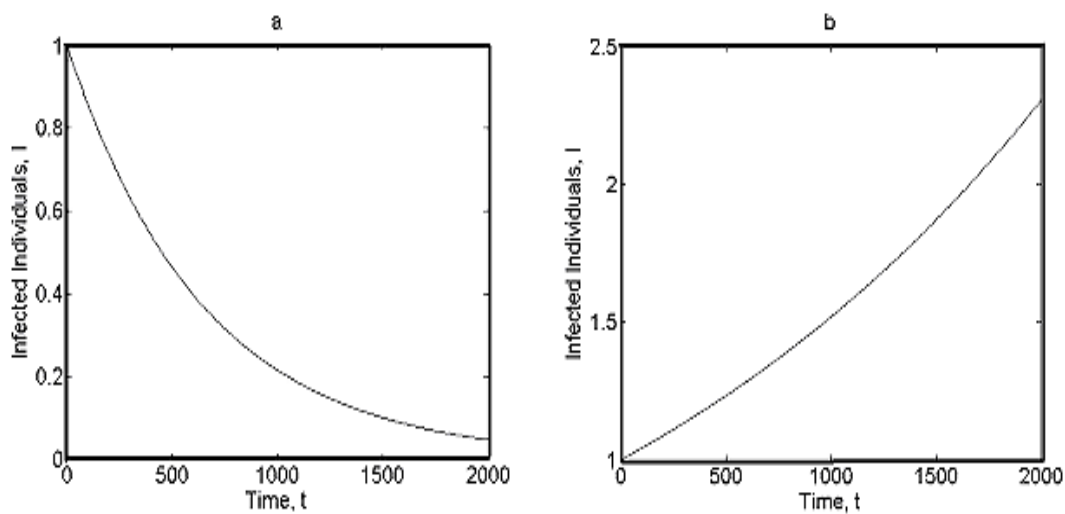

**Figure 5.4.2: Graph of  $I(t)$  for step-2.**

For step 3:

Table 5.4.3: Results for step-3

	Example-1	Example-3
$\phi$ (constant)	0.8	0.8
$\alpha$ (constant)	0.006	0.006
$\Lambda$	0.004	0.009
$\sigma$ (constant)	0.18	0.18
$\mu$ (constant)	0.003	0.003
$\sigma_0$	0.00702332361516	0.00702332361516
$\Lambda < \Lambda_0$ or $\Lambda > \Lambda_0$	$\Lambda < \Lambda_0$	$\Lambda > \Lambda_0$
Comment	I is decreasing (Figure 5.4.3 (a))	I is increasing (Figure 5.4.3 (b))

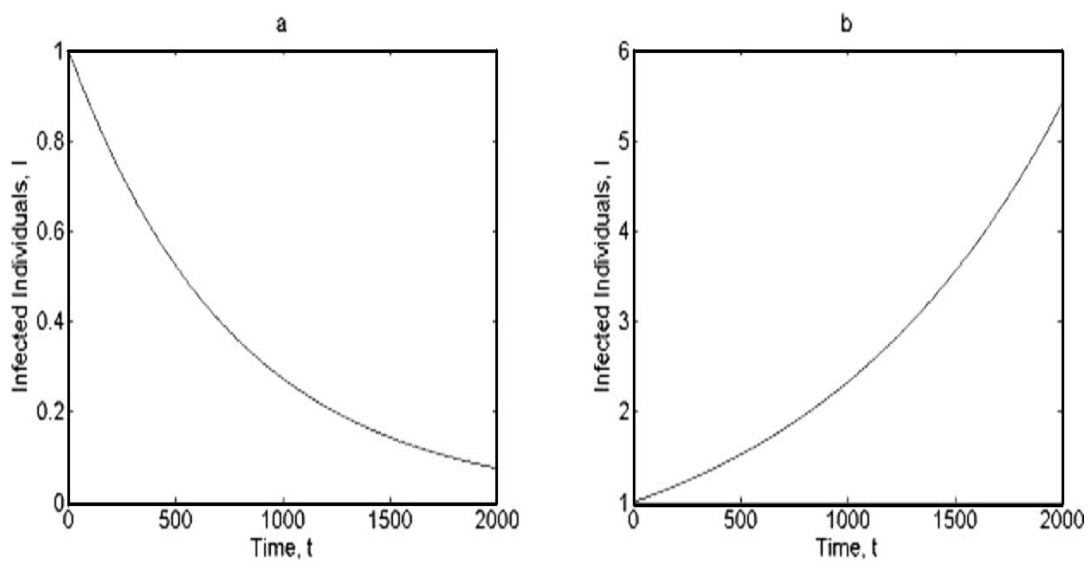
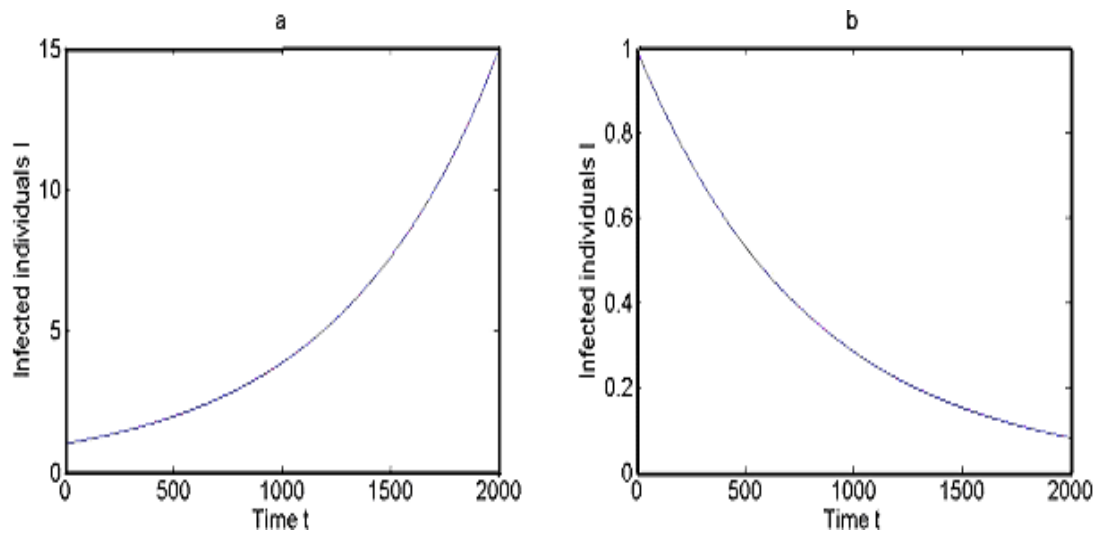

Figure 5.4.3: Graph of  $I(t)$  for step-3.

For step 4:

**Table 5.4.4: Results for step-4**

	Example-1	Example-3
$\phi$	0.1	0.3
$\alpha$ (constant)	0.007	0.007
$\Lambda$ (constant)	0.008	0.008
$\sigma$ (constant)	0.003	0.003
$\mu$ (constant)	0.003	0.003
$\phi_0$	0.015964673913043	0.015964673913043
$\phi < \phi_0$ or $\phi > \phi_0$	$\phi < \phi_0$	$\phi > \phi_0$
Comment	I is increasing (Figure 5.4.4 (a))	I is decreasing (Figure 5.4.4 (b))



**Figure 5.4.4: Graph of  $I(t)$  for step-4.**

### 5.4.3 Discussion

In the above simulations we consider the initial value of infected individual is 1, i.e.,  $I_0 = 1$ . We see from the Table 5.4.1 that if all parameters except  $\sigma$  are fixed, there exist a bifurcation value  $\sigma_0$ . If  $\sigma < \sigma_0$ , then the number of infected individuals is decreasing (Figure 5.4.1 (a)) as  $t \rightarrow \infty$ . On the other hand if  $\sigma > \sigma_0$ , then the number of infected individuals is increasing (Figure 5.4.1 (b)) as  $t \rightarrow \infty$ . Similarly from the Table 5.4.2 we see that if all parameters except  $\alpha$  are fixed, there exist a bifurcation value  $\alpha_0$ . If  $\alpha < \alpha_0$ , then the number of infected individuals is decreasing (Figure 5.4.2 (a)) as  $t \rightarrow \infty$ . On the other hand if  $\alpha > \alpha_0$ , then the number of infected individuals is increasing (Figure 5.4.2 (b)) as  $t \rightarrow \infty$ . From the Table 5.4.3 there exist a bifurcation value  $\Lambda_0$ . If  $\Lambda < \Lambda_0$ , then the number of infected individuals is decreasing (Figure 5.4.3 (a)) as  $t \rightarrow \infty$ . On the other hand if  $\Lambda > \Lambda_0$ , then the number of infected individuals is increasing (Figure 5.4.3 (b)) as  $t \rightarrow \infty$ . Finally from the Table 5.4.4 there exist a bifurcation value  $\phi_0$ . If  $\phi < \phi_0$ , then the number of infected individuals is increasing (Figure 5.4.4 (a)) as  $t \rightarrow \infty$ . On the other hand if  $\phi > \phi_0$ , then the number of infected individuals is decreasing (Figure 5.4.4 (b)) as  $t \rightarrow \infty$ .

### 5.5 Stability analysis of endemic equilibrium

Usually the stability analysis at endemic equilibrium (here  $I > 0$ ) is very difficult.

Now solving (5.3.1), (5.3.2) and (5.3.3) we get

$$S = \frac{\mu(\sigma\alpha + \mu)}{\alpha(\sigma\phi + \sigma\alpha + \mu)}$$

$$V = \frac{\mu\phi}{\alpha(\sigma\phi + \sigma\alpha + \mu)}$$

$$I = \frac{\alpha(\sigma\phi + \sigma\alpha + \mu)\Lambda - (\sigma\alpha\mu + \sigma\alpha\phi + \mu^2 + \mu\phi)\mu}{\alpha\mu(\sigma\alpha + \mu)}$$

i.e., The endemic equilibrium is

$$P^* = \left( \frac{\mu(\sigma\alpha + \mu)}{\alpha(\sigma\phi + \sigma\alpha + \mu)}, \frac{\mu\phi}{\alpha(\sigma\phi + \sigma\alpha + \mu)}, \frac{\alpha(\sigma\phi + \sigma\alpha + \mu)\Lambda - (\sigma\alpha\mu + \sigma\alpha\phi + \mu^2 + \mu\phi)\mu}{\alpha\mu(\sigma\alpha + \mu)} \right)$$

provided  $I^* = \frac{\alpha(\sigma\phi + \sigma\alpha + \mu)\Lambda - (\sigma\alpha\mu + \sigma\alpha\phi + \mu^2 + \mu\phi)\mu}{\alpha\mu(\sigma\alpha + \mu)} > 0$

**Theorem 5.5.1** (Routh–Hurwitz stability criterion) : Given the characteristics polynomial

$$P(\lambda) = \lambda^n + a_1\lambda^{n-1} + a_2\lambda^{n-2} + a_3\lambda^{n-3} + \dots + a_n$$

where the coefficients  $a_i$  are real constant for  $i=1,2,3,\dots,n$ , define the Hurwitz matrices using the coefficients  $a_i$  of the characteristics polynomial as follows

$$H_1 = [a_1], H_2 = \begin{bmatrix} a_1 & 1 \\ a_3 & a_2 \end{bmatrix}, H_3 = \begin{bmatrix} a_1 & 1 & 0 \\ a_3 & a_2 & a_1 \\ a_5 & a_4 & a_3 \end{bmatrix}$$

and

$$H_n = \begin{bmatrix} a_1 & 1 & 0 & 0 & \dots & 0 \\ a_3 & a_2 & a_1 & 1 & \dots & 0 \\ a_5 & a_4 & a_3 & a_2 & \dots & 0 \\ \vdots & \vdots & \vdots & \vdots & \dots & \vdots \\ 0 & 0 & 0 & 0 & \dots & a_n \end{bmatrix}$$

where  $a_j = 0$  if  $j > n$ . All of the roots of the polynomial equation  $P(\lambda) = 0$  are negative or have negative real part iff the determinants of all Hurwitz matrices are positive.

i.e.,  $\det(H_j) > 0$ , for  $j = 1, 2, 3, \dots, n$ .

When  $n = 2$ , the Routh–Hurwitz stability criterion simplify to

$$\det(H_1) = a_1 > 0$$

and

$$H_2 = \begin{bmatrix} a_1 & 1 \\ 0 & a_2 \end{bmatrix} = a_1 a_2 > 0$$

or,  $a_1 > 0$  and  $a_2 > 0$ . For polynomial of degree  $n = 2, 3$  and 4, the Routh–Hurwitz stability criterion is summarized as follows:

$$n = 2: a_1 > 0 \text{ and } a_2 > 0.$$

$$n = 3: a_1 > 0, a_3 > 0 \text{ and } a_1 a_2 > a_3.$$

$$n = 4: a_1 > 0, a_3 > 0, a_4 > 0 \text{ and } a_1 a_2 a_3 > a_3^2 + a_1^2 a_4.$$

In order to study the stability of steady states we consider the equilibrium conditions (5.3.1), (5.3.2), (5.3.2) and the jacobian matrix

$$J = \begin{bmatrix} -\alpha I - \phi - \mu & 0 & -\alpha S \\ \phi & -\mu - \alpha \sigma I & -\sigma \alpha V \\ \alpha I & \sigma \alpha I & \sigma \alpha V + \alpha S - \mu \end{bmatrix}$$

Using the condition (5.3.3), i.e.,  $\sigma\alpha VI + \alpha SI - \mu I = 0$ , i.e.,  $\sigma\alpha V + \alpha S - \mu = 0$ , we get

$$J = \begin{bmatrix} -\alpha I - \phi - \mu & 0 & -\alpha S \\ \phi & -\mu - \alpha\sigma I & -\sigma\alpha V \\ \alpha I & \sigma\alpha I & 0 \end{bmatrix}$$

Again from the equilibrium condition (5.3.1), we get

$$\Lambda - (\alpha I + \phi + \mu)S = 0$$

$$\Rightarrow (\alpha I + \phi + \mu) = \frac{\Lambda}{S}$$

use the above value, we get

$$J = \begin{bmatrix} -\frac{\Lambda}{S} & 0 & -\alpha S \\ \phi & -\mu - \alpha\sigma I & -\sigma\alpha V \\ \alpha I & \sigma\alpha I & 0 \end{bmatrix}$$

Again from the equilibrium condition (5.3.2), we get

$$\phi S - \mu V - \sigma\alpha VI = 0$$

$$\Rightarrow -\mu - \sigma\alpha I = -\frac{\phi S}{V}$$

use the above value, we get

$$J = \begin{bmatrix} -\frac{\Lambda}{S} & 0 & -\alpha S \\ \phi & -\frac{\phi S}{V} & -\sigma\alpha V \\ \alpha I & \sigma\alpha I & 0 \end{bmatrix}$$

After calculating by wxMaxima we get the characteristic equation of the above matrix

as

$$\lambda^3 + \left(\frac{\Lambda}{S} + \frac{\phi S}{V}\right)\lambda^2 + \left(\alpha^2\sigma^2VI + \frac{\phi\Lambda}{V} + \alpha^2SI\right)\lambda + \frac{\alpha^2\sigma^2\Lambda VI}{S} + \frac{\phi\alpha^2S^2I}{V} + \phi\alpha^2\sigma SI = 0$$

$$\Rightarrow \lambda^3 + a_1\lambda^2 + a_2\lambda + a_3 = 0$$

where

$$a_1 = \frac{\Lambda}{S} + \frac{\phi S}{V}$$

$$a_2 = \alpha^2 \sigma^2 VI + \frac{\phi \Lambda}{V} + \alpha^2 SI$$

$$a_3 = \frac{\alpha^2 \sigma^2 \Lambda VI}{S} + \frac{\phi \alpha^2 S^2 I}{V} + \phi \alpha^2 \sigma SI$$

By the Routh-Hurwitz criterion, the endemic equilibrium is stable if and only if

$$a_1 > 0, a_3 > 0 \text{ and } a_1 a_2 - a_3 > 0$$

Clearly

$$a_1 = \frac{\Lambda}{S} + \frac{\phi S}{V} > 0$$

and

$$a_3 = \frac{\alpha^2 \sigma^2 \Lambda VI}{S} + \frac{\phi \alpha^2 S^2 I}{V} + \phi \alpha^2 \sigma SI > 0$$

So the endemic equilibrium is stable iff  $a_1 a_2 - a_3 > 0$

$$\text{i.e., } \left( \frac{\Lambda}{S} + \frac{\phi S}{V} \right) \left( \alpha^2 \sigma^2 VI + \frac{\phi \Lambda}{V} + \alpha^2 SI \right) - \left( \frac{\alpha^2 \sigma^2 \Lambda VI}{S} + \frac{\phi \alpha^2 S^2 I}{V} + \phi \alpha^2 \sigma SI \right) > 0$$

$$\text{i.e., } \frac{((\phi \alpha^2 \sigma^2 - \phi \alpha^2 \sigma) IS^2 + \alpha^2 \Lambda SI) V^2 + \phi \Lambda^2 V + \phi^2 \Lambda S^2}{SV^2} > 0$$

$$\text{i.e., } ((\phi \alpha^2 \sigma^2 - \phi \alpha^2 \sigma) IS^2 + \alpha^2 \Lambda SI) V^2 + \phi \Lambda^2 V + \phi^2 \Lambda S^2 > 0$$

where

$$\Lambda - \alpha SI - \phi S - \mu S = 0$$

$$\phi S - \mu V - \sigma \alpha VI = 0$$

$$\sigma \alpha V + \alpha S - \mu = 0$$



## 5.6 Conclusion

In this chapter a new deterministic epidemic model is constructed and used to analyze the effect of a preventive vaccine on the transmission dynamics of an infectious disease. The model is thoroughly analyzed to investigate the stability. From the theoretical discussion and numerical simulations for the DFE, we see that if the parameters satisfy any of the equivalent conditions  $\sigma < \sigma_0$ ,  $\alpha < \alpha_0$ ,  $\Lambda < \Lambda_0$  and  $\phi > \phi_0$  then there is no epidemic. So, in the initial stage (when the number of infected individuals is not large), we shall control the epidemic successfully by controlling the parameters. Also for the endemic equilibrium we give a condition for stability (if there exist endemic equilibrium).

# CHAPTER SIX

## CONCLUSION

The purpose of this study was to take a close look at the endemic behavior of the diseases of SIS and SI type models. The study was included the infective immigrant and the disease-related death in the simple SVIS model. The result of mathematical analysis indicated that a vaccination campaign had an effect of reducing reproductive number. The findings indicated that the average number of secondary infective caused by an average earlier infective becomes smaller when vaccination is in effect. Furthermore, in SVIS models a vaccination campaign meant to reduce disease's reproductive number below one but failed to control the disease when there is a backward bifurcation. Bringing down the vaccination reproductive number just below one may not be good enough to eradicate the disease in such a case. If there is no infective immigrant, a typical transcritical bifurcation is observed. The disease-free equilibrium and endemic equilibrium coincided at  $R(\phi) = 1$  and they exchanged the stability at that point.

The study also analyzed the effect of a preventive vaccine on the transmission dynamics of infectious diseases in SVI model. The model was thoroughly analyzed to investigate the stability of equilibrium points. This model has a DFE, so the basic reproductive number  $R_0$  has been defined. The disease free equilibrium is stable when  $R_0 < 1$ . In this study  $R_0$  has been considered as a function of one parameter to calculate the condition for  $R_0 < 1$ . From the theoretical discussion and numerical

simulations at the DFE, it was found that if the parameters satisfy any of the equivalent conditions  $\sigma < \sigma_0$ ,  $\alpha < \alpha_0$ ,  $\Lambda < \Lambda_0$  or  $\phi > \phi_0$  then  $R_0 < 1$ , *i.e.*, there is no epidemic. So, at the initial stage of identifying infected individuals it is easy to control the epidemic successfully by controlling the parameters. Finally a condition was given for stability of endemic equilibrium if there exists endemic equilibrium in SVI model.

## BIBLIOGRAPHY

- Abbas A., Murphy, K., & Sher, A. (1996). Functional diversity of helper Tlymphocytes. *Nature*, 383, 787-793.
- Agarwal, M., & Verma, V. (2012). Stability and hopf bifurcation analysis of a SIRS epidemic model with time delay. *Int. J. of Appl. Math and Mech*, 8(9), 1-16.
- Agur, Z. (1985). Randomness synchrony and population persistence. *J. Theol: Biol.*, 112, 677-693.
- Agur, Z., & Deneubourg , J. L. (1985). The effect of environmental disturbance on the dynamics of marine intertidal populations. *Theol: Pop. Biol.*, 27, 75-90.
- Akinwande (2006). A mathematical of the dynamics of the HIV/AIDS disease pandemic. *J .Nig. Math.Soc.*, 25, 99-108.
- Alexander M. (2006). Analysis, *Modeling and Simulation of Multiscale Problems*, Springer-Verlag, Berlin.
- Allen, L. (2003). *An Introduction to Stochastic Processes with Applications to Biology*. Pearson Education- Prentice Hall, New Jersey.
- Anderson, R., & May, R. (1991). *Infectious Diseases of Humans: Dynamics and Control*. Oxford University Press, Oxford.
- Anderssson, H., & Britton, T. (2000). *Stochastic Epidemic Models and Their Statistical Analysis, Lecturer Notes in Statistics*. Springer-Verlag, New York.

- Arino, J., McCluskey, C.C., & Driessche, P.V.D. (2003). Global results for an epidemic model with vaccination that exhibits backward bifurcation. *SIAM J. Appl. Math.*, 64, 260–276.
- Bagasra, O., Hauptman, S., Lischner, H., Sachs, M., & Pomerantz, R. (1992). Detection of human immunodeficiency virus type 1 provirus in mononuclear cells by in situ polymerase chain reaction. *N Engl J Med*, 326, 1385-1391.
- Bailey, N. (1975). *The Mathematical Theory of Infectious Disease and its Applications*, Griffin, London.
- Baruer, F., & Castillo-Chavez, C. (2001). *Mathematical Models in Population Biology and Epidemiology*. Springer-Verlag, New York.
- Belteami, E. (1989). *Mathematics for dynamic modeling*. Academic Press. New York.
- Brauer, F., & Van Den Driessche, P. (2001). Models for transmission of disease with immigration of infectives. *Math. Biosci.*, 171(2), 143–154.
- Buonomo, d’Onofrio, B. A., & Lacitignola, D. (2008). Global stability of an SIR epidemic model with information dependent vaccination, *Mathematical Biosciences*, 216, 9–16.
- Burghes, D.N., & Borrie, M.S. (1981). *Modeling with differential equations*. Halsted Press, Newark.
- Busenberg, S., & Cooke, K. (1993). *Vertically Transmitted Diseases*. Springer-Verlag, New York.

- Calloway, D.S., & Perelson, A.S. (2002). HIV-1 infection and low steady state viral loads. *Bulletin of Mathematical Biology*, 64, 29-64.
- Capasso, V. (1993). Mathematical Structures of Epidemic Systems. *Lecturer Notes in Biomathematics*, Springer-Verlag, Berlin.
- Castillo-Chavez, C., Blower, S., Kirschner, D., Driessche, V.D.P., & Yakubu, A. (2002). Mathematical Approaches for Emerging and Re-emerging Infectious Diseases, An Introduction. *IMA Series in Mathematics and Its Applications*. Springer-Verlag, New York.
- Chin, J. (2002). *Control of Communicable Diseases Manual, 17<sup>th</sup> Ed.* American Public Health Association, Washington, DC.
- Clerici, M., & Shearer, G. (1993). A TH1 to TH2 switch is a critical step in the etiology of HIV infection. *Immunology Today*, 14, 107-111.
- Daley, D.J., & Gani, J. (1999). *Epidemic modeling: an introduction Cambridge Studies in Mathematical Biology*. Cambridge University Press, Cambridge.
- Diekmann, O., & Heesterbeek (2000). *Mathematical Epidemiology of Infectious Diseases*. Wiley, New York.
- Diekmann, O., Heesterbeek, J.A.P., & Metz, J.S.J. (1990). On the definition and the Computation of the basic reproduction number ratio  $R_0$  in models for infectious diseases in heterogeneous population. *J. Math. Bio* 28, 365- 382.

- Driessche, P.V.D., & Watmough, J. (2002). Reproduction numbers and sub-threshold endemic equilibria for compartmental models of disease transmission, *Mathematical Bioscience*, 180, 29-48.
- Edelstein, L. (2005). *Mathematical model in Biology, Society of industrial and applied Mathematics*. Siam Random House, New York., USA.
- F. Brauer, F., & Nohel, J.A. (1989). *The qualitative theory of ordinary differential equations: an introduction*. Dover Publications, New York.
- Fall, A., Iggidr, A., & Sallet, G. (2007). Epidemiological Models and Lyapunov Functions. *Mathematical Modelling of Natural Phenomena*, 2(1), 55-73.
- Fister, K., Lenhart, S., & McNally, J. (1998). Optimizing chemotherapy in an HIV model. *Elect J Diff Equations*, 32, 1-12.
- Gerard, L., & Joseph, D. (1990). *Elementary stability and bifurcation theory, second edition*. Springer-Verlag, New York.
- Ghani A.C., Henley, W.E. and Mayer, S. (2001). Comparison of the effectiveness of non-nucleoside reverse transcriptase inhibitor- containing regimens using observational databases. *J. AIDS*, 15 (9), 1133-1142.
- Giannakopoulos, F., & Zapp, A. (2001). Stability and hopf bifurcation in differential equations with one delay. *Nonlinear dynamics and systems theory*, 1(2), 145–158.
- Grenfell, B., & Dobson, A. (Editors) (1995). *Ecology of Infectious Diseases in Natural Populations*. Cambridge University Press, Cambridge.

- Guckenheimer, J., & Holmes, P.J. (1983). *Nonlinear Oscillations, Dynamical Systems, and Bifurcations of Vector Fields*. Springer-Verlag, New York,.
- Guihua, L., & Zhen, J. (2005). Global stability of a SEIR epidemic model with infectious force in latent, infected and immune period. *Chaos, Solitons & Fractals (Elsevier)*. 25, 1177-1180.
- Heffernan, J.M., & Keeling, M.J. (2009). Implications of vaccination and waning immunity. *Proc. R. Soc.*, 270, 2071-2080.
- Herz, A., Bonhoeffer, S., Anderson, R., May, R., & Nowak, M. (1996). Viral dynamics in vivo: Limits on estimates of intracellular delay and virus decay. *Proc Natl Acad Sci USA*, 93, 7247-7251.
- Hethcote, H.W. (1976). Qualitative analyses of communicable disease models. *Math. Biosci.*, 28, 335-356.
- Hethcote, H.W. (2000). The Mathematics of Infectious Diseases. *Society for Industrial and Applied Mathematics*, 42(4), 599-653.
- Hethcote, H.W., & Yorke, J. (1984). Gonorrhea Transmission Dynamics and Control, Vol. 56. *Lecture Notes in Biomathematics*. Springer-Verlag, Berlin.
- Hsieh, Y.H. (1996). A two sex model for the treatment of AIDS, its behavior change in a population of Varying sizes. *IMA J. Maths., Applied Bio. Med.*, 13, 151-173.



- Huang, Y., Rosenkaraanz, S.L., & Wu, H. (2003). Modeling HIV dynamics and antiviral response with consideration of time- varying drug exposures, adherences and phenotypic sensitivity. *Math. Biosci.*, 184, 165-186.
- Ibrahim, H.I.A., & Witbooi P.J. (2012). Modeling the dynamics of an epidemic under vaccination in two interacting populations. *Journal of applied mathematics*. 2012, Article ID 275902.
- Janeway, C.A., & Travers, P. (2006). *Immunology: the Immune System in Health and Disease. 6th ed.* Garland Publishing, New York.,.
- Jianwen, J. (2011). Global Analysis of an SVEIR Epidemic Model with Partial Immunity. *Mathematica Aeterna*. 1(08), 547 -561.
- Jordan, D.W., & Smith, P. (1977). *Nonlinear ordinary differential equations*. Oxford University Press, Oxford.
- Junfeng, W., & Yakui, X. (2011). Bifurcation analysis of a stage-structured epidemic model with a nonlinear incidence. *International journal information and systems sciences*. 7(1), 61–72.
- Kapur, J.N. (1998). *Mathematical Modeling, 1st Edition*. Taj Press, New Dilli.
- Kermack, W.O., & McKendrick, A.G. (1927). A contribution to the mathematical theory of epidemics. *Proceedings of the Royal Society of London. Series A*, 115, 700–721.
- Kimbir, R.A., Udoo,2M.J. I., & Aboiyar, T. (2012). A mathematical model for the transmission dynamics of HIV/AIDS in a two-sex population considering counseling and antiretroviral therapy (ART). *J. Math. Comput. Sci*. 2(6), 1671-1684.

- Kimbir, R.A. (2003). Mathematical model for the prevention of HIV/ AIDS in a varying population, *J.Nig. Math.soc.* 22, 43-55.
- Kirschner, D., & Webb, G. (1996). Immunotherapy of HIV-1 infection. *J Biol Sys*,6(1), 71-83.
- Kirschner, D., Lenhart, S., & Serbin, S. (1997). Optimal control of the chemotherapy of HIV. *J Math Biol* , 35, 775-792.
- Kirschner, D., Webb, G., & Cloyd, M. (2000). Model of HIV-1 disease progression based on virus-induced lymph node homing and homing-induced apoptosis of CD4+ lymphocytes. *J. AIDS*, 24, 352-362.
- Klein, S.A., Dobbmeyer, J.M., Dobbmeyer, T.S., Pape, M., Ottmann, O.G., Helm, E.B.,...,Rossol, R. (1997). Demonstration of the Th1 to Th2 cytokine shift during the course of HIV-1 infection using cytoplasmic cytokine detection on single cell level by flow cytometry. *J. AIDS*, 11, 1111-1118.
- Kribs-Zaleta, C.M., & Vekasco-Hernandez, Z.X. (2000). A simple vaccination model with multiple endemic states. *Mathematical Biosciences*, 164, 183-201.
- Maggi, E., Mazzetti, M., Ravina, A., Annunziato, F., Carli, M., Piccinni, M.P.,...Prete G. (1995). Ability of HIV to promote a Th1 to Th2 shift and to replicate preferentially in Th2 and Th0 cells. *Science*, 265, 244-248.
- Manuel, D.S., Ibeas, A., Alonso-quesada, S., & Nistal, R. (2011). On the equilibrium points, boundedness and positivity of a sveirs epidemic model under constant regular constrained vaccination. *Informatica*, 22(3), 339–370.

- Marshall, H., Merchant, K., & Stamler, J. (2000). Nitrosation and oxidation in the regulation of gene expression. *FASEB*, 14, 1889-1900.
- Masur, H, Michelis, M.A, Greene, J.B, Onorato, I, Stouwe, R.A, Holzman, R.S, ... Cunningham-Rundles, S.(1981). An outbreak of community acquired *Pneumocystis carinii* pneumonia. *N Engl J Med* , 305(24), 1431-1438.
- McLean, A., & Kirkwood, T. (1990). A model of human immunodeficiency virus infection in T helper cell clones. *J Theor Biol*, 147, 177-203.
- McLean, A., & Nowak, M. (1992). Models of interaction between HIV and other pathogens. *J Theor Biol*, 155, 69-102.
- Meng, F., Michael, Y., & Wang, K. (2001). Global stability of an SEIS epidemic model with recruitment and varying total population size. *Mathematical bioscience*, 170, 199-208.
- Mildvan, D., Mathur, U., Enlow, R.W., Paul L., Romain, M.D.,...Spigland, I. (1982). Opportunistic infections and immune deficiency in homosexual men. *Ann Intern Med*, 96, 700-704.
- Mittler, J., Sulzer, B., Neumann, A., & Perelson, A. (1998). Influence of delayed viral production on viral dynamics in HIV-1 infected patients. *Math Biosci*, 152, 143-163.
- Mossman, T. (1004). Cytokine patterns during the progression to AIDS. *Science*, 265, 193-194.

- Murray, J.D. (2002). *Mathematical Biology I. An introduction, 3<sup>rd</sup> edi.* Springer, New York.
- Murray, J.D. (2002). *Mathematical Biology II. Spatial models and biomedical applications, 3<sup>rd</sup> edi.* Springer, New York.
- Nakul C., Cushing, J.M., & Hyman J.M. (2006). Bifurcation Analysis of a Mathematical Model for Malaria Transmission. *Society for Industrial and Applied Mathematics*, 67(1), 24–45.
- Nelson, P., Murray, J., & Perelson, A.A. (2000). Model of HIV-1 pathogenesis that includes an intracellular delay. *Math Biosci.*, 163, 201-215.
- Nelson, P.W., & Perelson, A.S. (2002). Mathematical analysis of delay differential equation models of HIV-Infection. *Math. Biosci.*, 171(1), 73-94.
- Nelson, P.W., Murray, J.D., & Perelson, A.S. (2000). A model of HIV-1 pathogenesis that includes an intracellular delay. *Mathematical Biosciences*. 163, 201-215.
- Nowak, M., & May, R. (1991). Mathematical biology of HIV infections: antigenic variation and diversity threshold. *Math Biosci.*, 106, 1-21.
- Pakke,r N.G., Notermans, D.W., Boer, R.J., Roos, M.T, Wolf, F,... Schellekens, P.T. (1998). Biphasic kinetics of peripheral blood T cells after triple combination therapy in HIV infection: a composite of redistribution and proliferation. *Nature medicine*, 4, 208-214.
- Perelson, A., Kirschner, D., & Boer, R. (1993). Dynamics of HIV infection of CD4+T cells. *Mah Biosci*, 114, 81-125.

- Perko, L. (1983). *Differential equations and dynamical systems, Texts in Applied Mathematics, Vol.7*. Springer-Verlag, New York,.
- Peterson, J., Herzenberg, L., Vasquez, K., & Waltenbaugh, C. (1998). Glutathione levels in antigen-presenting cells modulate Th1 versus Th2 response patters. *Proc Natl Acad Sci USA*, 95, 3071-3076.
- Piatak, M.J., Saag, M.S., Yang, L.C., Clark, S.J., Kappes, J.C., Luk, K.C.,..., Lifson, J.D. (1993). High Levels of HIV-1 in plasma during all stages of infection determined by quantitative competitive PCR. *Science*, 259, 1749-1754.
- Reisler, R., Han, C., Burmann,W., Tedaldi, E., & Neaton, J. (2003). Grade 4 events as important as AIDS events in the era of HAART. *J AIDS*, 34, 379-386.
- Rodríguez, B., Sethi, A.K., Cheruvu, V.K., Mackay, W., Bosch, R.J., Kitahata, M.,..., Lederman, M.M. (2006). Predictive value of plasma HIV RNA level on rate of CD4 T-cell decline in untreated HIV infection. *JAMA*, 296, 1523-1525.
- Roederer, M. (1998). Getting to the HAART of T cell dynamics. *Nature Medicine*, 4, 145-146.
- Root-Bernstein, R. (1997). The necessity of cofactors in the pathogenesis of AIDS: a mathematical model. *J Theor Biol*, 187, 135-146.
- Ruan, S., & Wang, W. (2003). Dynamical behavior of an epidemic model with a nonlinear incidence rate. *J. Differential Equations*, 188, 135–163.

- Schacker, T.W., Hughes, J.P, Shea, T., Coombs, R.W., & Core, L. (1998). Biological and virologic characteristic of primary HIV infection. *Ann.Intern.Med*, 128 (8), 613-620.
- Shelburne, S., Mones, M., & Hamill, R. (2006). Immune reconstitution inflammatory syndrome:more answers, more questions. *J Antimicrob Chemother*, 57, 167-170.
- Sheppard, W., Ascher, M., & Krowka, J. (1993). Viral burden and HIV disease. *Nature*, 364, 291-292.
- Smith, R.J., & Wahl, L.M. (2004). Distinct effects of protease and reverse Transcriptase inhibition in an immunological model of HIV-1 infection with impulsive drug effects. *Bull. Math. Bio.* 66 (5), 1259-1283.
- Soper, H.E. (1929). Interpretation of periodicity in disease prevalence. *J. roy. Stat. Soc., Series B*, 92, 34-73.
- Sotomayor, J. (1973). *Generic bifurcations of dynamical systems*. Academic Press, New York.
- Wahl, L.M., & Nowak, M.A. (2000). Adherence and drug resistance: predictions for therapy outcome. *Proceedings of the Royal Society of London. Series B*, 267, 835-843.
- Waziri, A.S., Massawe, E.S., & Makinde, O.D. (2012). Mathematical modelling of HIV/AIDS dynamics with treatment and vertical transmission. *Applied Mathematics*, 2(3), 77-89.

- Wein, L., Amato, R., & Perelson, A. (1998). Mathematical analysis of antiretroviral therapy aimed at HIV-1 eradication or maintenance of low viral loads. *J. Theor Biol*, 192, 81-98.
- Wein, L., Zenios, S., & Nowak, M. (1997). Dynamic multidrug therapies for HIV: a control theoretic approach. *J Theor Biol*, 185, 15-29.
- Wiggins, S. (1990). *Introduction to Applied Nonlinear Dynamical Systems and Chaos, Texts in Applied Mathematics, Vol.2*. Springer-Verlag, New York.
- Wodarz, D., & Nowak, M. (1999). Specific therapies could lead to long- term immunological control of HIV. *Proc Natl Acad Sci USA*, 96, 464-469.
- Xiefei, Y., & Yun, Z. (2009). Control of epidemics by quarantine and isolation strategies in highly mobile populations. *International journal of information and systems sciences* , 5(3), 271-286.
- Yang, W., Chengjun, S., & Arino, J. (2010). Global analysis for a general epidemiological model with vaccination and varying population. *J. Math. Anal. Appl.*, 372, 208–223.
- Zhixing, H., Ping, B., Wanbiao, M., & Shigui, R. (2011). Bifurcations of an SIRS epidemic model with nonlinear incidence rate. *Discrete and continuous dynamical systems series B*, 15(1), 93-112.
- Zhou, X., & Guo, Z. (2012). Analysis of an influenza a (H1N1) epidemic model with vaccination. *Arab J Math*, 1, 267–282.